

MONTAGEANLEITUNG

GB	Assembly instructions	Pavilion
F	notice de montage	Pavillon
I	istruzioni di montaggio	Padiglione
E	Instrucciones de montaje	Pabellón
P	Instruções de montagem	Pavilhão
H	szereelési utasítás	pavilon
NL	montagehandleiding	paviljoen
HR	uputstvo za montažu	paviljon
SLO	navodilo za uporabo	Paviljon

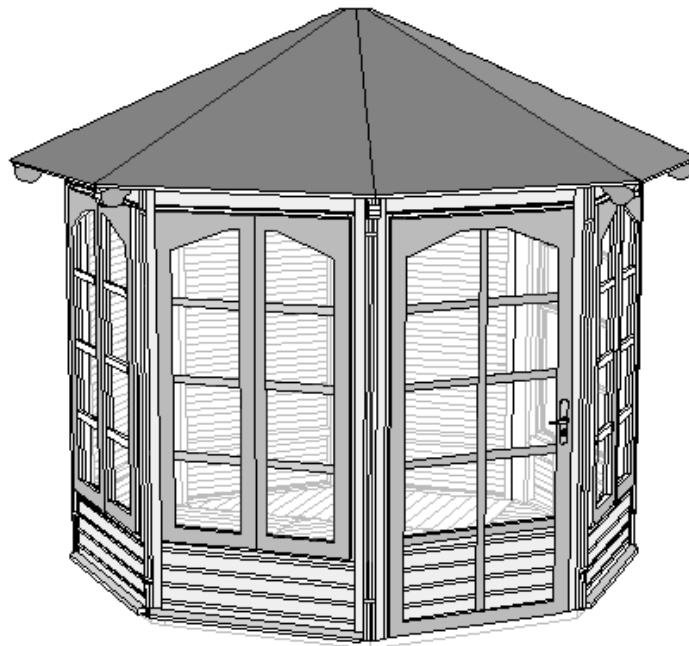

8-ECK - PAVILLON

ART.-NR. 234.2828.20.00
234.2828.30.00

STAND 806



Sehr geehrte Kundin, sehr geehrter Kunde,
danke, daß Sie sich für ein weka – Produkt entschieden haben.

- Lesen Sie diese Anleitung vor dem Aufbau bitte vollständig durch, um Montagefehler oder Beschädigungen zu vermeiden.
- **WICHTIG !**
Prüfen Sie bitte sofort anhand der Packliste, ob das weka-Produkt vollständig und unbeschädigt bei Ihnen angekommen ist.
- Bitte vernichten Sie die Packliste erst nach Ablauf der Garantiezeit. Diese Liste dient Ihnen zur Kontrolle auf Vollständigkeit der Einzelteile und ist mit dem Kaufbeleg aufzubewahren. Eventuelle Beanstandungen können mit Hilfe dieser Liste problemlos behoben werden. Die Pos.-Nummern der Packliste stimmen nicht mit den Pos.-Nummern folgender Montageanleitung überein.
- Wir empfehlen Ihnen die Montage mit 3 Personen durchzuführen.
- Zur Verhütung von Unfällen ist zu vermeiden, daß sich Kinder während der Montage in unmittelbarer Nähe befinden.
- Weiterentwicklungen im Sinne des technischen Fortschritts behalten wir uns vor. So können geringfügige Abweichungen in den Darstellungen entstehen.
- Verpackungsmaterial nicht einfach wegwerfen! Papier-, Pappe- und Wellpappeverpackungen, sowie Kunststoffverpackungsteile sollten in die entsprechenden Sammelbehälter gegeben werden.

EMPFEHLUNGEN

- Bitte bohren Sie alle Schraubverbindungen vor, um Beschädigungen an den Holzteilen zu vermeiden! Folgendes Zeichen macht Sie während der Anleitung nochmals darauf aufmerksam:



- Schützen Sie das Holz vor und während des Aufbaus vor stundenlangem, direkter Sonneneinwirkung oder Feuchtigkeit.
- Holz ist ein Naturprodukt. Verschiedenartige Färbungen, Äste und Rißbildung sind normal und haben keinen Einfluß auf die Statik.
- Voraussetzung für die fachgerechte Montage ist ein absolut ebenes Fundament. Wir empfehlen Ihnen ein Plattenfundament.
- Gegen Windschäden ist der Pavillon mit dem Fundament zu verankern. Hierzu eignen sich im Fachhandel erhältliche Betonanker oder Stahlwinkel, mit denen der Grundrahmen auf dem Fundament befestigt wird. Die Verankerung gehört nicht zum Lieferumfang.
- Um aufsteigende Feuchtigkeit zu verhindern, empfehlen wir, zwischen dem Fundament und dem Grundrahmen eine Sperrschicht aus Dachpappe o.ä. zu verlegen. Sperrschicht aus Dachpappe ist nicht im Lieferumfang enthalten.
- Grundsätzlich sollten Sie einen Fachmann für Holzanstrichmittel konsultieren!
- Wir empfehlen Ihnen alle Holzbauteile vor der Montage mit Bläuesperrgrund zu behandeln.
- Der Grundrahmen ist vor der Montage mit einem Holzschutzmittel zu streichen!
- **Nach Fertigstellung geben Sie dem gesamten Pavillon einen mehrfachen Schutanstrich (mindestens zwei Anstriche) einer offenporigen Holzschutzlasur.**
- Ein regelmäßiger Anstrich gemäß der Herstellerangaben der Holzschutzlasur ist zum Schutz des Holzes notwendig.
- Bei langanhaltenden Schneefällen ist das Dach vom Schnee zu befreien!

GARANTIEBESTIMMUNGEN

Die Firma weka Holzbau GmbH gewährt Ihnen 5 Jahre Garantie auf Konstruktion und Verarbeitungsqualität. Innerhalb der Garantiezeit werden fehlerhafte Teile kostenlos ersetzt. Die durch den Austausch entstehenden Kosten sind im Garantieanspruch nicht enthalten.

Garantieansprüche können nur in Verbindung mit Original-Packlisten und Kaufbeleg in Anspruch genommen werden.

Von der Garantie sind Mängel ausgeschlossen, die bedingt sind durch:

- unsachgemäße Fundamente und Gründungen
- nicht gemäß dieser Anleitung durchgeführten Montage
- Schneelasten, bitte die Dachhaut bei Schneefall beräumen
- eigene Veränderungen am Produkt
- fehlerhafte Pflege zur Erhaltung der vorhandenen Holzqualität
- das Vorherrschen von Windgeschwindigkeiten über Windstärke 7 (steifer Wind)
Im Binnenland sind hierbei Auswirkungen wie z.B. die Bewegung ganzer Bäume und die fühlbare Hemmung beim Gehen im Freien zu beobachten. Bei Verursachung von Mängeln aufgrund dieser Bedingungen wird keine Gewährleistung übernommen.
- Naturkatastrophen oder anderweitige gewaltsame Einwirkungen.

Bei Farbveränderungen, Rißbildung, Verzug oder ähnlichen Veränderungen, die bei Hölzern im Freien normal sind, besteht kein Reklamationsgrund.

Weitergehende Ansprüche und Folgeschäden fallen nicht unter die Garantiebestimmungen. Es gelten unsere allgemeinen Geschäftsbedingungen.

WERKZEUG

Folgendes Werkzeug sollten Sie vor Beginn der Montage zurecht gelegt haben.
(Nicht im Lieferumfang enthalten!)

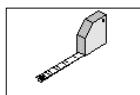

Bandmaß

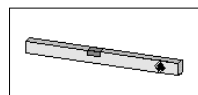

Wasserwaage



Stift

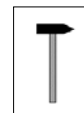

Hammer

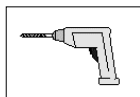

Bohrmaschine



Elektroschrauber

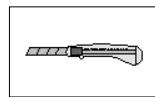

Universalmesser

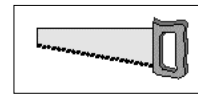

Säge

ABKÜRZUNGEN

- **F** = Fenster
- **W** = Windschutz
- **T** = Tür

GB

Dear customer

Thank you very much for choosing a weka product.

- Read these instructions through completely before assembling your product in order to avoid errors in assembly or damage.
- **IMPORTANT**
Please use the enclosed packing list to check immediately that your weka product has been delivered complete and intact.
- Please do not dispose of the packing list before the guarantee period has expired. This list enables you to check that all the individual parts are present. It should be retained along with the proof of purchase. Any complaints which may arise can probably be easily rectified with this list. The item numbers on the packing list do not correspond to the item numbers in the following assembly instructions.
- We recommend that 3 people carry out the assembly.
- In order to prevent accidents, we recommend that children are kept out of the direct vicinity during assembly.
- We reserve the right to make further technological developments. This means that there may be minor deviations in the illustrations.
- Please do not simply throw away the packaging material. Paper, card and corrugated board as well as plastic packaging materials should be placed in the correct collection containers.

RECOMMENDATIONS

- Please drill pilot holes for all screw connections to avoid damaging the wood. The following symbol in the instructions will indicate when this is necessary:



- Before and during assembly, protect untreated wood from direct sunlight or moisture.
- Wood is a natural product. Fluctuations in colour, knots and cracks are normal and have no influence on the statics.
- A prerequisite for professional assembly is an absolutely level foundation. We recommend a raft foundation.
- An absolutely level foundation is required for expert assembly. We recommend a raft foundation.
- The pavilion must be anchored to the foundation to protect against wind damage. The fixing materials are not included in the delivery.
- In order to avoid rising damp, we recommend that a barrier layer using the packaging film, roofing paper or similar be laid between the foundation and the floor beams. Roofing paper for a barrier layer is not included in the scope of this delivery.
- In principle, you should consult an expert in wood protection agents.
- We recommend that you treat all wooden components with blue stain prior to assembly.
- The base frame is to be coated with a wood protection agent prior to assembly.
- **After completion, give the entire pavilion several coats (at least two) of a porous wood protection scumble.**
- A regular application of wood protection scumble in accordance with the manufacturer's instructions is required to protect the wood.

GUARANTEE CONDITIONS

weka Holzbau GmbH provides you with a 5-year guarantee for design and processing quality. Within the guarantee time, faulty parts will be replaced free of charge. Costs arising as a result of the exchange are not included in the guarantee claim.

Guarantee claims may only be made in conjunction with the original packing list and proof of purchase.

Excluded from the guarantee are defects caused by:

- improper subsoil and foundations
- assembly not carried out in accordance with these instructions
- snow load in excess of 0,75 kN/m²
- your own alterations to the product
- defective care in the maintenance of the current wood quality
- prevailing winds in excess of force 7 (stiff wind)

Inland, consequences such as the movement of whole trees and any noticeable impedance when walking in the open air are to be observed. No defects due to these conditions will give rise to a guarantee.

- Natural catastrophes or other violent occurrences.

Fluctuations in colour, crack formation, warping or similar changes which are completely normal outdoors are no grounds for making a claim.

Further claims and consequential damage do not fall under the guarantee regulations. Our General Terms and Conditions apply.

TOOL

You should have the following tools to hand before beginning assembly.

Not supplied.

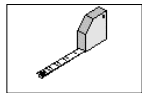

Spring tape measure

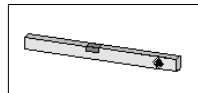

Spirit level



Pencil

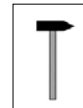

Hammer

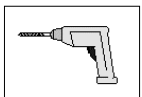

Drill



Electric screwdriver

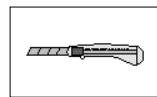

Universal cutter

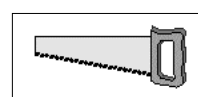

Mitre saw/hand disk saw

ABBREVIATIONS

- **F** = Window
- **W** = wind protection
- **T** = Door

F

Chère Cliente, cher Client

Nous vous remercions d'avoir choisi un produit weka.

- Lisez entièrement la présente notice avant de procéder à l'assemblage afin d'éviter les erreurs et les dommages.
- **IMPORTANT !**
Veillez vérifier immédiatement, à l'aide de la liste des pièces, si le produit weka est arrivé complet et en bon état.
- Ne détruisez la liste des pièces qu'une fois la garantie écoulee. Cette liste vous permet de vérifier si les pièces détachées sont complètes et doit être conservée avec le justificatif d'achat. Elle vous permettra de faire valoir aisément d'éventuelles réclamations. Les numéros de pos. de la liste des pièces ne sont pas identiques aux numéros de pos. de la présente notice de montage.
- Nous vous recommandons d'effectuer le montage à 3 personnes.
- Afin de prévenir tout accident, éviter la présence d'enfants à proximité durant le montage.
- Nous nous réservons le droit d'apporter aux produits des modifications dans le cadre de l'évolution technique. De légères différences sont par conséquent possibles par rapport aux illustrations.
- Ne pas jeter simplement le matériel d'emballage! Les emballages en papier, carton et carton ondulé doivent être déposés dans le container de tri correspondant.

RECOMMANDATIONS

- Pré-percez tous les assemblages vissés afin d'éviter d'endommager les éléments en bois! Ceci vous est rappelé par le symbole suivant dans la notice:



- Protégez le bois non traité du soleil et de l'humidité avant et durant le montage!
- Le bois est un produit naturel. Les différentes colorations, les nœuds et les fissures sont normaux et n'ont aucun effet sur la tenue statique.
- La fondation doit être parfaitement plane pour un montage dans les règles. Nous vous recommandons une fondation en table.
- L'exécution du montage dans les règles suppose la présence d'une fondation parfaitement plane. Nous recommandons une fondation à plaques.
- Le pavillon doit être ancré à la fondation pour prévenir les dommages dus au vent. Le matériel de fixation n'est pas compris.
- Consultez toujours un spécialiste en produits de protection du bois !
- Nous vous recommandons de traiter toutes les pièces en bois avec un produit anti pourriture bleue avant le montage.
- Enduire le cadre de base avec un produit de protection du bois avant le montage !
- **Une fois terminé, appliquez sur tout le pavillon plusieurs couches protectrices (au moins deux) de vernis à pores ouverts.**
- Un traitement régulier conformément aux indications du fabricant du vernis protecteur est indispensable pour protéger le bois.
- Débarrasser le toit de la neige en cas de chute de neige prolongée !

CLAUSES DE GARANTIE

weka Holzbau GmbH accorde une garantie de 5 ans sur la construction et la qualité de fabrication. Au cours de la période de garantie, les pièces défectueuses sont remplacées gratuitement. Les coûts liés au remplacement ne sont pas couverts par la garantie.

L'original de la liste des pièces et l'original du justificatif d'achat sont nécessaires pour faire valoir tous droits relatifs à la garantie.

La garantie ne couvre pas les vices dus à:

- des fondations et soubassements non conformes
- un montage non conforme aux présentes instructions
- des charges dues à la neige supérieures à 0,75 kN/m²
- des modifications du produit
- un manque d'entretien en vue du maintien de la qualité du bois
- la prédominance de vents d'une force supérieure à 7 (grand frais)

A l'intérieur des terres, tenir compte à ce sujet par ex. du fait que les arbres entiers bougent ou qu'il est difficile de se déplacer à l'extérieur. Aucun recours au titre de la garantie ne peut être accepté pour les vices consécutifs à ces situations.

- des catastrophes naturelles ou à l'emploi de la force.

Les changements de couleur, la formation de fissures, la déformation ou les autres modifications de ce type sont normaux pour le bois à l'extérieur et ne constituent pas des motifs de réclamation.

Les autres droits et dommages secondaires n'entrent pas dans le cadre des clauses de garantie. En application de nos conditions générales de vente.

OUTIL

Pour le montage, nous vous recommandons de préparer les outils suivants.

N'est pas compris dans la fourniture !

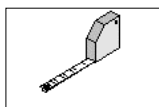

Décamètre à ruban

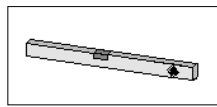

Niveau à bulle

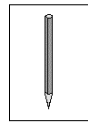

Crayon

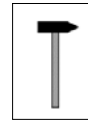

marteau

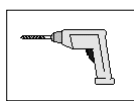

Perceuse



visseuse électrique

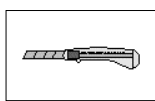

couteau universel

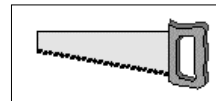

Scie à denture fine

ABRÉVIATIONS

- **F** = fenêtre
- **W** = Pare-vent
- **T** = porte



**Egregi clienti,
ci congratuliamo con voi per avere scelto un prodotto weka.**

- Prima del montaggio leggete con cura le presenti istruzioni al fine di evitare errori di montaggio o danni.
- **IMPORTANTE !**
Controllate subito con l'ausilio della lista di imballaggio che il prodotto weka sia stato fornito completo e senza danni.
- Vi preghiamo di conservare la lista di imballaggio solo alla scadenza del periodo di garanzia. Questa lista serve per controllare la completezza della fornitura e deve essere conservata insieme allo scontrino. Con l'ausilio della lista è possibile risolvere eventuali reclami. I numeri di posizione della lista di imballaggio non corrispondono con i numeri di posizione delle seguenti istruzioni di montaggio.
- Raccomandiamo di eseguire il montaggio in 3 persone.
- Per scongiurare eventuali incidenti tenere lontano i bambini dal luogo di montaggio.
- Ci riserviamo di apportare modifiche ai fini del progresso tecnologico. Per tale motivo è possibile che nelle rappresentazioni vengano a crearsi lievi differenze.
- Non gettare via il materiale di imballaggio! La carta, il cartone normale e ondulato cosiccome gli imballaggi in plastica devono essere smaltiti negli appositi contenitori di raccolta.

RACCOMANDAZIONI

- Per evitare danni agli elementi in legno si raccomanda di preforare tutti i punti di avvitaggio a vite! Il presente simbolo richiama la vostra attenzione su tale particolare nel corso delle istruzioni:



- Proteggete il legno non trattato o naturale prima e durante il montaggio dai raggi solari diretti o dall'umidità!
- Il legno è un prodotto naturale. Differenti irregolarità cromatiche, la ramificazione e la crepatura sono da considerarsi normali e non hanno alcuna influenza sulla statica.
- Condizione necessaria per un corretto assemblaggio, è la presenza di un basamento perfettamente piatto. Pertanto, consigliamo l'impiego di un'unica piastra.
- Per un corretto montaggio è necessario che le fondamenta siano assolutamente piane. Raccomandiamo l'uso di un fondamento a piastre.
- Per evitare danni in caso di tempesta o forte vento il padiglione deve essere ancorato alle fondamenta. Il materiale di fissaggio non è contenuto nella fornitura.
- Di norma, andrebbe consultato un esperto di vernici per il legno!
- Prima dell'assemblaggio, vi consigliamo di trattare tutte le parti componenti in legno con uno strato isolante.
- Prima dell'assemblaggio, è necessario dipingere l'intelaiatura di base con una vernice protettiva per legno!
- **Al termine dell'assemblaggio, date all'intero padiglione diverse mani di vernice protettiva (almeno due); impiegate una velatura che consenta la traspirazione del legno.**
- Per proteggere il legno, è necessaria una regolare verniciatura, in conformità alle direttive della casa produttrice.

In caso di lunghe nevicate, è necessario rimuovere la neve dal tetto!

Condizioni di garanzia

La weka Holzbau GmbH vi offre una garanzia di 5 anni sugli elementi costruttivi e sulla qualità di lavorazione. Durante il periodo di garanzia i componenti difettosi vengono sostituiti gratuitamente. La garanzia non comprende i costi causati dalla sostituzione di componenti difettosi.

La garanzia può essere applicata solamente se accompagnata dalla lista di imballaggio e dallo scontrino di acquisto originali.

La garanzia non copre difetti causati da:

- fondamenta e fondi non appropriati
- un montaggio non eseguito come specificato nelle presenti istruzioni
- carichi di neve maggiori di 0,75 kN/m²
- modifiche al prodotto apportate di propria iniziativa
- manutenzione errata del legno
- presenza costante di venti maggiori di forza 7
nell'entroterra sono visibili effetti quali l'oscillazione di interi alberi e palesi difficoltà nel cammino all'aperto. il produttore non risponde nel caso di danni derivanti da tali cause.
- catastrofi naturali o altri fattori di intervento violento.

Per modifiche cromatiche, formazione di crepe, distorsioni o simili cambiamenti, normali per legni all'aperto, non vi è motivo di reclamo.

La garanzia non copre ulteriori rivendicazioni e danni derivati. Valgono le nostre condizioni generali di vendita.

UTENSILE

Prima di iniziare con il montaggio tenere a portata di mano i seguenti utensili.

Non compreso nella fornitura!

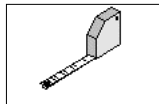

metro a nastro

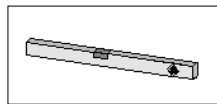

livella ad acqua

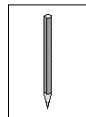

Matita

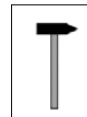

martello

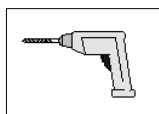

trapano

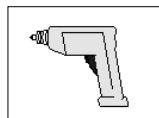

avvitatore elettrico

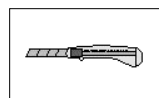

coltello universale

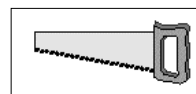

sega fine

ABBREVIAZIONI

- **F** = finestra
- **W** = Paravento
- **T** = porta

E

Apreciado cliente:

Gracias por haber elegido un producto weka.

- Lea de principio a fin estas instrucciones de montaje con el objeto de evitar errores o desperfectos.
- **¡IMPORTANTE!**
Compruebe con la lista de embalaje si el producto weka ha llegado a sus manos completo e intacto.
- No elimine la lista de embalaje antes de expirar el periodo de garantía. La lista sirve para controlar la integridad de las piezas y ha de guardarse junto con el comprobante de compra. Esta lista permite atender con éxito cualquier reclamación que pudiera surgir. Los números de artículo que figuran en la lista de embalaje no coinciden con los números especificados en las siguientes instrucciones de montaje.
- Le aconsejamos realizar el montaje con 3 personas.
- Para evitar accidentes, evite la presencia de niños en la cercanía inmediata durante el montaje.
- Nos reservamos el derecho a realizar modificaciones acordes con el progreso técnico. De ahí pueden surgir ligeras discrepancias en los dibujos y diagramas.
- ¡No tire el material de embalaje! Las envolturas de papel, cartón simple y cartón corrugado así como los elementos de embalaje de materia plástica han de llevarse a los contenedores respectivos.

RECOMENDACIONES

- ¡Por favor, haga previamente las perforaciones para todas las uniones atornilladas a fin de evitar daños en los elementos de madera! El siguiente pictograma le recordará esta indicación durante el montaje:



- ¡Proteja la madera no tratada de la irradiación solar directa y de la humedad antes y durante el montaje!
- La madera es un producto natural. Los diferentes matices, nudos y fisuras son fenómenos normales que no afectan para nada la estética.
- La condición previa para un correcto montaje es un fundamento completamente liso. Recomendamos un fundamento de paneles.
- El requisito necesario para el montaje apropiado son unos cimientos absolutamente planos. Es preferible la cimentación sobre losas.
- Para evitar daños por acción del viento conviene anclar bien el pabellón en los cimientos. El material para el anclaje no forma parte del volumen de suministro.
- ¡Consultar como norma general a un experto de barnices para maderas!
- Recomendamos antes del montaje tratar todos los componentes de madera con imprimación contra el hongo de azuleo.
- ¡Antes del montaje, pintar el bastidor base con un protector de maderas!
- Una vez terminado, pintar todo el pabellón con varias manos (como mínimo dos) de barniz de poros abiertos para maderas.
- Para la protección de la madera es necesario pintarla periódicamente conforme a los datos del fabricante de la laca para maderas.

¡En el caso de nevadas persistentes, retirar la nieve del tejado!

GARANTÍA

La empresa weka Holzbau GmbH le concede una garantía de 5 años sobre la estructura y la calidad del procesamiento. Nos comprometemos a sustituir gratuitamente los elementos defectuosos durante el periodo de garantía. Los costes que ocasione el reemplazo de los elementos no están incluidos en la garantía.

Las pretensiones emanadas de la garantía serán aceptadas sólo en conexión con la lista de embalaje original y el comprobante original de compra.

La garantía excluye desperfectos originados por:

- fundamentos y cimentaciones mal hechos
- un montaje no acorde con las presentes instrucciones
- cargas superiores a 0,75 kN/m² debidas a la nieve
- modificaciones del producto debidas al usuario
- cuidados inadecuados para preservar la calidad de la madera
- la presencia de vientos de fuerza 7 o más (vientos frescos)

Tierra adentro, los efectos se manifiestan en la agitación de árboles enteros y en una resistencia apreciable para andar a la intemperie. Los desperfectos que pudieran ocurrir debido a esas condiciones climáticas excluyen toda garantía por parte nuestra.

- Desastres naturales o efectos cuasi-catastróficos.

No se aceptarán reclamaciones por cambios de matices, agrietamientos, desviaciones o alteraciones similares que son normales en la madera.

Las cláusulas de garantía no incluyen otras pretensiones o daños inherentes. Rigen nuestras condiciones generales de negocio.

HERRAMIENTA

Antes de emprender el montaje hay que tener a mano las siguientes herramientas.

¡No figura en el suministro!

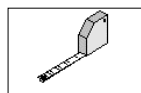

Cinta métrica

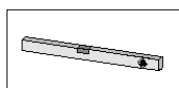

Nivel de burbuja



Lápiz



Martillo

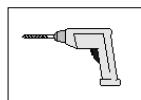

Taladradora eléctrica

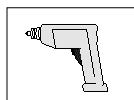

Destornillador eléctrico

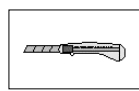

Cuchilla universal

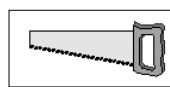

Sierra fina

ABREVIATURAS

- **F** = ventana
- **W** = Paraviento
- **T** = puerta

P

Estimada(o) Cliente, Parabéns por ter escolhido um produto weka!

- Antes de proceder à montagem, leia o presente manual de instruções na íntegra, por forma a evitar erros de montagem ou danos.
- **IMPORTANTE !**
Com base na lista da embalagem, verifique de imediato se o produto weka está completo e se não apresenta danos.
- Conserve a lista da embalagem até o período de garantia expirar. Esta lista serve para verificar se as peças se encontram completas e deverá ser guardada juntamente com o comprovativo da compra. Esta lista permite ainda a resolução imediata de eventuais reclamações. As posições da lista da embalagem não coincidem com as posições das seguintes instruções de montagem.
- Recomendamos que a montagem seja efectuada por 3 pessoas.
- Com vista à prevenção de acidentes, há que evitar a presença de crianças nas proximidades do local de montagem.
- Reservamo-nos o direito a alterações decorrentes de avanços tecnológicos, na sequência dos quais os desenhos poderão apresentar diferenças não muito significativas.
- Não descarte o material de embalagem de qualquer maneira! As embalagens de papel, cartão e cartão ondulado, bem como partes da embalagem em plástico deverão ser colocadas nos respectivos recipientes colectores.

RECOMENDAÇÕES

- Fure previamente todas as uniões roscadas por forma a evitar danos nas peças de madeira! Ao longo do presente manual de instruções, o seguinte símbolo chamará a sua atenção para esta necessidade:



- Antes e durante os trabalhos de montagem deverá proteger a madeira não tratada da exposição directa ao sol e à humidade!
- A madeira é um produto natural. As diferentes colorações, os nós e a formação de fendas são normais e não exercem qualquer influência sobre a estabilidade.
- Para uma montagem perfeita, é imprescindível que a fundação esteja bem nivelada. Recomendamos uma fundação de placa.
- Para proteger o pavilhão contra danos causados pelo vento, o pavilhão deve ser ancorado à fundação. O material de fixação não está incluído fornecimento.
- Para prevenir a humidade ascendente, recomendamos a colocação de uma camada isoladora de película da embalagem, do papelão de cobertura, etc. entre a base e o barrote do soalho. A camada isoladora em papelão de cobertura não faz parte do volume de fornecimento.
- Por norma, deverá consultar um especialista em produtos para aplicação em madeiras!
- Antes da montagem, recomendamos que trate todos os módulos em madeira com primário inibidor de azulado.
- Antes da montagem, aplique um produto de preservação de madeiras no caixilho de base!
- Depois de terminar, aplique algumas demãos de protecção (pelo menos duas), de um verniz de madeiras para poros abertos em todo o pavilhão.
- É necessário aplicar uma demão regularmente, de acordo com os dados do fabricante de verniz de preservação de madeiras.
- Se nevar muito, limpe a neve do telhado!

CONDIÇÕES DE GARANTIA

A Empresa weka Holzbau GmbH garante-lhe 5 anos de garantia sobre a qualidade da construção e do processamento. Durante o período de garantia, as peças com defeito serão substituídas gratuitamente. Os custos inerentes às substituições não são cobertos pela garantia.

A garantia poderá apenas ser concedida mediante a apresentação da lista da embalagem original e do comprovativo original de compra.

A garantia exclui falhas condicionadas por:

- fundações e bases inadequadas
- montagem não efectuada de acordo com as nossas instruções de montagem
- sobrecargas de neve acima de 0,75 kN/m²
- alterações voluntariamente implementadas no produto
- tratamento deficiente com vista à manutenção da qualidade da madeira
- a predominância de ventos com velocidades acima da intensidade 7 (vento forte)

No interior do país é possível verificar consequências como a movimentação de árvores e entaves perceptíveis à locomoção ao ar livre. Não é concedida garantia em caso de falhas derivadas destas condições.

- Catástrofes naturais ou qualquer outro tipo de motivos de força maior.

Em caso de alterações da cor, formação de fendas, deformações ou alterações similares, normais em madeiras expostas ao ar livre, não existe qualquer fundamento para reclamar a garantia.

A garantia não cobre quaisquer outras reivindicações e danos subsequentes. Vigoram as nossas condições gerais de venda.

FERRAMENTA

Antes de dar início à montagem, deverá ter à mão as seguintes ferramentas.

Não faz parte do material a fornecer!

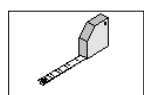

Fita métrica com

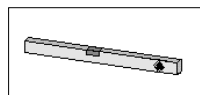

Nível de bolha de ar



Lápis



Martelo

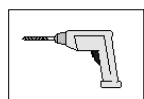

Berbequim



Aparafusadora

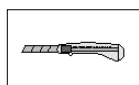

Lâmina universal

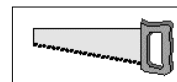

Serra fina

ABREVIATURAS

- **F** = Janela
- **W** = Protecção contra o vento
- **T** = Porta

H

Kedves ügyfelünk!

- A szerelési hibák vagy meghibásodások elkerülése érdekében felépítés előtt olvassa el végig ezt az útmutatót.
- **FONTOS!**
A csomagolási jegyzék alapján azonnal ellenőrizze, hogy a termék hiánytalanul és sérülésmentesen érkezett-e meg Önhöz.
- A csomagolási jegyzéket csak a garanciális idő letelte után semmisítse meg. Ez a jegyzék az egyes elemek teljességének ellenőrzésére szolgál, és a vásárlási számlával együtt meg kell őrizni. Az esetleges reklamációk ennek a jegyzéknek a segítségével problémamentesen elintézhetőek. A csomagolási jegyzék egyes tételszámai nem egyeznek meg az alábbi szerelési utasítás tételszámaival.
- Azt javasoljuk, hogy 3 személy végezze a szerelést.
- A balesetek megelőzése érdekében kerülni kell azt, hogy gyermekek tartózkodjanak a szerelés közvetlen közelében.
- A műszaki haladás érdekében végzett továbbfejlesztések jogát fenntartjuk. Így az ábrázolásban kisebb eltérések keletkezhetnek.
- Ne dobja el egyszerűen a csomagolóanyagot! A papír-, karton, és hullámpapír-csomagolásokat, valamint a csomagolás műanyag elemeit a megfelelő gyűjtőtartályba kell rakni.

JAVASLATOK

- A faelemek sérülésének elkerülése érdekében fúrjon elő minden csavaros kötést! Az útmutatóban a következő jel még egyszer figyelmezteti Önt erre.



- A felépítés előtt és alatt védje a fát az órákon át tartó közvetlen napsütéstől vagy nedvességtől.
- A fa természetes anyag. A különböző elszíneződések, ágcsomók és repedések normálisnak tekintendők, és semmilyen hatásuk nincs a statikára.
- A szakszerű szerelés előfeltétele az abszolút sík alap. Javasoljuk lemezalap készítését.
- A szél okozta sérülések megakadályozására pavilont le kell horgonyozni az alapra. Erre a célra megfelelő a szaktereskedelemben kapható betonhorgony vagy szögvas, amivel az alapkeret az alapra rögzíthető. A horgonyok nem tartoznak a szállítási terjedelemhez.
- A felszálló nedvesség elkerüléséhez javasoljuk, hogy az alap és az alapkeret közé helyezzen tetőfedő lemezből vagy más anyagból készült záróréteget. A tetőfedő lemezből készült záróréteg nem tartozik a szállítási terjedelemhez.
- Mindenképpen konzultáljon egy, fafestékekkel foglalkozó szakemberrel!
- Javasoljuk, hogy szerelés előtt minden faelemet kezeljen le kékgomba elleni alapozóval.
- Szerelés előtt kenje le az alapkeret favédőszerral.
- **Készre szerelés után kenje le az egész pavilont többször is (legalább kétszer) nyitott pórusú favédő lazúrfestékkel.**
- A favédő lazúrfesték gyártója szerinti rendszeres átfestésre a fa védelme érdekében van szükség.
- Hosszantartó hóeséskor tisztítsa le a havat a tetőről!

Garanciális rendelkezések

A weka-Holzbau GmbH cég 5 év garanciát vállal mind a konstrukcióra, mind pedig a megmunkálás minőségére. A garanciális időn belül az esetleges hibás alkatrészeket térítésmentesen kicseréljük. A csere miatt keletkező költségek nem tartoznak bele a garanciaigénybe.

Garanciaigények csak az eredeti csomagolási jegyzékkel és az eredeti vásárlási bizonylattal együtt érvényesíthetők.

Nem vállalunk garanciát olyan hibákért, amelyek az alábbi okokra vezethetők vissza:

- szakszerűtlen alapok és alapozások
- nem a mi építési utasításunk szerint elvégzett szerelés
- nagyobb hőterhelés
- önkényes változtatások a terméken
- a fa vásárláskor meglévő minőségének fenntartásához szükséges ápolás hiányos, illetve hibás elvégzése
- a 7-es erősségű szél okozta szélesebségek túlsúlya (erős szél)
 - Ilyenkor olyan hatások figyelhetők meg, hogy például a fák teljes egészükben mozognak, és a szél érezhetően gátolja a szabadban való mozgást. Az ilyen körülmények között bekövetkezett hibákért nem vállalunk garanciát.
- természeti katasztrófák vagy más jellegű erőszakos hatások.

A szabadban lévő faanyagoknál teljesen megszokott színváltozásokért, repedések képződéséért, deformálódásért vagy hasonló változásokért nem fogadunk el reklamációt.

A fentiekén túlmenő igények és a következményes károk nem esnek a garanciális rendelkezések hatálya alá. Általános üzleti feltételeink érvényesek.

SZERSZÁM

A szerelés megkezdése előtt a következő szerszámokat helyezze készenlétbe:

(Nincsenek a szállítási terjedelemben!)

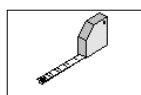

mérőszalag

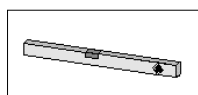

vízmérték



ceruza

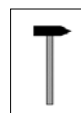

kalapács

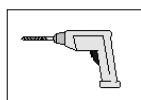

fúrógép



elektromos csavarozó

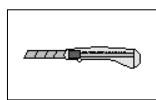

univerzális kés

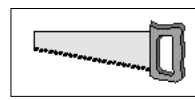

fűrész

Rövidítések

- F = ablak
- W = szélvédő
- T = ajtó



Geachte klant,

- Lees deze handleiding vóór de montage helemaal om montagefouten of beschadigingen te vermijden.
- **BELANGRIJK!**
Controleer direct aan de hand van de paklijst of het product van weka volledig en onbeschadigd bij u is aangekomen.
- Vernietig de paklijst pas na afloop van de garantieperiode. Deze lijst is voor de controle op volledigheid van alle onderdelen en moet met de kassabon worden bewaard. Eventuele reclames kunnen met behulp van deze lijst probleemloos worden opgelost. De pos.-nummers van de paklijst komen niet overeen met de pos.-nummers van de volgende montagehandleiding.
- Wij adviseren de montage met 3 personen uit te voeren.
- Om ongevallen te voorkomen, moet worden vermeden dat kinderen zich tijdens de montage in de directe nabijheid bevinden.
- Ontwikkelingen in de zin van technische vooruitgang behouden wij ons voor. Op deze wijze kunnen kleine afwijkingen in de afbeeldingen ontstaan.
- Verpakkingsmateriaal niet zomaar weggooien! Verpakking van papier, karton, golfkarton en kunststof moet in de betreffende verzamelcontainer worden gedeponerd.

Advies

- Boor alle schroefverbindingen voor om beschadiging van de houten delen te voorkomen. Het volgende symbool maakt u in de handleiding nogmaals hierop opmerkzaam:



- Bescherm het hout tegen urenlang, direct zonlicht of vocht.
- Hout is een natuurproduct. Verschillende kleurschakeringen, knoesten en scheurvorming zijn normaal en hebben geen invloed op de stevigheid
- Om het huis vakkundig te kunnen monteren dient er eerst een volledig vlakke fundering te worden aangebracht. Wij adviseren een platenfundering.
- Ter voorkoming van windschade dient het huis met de fundering te worden verankerd. Geschikt hiervoor zijn bij de speciaalzaak verkrijgbare betonankers of stalen hoeken waarmee de vloerbalken op de fundering worden bevestigd. De verankeringsmiddelen zijn niet inbegrepen in de levering.
- Ter voorkoming van opstijgend vocht adviseren wij om tussen de fundering en de vloerbalken een isolatielaag aan te brengen van de verpakkingsfolie, asfaltpapier o.i.d. Een isolatielaag van asfaltpapier is niet inbegrepen in de levering.
- Raadpleeg altijd een vakman voor houtlak!
- Wij adviseren u om alle houten onderdelen voor de montage te behandelen met een impregneer- en grondlak.
- Het basiskader moet voor de montage worden gelakt met een houtbeschermend middel!
- **Is het paviljoen opgebouwd, breng dan aan de buitenkant van het hele paviljoen meerdere lagen aan (minstens twee) van een poreuze lazuurverf.**
- Om het hout blijvend te beschermen dient de lazuurverf regelmatig aangebracht te worden volgens de gegevens van de fabrikant.
- Bij langdurige sneeuwval moet het dak sneeuwvrij worden gemaakt!

Garantie bepalingen

De firma weka Holzbau GmbH geeft u 5 jaar garantie op constructie en verwerkingskwaliteit. Binnen de garantieperiode worden onderdelen met gebreken gratis vervangen. De kosten van vervanging behoren niet tot de garantie.

Aanspraak op garantie kan uitsluitend in combinatie met de originele paklijst en de originele kassabon worden behandeld.

Uitgesloten van garantie zijn gebreken die veroorzaakt zijn door:

- verkeerde funderingen
- montage die niet volgens deze handleiding is uitgevoerd
- sneeuwbelasting
- eigen veranderingen aan het product
- verkeerde behandeling voor conservering van het hout
- windsnelheden hoger dan windkracht 7 (harde wind)
 - In het binnenland is dit o.a. te merken aan bomen die in hun geheel bewegen en aan een voelbare weerstand bij het buiten lopen. Gebreken die door deze omstandigheden ontstaan, vallen niet onder de garantie.
- natuurrampen of gebruik van geweld

Kleurveranderingen, scheurvorming, vervorming of soortgelijke veranderingen die normaal zijn bij hout in de buitenlucht, zijn geen reden voor reclames.

Verderstreckende aanspraak en gevolgschade vallen niet onder de garantie. Van toepassing zijn onze algemene voorwaarden.

Gereedschap

Het volgende gereedschap moet u vóór het begin van de montage gereed hebben liggen:
(is niet inbegrepen in de levering)

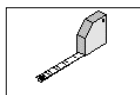

meetlint

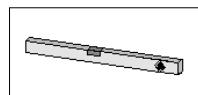

waterpas



potlood

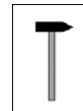

hamer

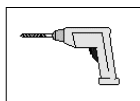

boormachine



fittingschroevendraaier

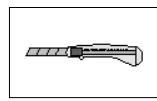

afbreekmes

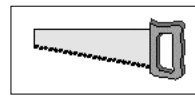

zaag

Afkortingen

- **F** = Raam
- **W** = Windscherm
- **T** = Deur



Štovani kupci,

- Prije postavljanja pročitajte kompletno ovo uputstvo, kako bi spriječili greške ili oštećenja prilikom montaže.
- **VAŽNO !**
Molimo provjerite smjesta na osnovu popisa dijelova da li je proizvod stigao do Vas kompletan i neoštećen.
- Molimo da bacite popis pakovanja tek nakon što istekne garancija. Taj popis služi kao kontrola kompletnosti pojedinih dijelova i treba ga sačuvati zajeno s potvrdom o kupnji. Eventualne reklamacije se pomoću tog popisa mogu bez problema riješiti. Brojevi pozicija popisa pakovanja ne odgovaraju brojevima pozicija narednih uputstava za montažu.
- Preporučujemo da montažu provedete s 3 osobe.
- Da bi spriječili nesreće nemojte dozvoliti da se za vrijeme montaže u neposrednoj blizini nalaze djeca.
- Dozvoljavamo si pravo na daljnji razvoj u smislu tehničkog napretka. Tako može doći do neznatnih odstupanja od slikovitih prikaza.
- Nemojte jednostavno baciti ambalažu! Ambalažu od papira, kartona i valovitog kartona, kao i dijelove od plastične mase treba staviti u odgovarajuće kontejnere za sakupljanje.

Preporuke

- Molimo da sve vijčane spojeve prethodno izbušite kako biste spriječili oštećenja na drvenim dijelovima! Slijedeći znak Vas još jednom tokom uputstava na to upozorava:



- Zaštite drvo od direktnog višesatnog djelovanja sunca i od vlage.
- Drvo je proizvod prirode. Razna obojenja, čvorovi i stvaranje pukotina su normalni i ne utiču na statiku.
- Uvjet za stručnu montažu je apsolutno ravni temelj. Preporučujemo Vam temelj u pločama.
- Paviljon treba protiv oštećenja usljed vjetra usidriti na temelj. Kuću treba usidriti na temelj protiv oštećenja usljed vjetra. Za to su pogodna betonska sidra ili čelični profili iz specijaliziranih prodavonica, pomoću kojih se podne grede pričvršćuju na temelj. Sredstva za usidrenje ne spadaju u obim isporuke.
- Kako bi spriječili nadolaženje vlage, preporučujemo da između temelja i podnih greda stavite sloj za blokadu od folije za ambalažu, krovni bitumenski karton ili slično. Sloj za blokadu od krovnog bitumenskog kartona nije sadržan u obimu isporuke.
- U načelu bi se trebali posavjetovati sa stručnjakom za premaze drva!
- Preporučujemo da sve drvene dijelove obradite prije montaže pomoću sredstva za temeljnu zaštitu.
- Osnovne okvire treba prije montaže premazati zaštitnim sredstvom za drvo!
- **Nakon postavljanja premažite nekoliko puta cijeli paviljon radi zaštite (najm. 2 premaza) sa zaštinom lazurnom za drvo za otvorene pore.**
- U svrhu zaštite drveta je potreban redoviti premaz prema podacima proizvođača lazurne zaštitne sredstva.
- Kod snježnih nanosa koji se dugo zadržavaju treba osloboditi krov od snijega!

Odredbe garancije

Firma weka Holzbau GmbH Vam daje 5 godina garancije na konstrukciju i kvalitetu obrade. Unutar perioda garancije se neispravni dijelovi besplatno zamjenjuju. Troškovi koji nastanu usljed zamjene nisu obuhvaćeni u zahtjevima garancije.

Pravo na garanciju se može ostvariti samo u vezi s originalnim popisom pakovanja i originalnim kupovnim računom.

Prije garancije su isključeni nedostaci koji su uvjetovani usljed:

- nestručnih temelja i potporišta
- montaže koja nije provedena prema ovom uputstvu
- opterećenja usljed snijega
- vlastitih izmjena na proizvodu
- neispravne njege za sačuvanje postojeće kvalitete drveta
- brzine vjetrova pretežno iznad 7 bofora (snažni vjetar)
 - U unutrašnjosti zemlje se to očituje kao npr. gibanje čitavih stabala i osjetna smetnja prilikom hodanja na otvorenom. Ako dođe do neodstatata uzrokovanih takvim uslovima ne preuzima se nikakva garancija.
- Prirodne katastrofe i drugo nasilno djelovanje.

U slučaju izmjene boje, stvaranja pukotina, deformacija i sličnih promjena, koje su normalne kod drva na otvorenom, ne postoji razlog za reklamaciju.

Daljnji zahtijevi i štete kao posljedica ne spadaju pod odredbe o garanciji. Vrijede naši općii uslovi o poslovanju.

alat

Slijedeći alat bi trebali pripremiti prije početka montaže.

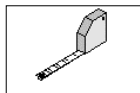

mjerna traka

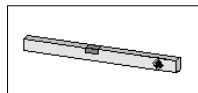

Libela



olovka

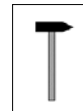

čekić

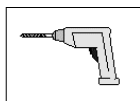

bušilica



elektro-odvijač

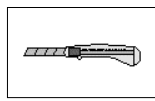

univerzalni nož

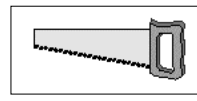

pila

Skraćenice

- F = prozor
- W = vjetrobran
- T = vrata

Spoštovani kupec,

- Preden začnete z gradnjo, natančno preberite to navodilo, da se boste tako lahko izognili napakam pri montaži ali poškodbam.
- **POZOR!**
S pomočjo ovojnega lista takoj preverite, če se prejeli weka izdelek nepoškodovan in v celoti.
- Ovojni list uničite šele po poteku garancijske dobe. Ta list vam bo služil za kontrolo popolnosti posameznih delov in hraniti ga morate skupaj z računom. Morebitne napake se lahko s pomočjo tega lista brez problemov odpravijo. Pozicijske številke ovojnega lista se ne ujemajo s pozicijskimi številkami naslednjega navodila za montažo.
- Priporočamo vam, da montažo izvedete z dvema osebama.
- Da bi preprečili morebitne nesreče, se otroci v času montaže naj ne nahajajo v neposredni bližini.
- V smislu tehničnega napredka si pridružujemo pravico do nadaljnjega razvoja. Tako lahko v prikazih pride do majhnih odstopanj.
- Ovojnega materiala ne odvrzite kar tako! Papirnato embalažo, embalažo iz lepenke in valovite lepenke, kakor tudi embalažne dele iz plastike odvrzite v ustrezne zbiralne posode.

Priporočilo

- Da bi se izognili poškodbam na lesenih delih, navrtajte navojne spoje! Sledeči znak vas med navodilom na to opozori še enkrat:



- Les zaščitite pred daljšimi, direktnim vplivi sonca ali vlage.
- Les je naravni izdelek. Različna obarvanja, veje in nastajanje razpok so normalni pojavi in nimajo vpliva na statiko.
- Pogoji za strokovno montažo je povsem raven temelj. Priporočamo Vam temelj iz plošč.
- Paviljon je potrebno pred škodo vetra pritrditi s temeljem. V ta namen so primerna betonska sidra ali jekleni kotniki, ki jih je mogoče dobiti v specializirani trgovini. Z njimi pritrdite talne tramove na temelj. Zasadranje ne spada v obseg dobave.
- Da bi preprečili dviganje vlago, vam priporočamo, da med temelj in talni tram položite zaporno plast iz ovojnega folije, strešne lepenke ipd. Zaporna plast iz strešne lepenke ni zajeta v obsegu dobave.
- Načeloma bi bilo dobro, da se posvetujete s strokovnjakom za lesna premazna sredstva!
- Priporočamo vam, da pred montažo vse lesene gradbene dele premažete z modro osnovo.
- Osnovni okvir pred montažo premažite z zaščitnim premazom za les!
- **Po postavitvi celoten paviljon večkrat premažite z zaščitnim premazom (vsaj 2 premaza) porozne lazure za zaščito lesa.**
- Redni premaz v skladu s podatki proizvajalca za lazuro za zaščito lesa je za zaščito hiše potreben.
- Pri dolgotrajnem sneženju s strehe očistite sneg!

Garancijska določila

Podjetje weka Holzbau d.o.o. vam zagotavlja petletno garancijo na konstrukcijo in kvaliteto obdelave. V času garancije se poškodovani deli nadomestijo brezplačno. Stroški, ki nastanejo z zamenjavo, ne spadajo pod garancijo.

Pravice iz garancije se lahko terjajo le v povezavi z originalnim ovojnim listom in računom.

Pod garancijo ne spadajo napake, ki so pogojene z:

- nepravilnimi temelji in temeljenjem
- montažo, ki ni izpeljana v skladu s tem navodilom
- snežnimi obremenitvami
- lastnimi spremembami na izdelku
- pomanjkljivim vzdrževanjem za ohranitev obstoječe kvalitete lesa
- prevladovanjem hitrosti vetra preko moč vetra 7 (močan veter)
 - V notranjosti je pri tem potrebno upoštevati učinkovanje kot npr. gibanje celih dreves in občutno oviranje pri hoji na prostem. Pri povzročitvi poškodb na osnovi teh pogojev garancija ne velja.
- naravnimi nesrečami ali drugimi nasilnimi delovanji.

Pri barvnih spremembah, nastajanju razpok, izkrivljanju ali podobnih spremembah, ki so pri lesu na prostem normalni pojav, ni vzroka za reklamacijo.

Nadaljnje pravice in posledične škode ne spadajo v garancijska določila. Veljajo naši splošni poslovni pogoji.

Orodje

Pred začetkom montaže si pripravite sledeče orodje.

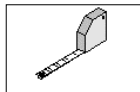

šiviljska mera

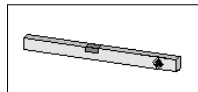

Vodna tehtnica



Svinčnik

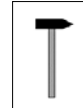

kladivo

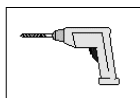

vrtalni stroj



električni vijačnik

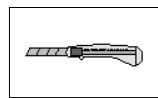

univerzalni nož

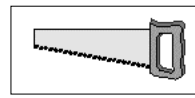







žaga

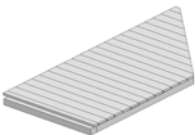



Okrajšave

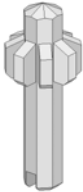



- **F** = okno
- **W** = vetrobran
- **T** = vrata

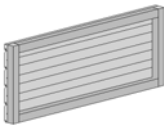

D Stückliste			
GB	Parts list	H	darabjegyzék
F	liste des pièces	NL	onderdelenlijst
I	lista pezzi	HR	popis dijelova
E	Lista de piezas	SLO	lista kosov
P	Lista de peças		

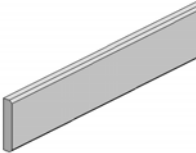

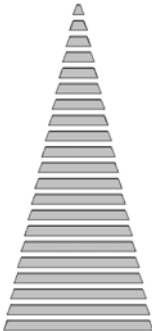

Pos	Bild	Land	Benennung	Abmessung	Stück	
					234.2828.20.00	234.2828.30.00
①		D	Bodenelement	851 x 1958	4	4
		GB	Floor element			
		F	élément de sol			
		I	elemento del pavimento			
		E	Panel del piso			
		P	Elemento do soalho			
		H	padlóelem			
		NL	vloerelement			
		HR	podni element			
		SLO	talni element			
②		D	Bodenelement	1145 x 1145	1	1
		GB	Floor element			
		F	élément de sol			
		I	elemento del pavimento			
		E	Panel del piso			
		P	Elemento do soalho			
		H	padlóelem			
		NL	vloerelement			
		HR	podni element			
		SLO	talni element			
③		D	Pfosten	133 X 2300	8	8
		GB	Stud			
		F	poteau			
		I	montante			
		E	Poste			
		P	Poste			
		H	oszlop			
		NL	post			
		HR	stubovi			
		SLO	steber			

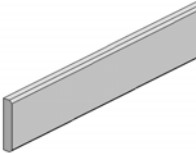
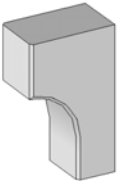
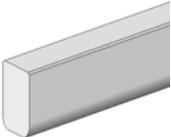

Pos	Bild	Land	Benennung	Abmessung	Stück	
					234.2828.20.00	234.2828.30.00
4		D	Sparren	55/85/1942	8	8
		GB	Rafter			
		F	chevron			
		I	travetto			
		E	Cabrio			
		P	Asna			
		H	szarufa			
		NL	dakspar			
		HR	greda na krovu			
		SLO	škarnik			
5		D	Firstholz	167 x 895	1	1
		GB	Ridge timber			
		F	bois de faîte			
		I	traversa di colmo			
		E	Madera cabalete			
		P	Madeira da cumeeira			
		H	greincfa			
		NL	nokhout			
		HR	drvo sljemena			
		SLO	slemenski les			
6		D	Wandelement W	1020 x 2300	3	-
		GB	Wall element			
		F	élément de paroi			
		I	elemento da parete			
		E	Panel mural			
		P	Elemento de parede			
		H	falelem			
		NL	wandelement			
		HR	zidni element			
		SLO	Stenski element			
7		D	Wandelement Fenster	1020 x 1665	4	7
		GB	Wall element			
		F	élément de paroi			
		I	elemento da parete			
		E	Panel mural			
		P	Elemento de parede			
		H	falelem			
		NL	wandelement			
		HR	zidni element			
		SLO	Stenski element			



Pos	Bild	Land	Benennung	Abmessung	Stück	
					234.2828.20.00	234.2828.30.00
8		D	Wandelement Tür	1020 x 2050	1	1
		GB	Wall element			
		F	élément de paroi			
		I	elemento da parete			
		E	Panel mural			
		P	Elemento de parede			
		H	falelem			
		NL	wandelement			
		HR	zidni element			
		SLO	Stenski element			
9		D	Wandelement OT	1020 x 250	5	8
		GB	Wall element			
		F	élément de paroi			
		I	elemento da parete			
		E	Panel mural			
		P	Elemento de parede			
		H	falelem			
		NL	wandelement			
		HR	zidni element			
		SLO	Stenski element			
10		D	Wandelement UT	1020 x 385	4	7
		GB	Wall element			
		F	élément de paroi			
		I	elemento da parete			
		E	Panel mural			
		P	Elemento de parede			
		H	falelem			
		NL	wandelement			
		HR	zidni element			
		SLO	Stenski element			
11		D	Abdeckleiste	40/40/1105	7	7
		GB	Roof plate			
		F	plaque de couverture			
		I	piastra del tetto			
		E	Paneles de cubierta			
		P	Placa do telhado			
		H	fedólec			
		NL	afdeklijst			
		HR	izolacijska letvica			
		SLO	zaključna letev			

Pos	Bild	Land	Benennung	Abmessung	Stück	
					234.2828.20.00	234.2828.30.00
12		D	Deckleiste	11/58/980	9	15
		GB	Ceiling batten			
		F	latte de recouvrement			
		I	listello di copertura			
		E	Listo tapajuntas			
		P	Cobrejunta			
		H	takaróléc			
		NL	deklíjst			
		HR	stropna letvica			
		SLO	stropna letev			
13		D	Schlagleiste	11/58/1600	4	7
		GB	Impact batten			
		F	battement			
		I	listello di battuta			
		E	Batiente			
		P	Sanefa			
		H	ütközőléc			
		NL	slaglijst			
		HR	udarna letvica			
		SLO	udarna letev			
14		D	Dachschalung		8	8
		GB	Roof boarding			
		F	sous-toiture			
		I	armatura del tetto			
		E	Entarimado de la cubierta			
		P	Prancha do telhado			
		H	tetődeszkázat			
		NL	dakbeschot			
		HR	oplata krova			
		SLO	strešni opaž			
15		D	Deckleiste	15 / 40 / 2260	16	16
		GB	Ceiling batten			
		F	latte de recouvrement			
		I	listello di copertura			
		E	Listo tapajuntas			
		P	Cobrejunta			
		H	takaróléc			
		NL	deklíjst			
		HR	stropna letvica			
		SLO	stropna letev			

Pos	Bild	Land	Benennung	Abmessung	Stück	
					234.2828.20.00	234.2828.30.00
16		D	Deckleiste	11/58/1120	8	8
		GB	Ceiling batten			
		F	latte de recouvrement			
		I	listello di copertura			
		E	Listo tapajuntas			
		P	Cobrejunta			
		H	takaróléc			
		NL	deklíjst			
		HR	stropna letvica			
		SLO	stropna letev			
17		D	Halterung	55/90/150	2	2
		GB	Mounting			
		F	fixation			
		I	supporto			
		E	Soporte			
		P	Suporte			
		H	tartó			
		NL	houder			
		HR	Držač			
		SLO	Držalo			
18		D	Auflager	55/100/3000	1	1
		GB	support			
		F	Appui			
		I	Appoggio			
		E	Listón de asiento			
		P	Apoio			
		H	támasz			
		NL	steun			
		HR	nasjed			
		SLO	naslonska letev			
19		D	Schraube	6,0 x 150	10	10
		GB	Screw			
		F	vis			
		I	vite			
		E	Tornillo			
		P	Parafuso			
		H	csavar			
		NL	schroef			
		HR	vijak			
		SLO	vijak			

Pos	Bild	Land	Benennung	Abmessung	Stück	
					234.2828.20.00	234.2828.30.00
20		D	Schraube	5,0 x 120	10	10
		GB	Screw			
		F	vis			
		I	vite			
		E	Tornillo			
		P	Tábua de beiral			
		H	csavar			
		NL	schroef			
		HR	vijak			
		SLO	vijak			
21		D	Schraube	5,0 x 100	5	5
		GB	Screw			
		F	vis			
		I	vite			
		E	Tornillo			
		P	Parafuso			
		H	csavar			
		NL	schroef			
		HR	vijak			
		SLO	vijak			
22		D	Schraube	5,0 x 80	160	160
		GB	Screw			
		F	vis			
		I	vite			
		E	Tornillo			
		P	Parafuso			
		H	csavar			
		NL	schroef			
		HR	vijak			
		SLO	vijak			
23		D	Schraube	4,0 x 60	40	40
		GB	Screw			
		F	vis			
		I	vite			
		E	Tornillo			
		P	Tábua de beiral			
		H	csavar			
		NL	schroef			
		HR	vijak			
		SLO	vijak			

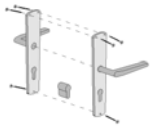
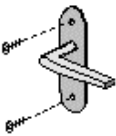
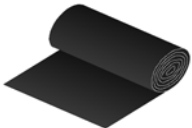
Pos	Bild	Land	Benennung	Abmessung	Stück	
					234.2828.20.00	234.2828.30.00
24		D	Schraube	3,5 x 35	840	840
		GB	Screw			
		F	vis			
		I	vite			
		E	Tornillo			
		P	Tábua de beiral			
		H	csavar			
		NL	schroef			
		HR	vijak			
		SLO	vijak			
25	-			-	-	-
26		D	Dachpappstift	2,0 x 16	800	800
		GB	Tack			
		F	pointe pour carton bitumé			
		I	spina per cartone catramato			
		E	Espiga para cartón asfáltico			
		P	Prego de cabeça larga			
		H	fedéllemez-szeg			
		NL	asfaltnagel			
		HR	čavao za krovni karton			
		SLO	žebelj za strešno lepenko			
27		D	Dachpappstift	2,5 x 25	215	215
		GB	Tack			
		F	pointe pour carton bitumé			
		I	spina per cartone catramato			
		E	Espiga para cartón asfáltico			
		P	Prego de cabeça larga			
		H	fedéllemez-szeg			
		NL	asfaltnagel			
		HR	čavao za krovni karton			
		SLO	žebelj za strešno lepenko			

Pos	Bild	Land	Benennung	Abmessung	Stück	
					234.2828.20.00	234.2828.30.00
28		D	Drückergarnitur		1	1
		GB	Printer's equipment			
		F	garniture de loquet			
		I	completo maniglia			
		E	Juego de impresión			
		P	Ferragens do trinco			
		H	kilincskészlet			
		NL	deurklinken			
		HR	garnitura za pritiskanje			
		SLO	garnitura pritiskačev			
29		D	Fenstergriff		4	7
		GB	Window handle			
		F	poignée de fenêtre			
		I	maniglia della finestra			
		E	Manija de la ventana			
		P	Manípulo da janela			
		H	ablakkilincs			
		NL	raamgreep			
		HR	držka prozora			
		SLO	okenska kljuka			
30		D	Dachpappe		15 m ²	15 m ²
		GB	Roof paper			
		F	carton bitumé			
		I	cartone catramato			
		E	Cartón asfáltico			
		P	Papelão da cobertura			
		D	Dachpappe			
		GB	Roof paper			
		F	carton bitumé			
		I	cartone catramato			
31		D	Messingplakette mit weka-Logo	DM 65mm	1	1
		GB	weka-logo			
		F	weka-logo			
		I	weka-logo			
		E	weka-logotipo			
		P	weka-logotipo			
		H	weka-logoval			
		NL	weka-logo			
		HR	weka-logom			
		SLO	weka-logotipom			

Pos	Bild	Land	Benennung	Abmessung	Stück	
					234.2828.20.00	234.2828.30.00
32		D	Halbrundkopfschraube	2,5 x 16	2	2
		GB	Round head screw			
		F	vis à tête bombée			
		I	vite a testa tonda			
		E	Tornillo de cabeza semiesférica			
		P	Parafuso de cabeça redonda cónica			
		H	félgömbfejű csavar			
		NL	bolkop Schroef			
		HR	Čavao s poluokruglom glavom			
		SLO	polkrožni čelni vijak			

D	Fundamentplatte		
GB	Foundation	H	alaplak
F	plaque de fondation	NL	funderingsplaat
I	plastra di fundamenta	HR	temeljna ploča
E	Losa de cimentación	SLO	plošča temelja
P	Placa de fundação		

1

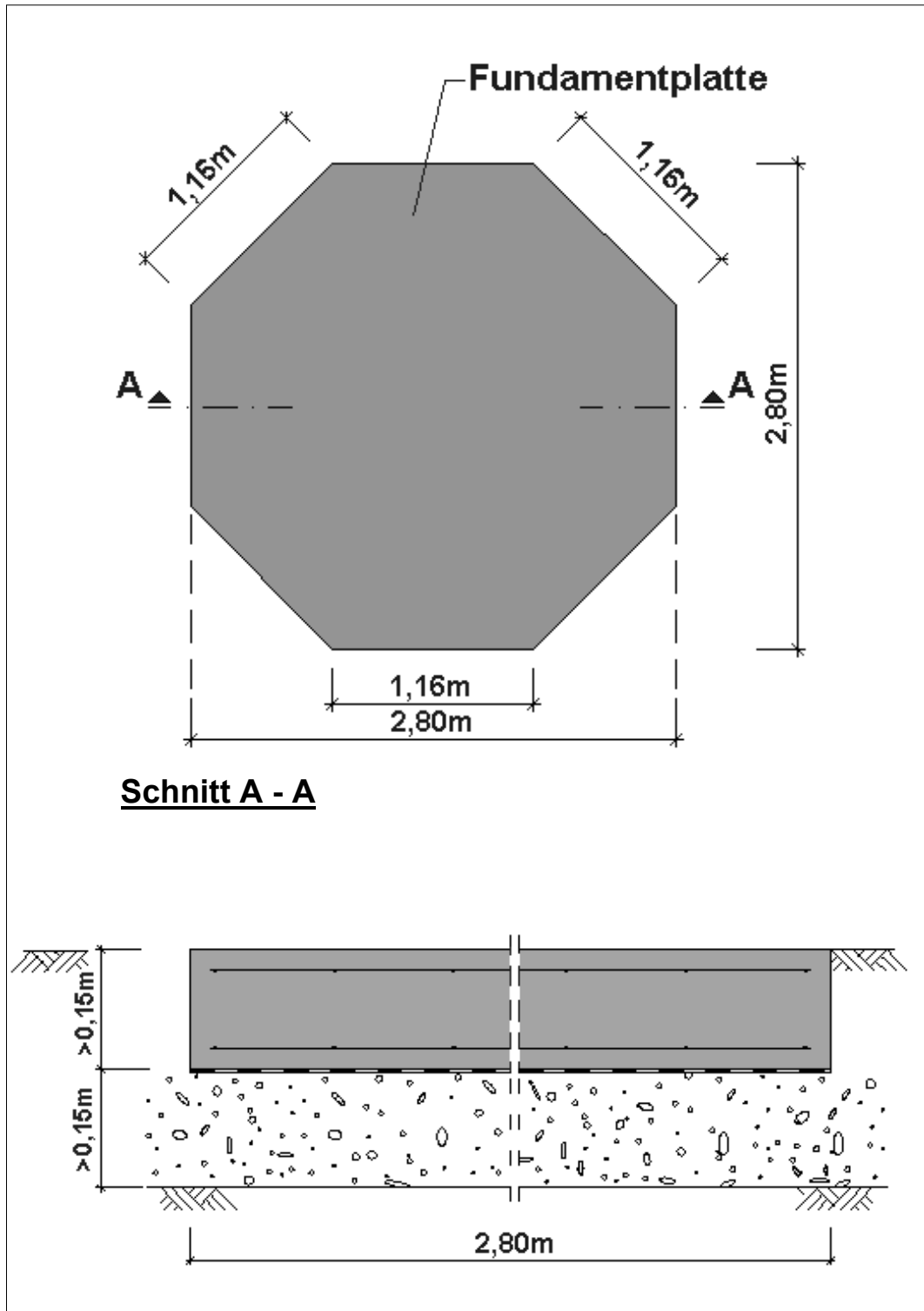

D	Aufbauvarianten		
GB	Foundation	H	felépítési változat
F	plaque de fondation	NL	opbouwvariant
I	plastra di fundamenta	HR	varijanta postavljanja
E	Losa de cimentación	SLO	varianta izgradnje
P	Placa de fundação		

2

234.2828.20.00

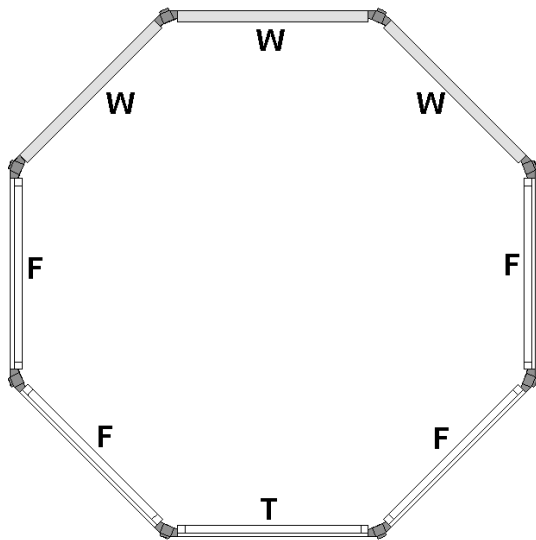

234.2828.30.00

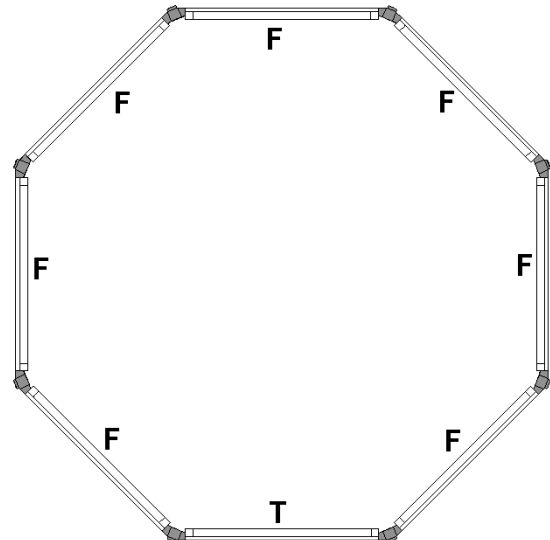

D	Bodenelement		
GB	Floor element	H	padlóelem
F	élément de sol	NL	vloerelement
I	elemento del pavimento	HR	podni element
E	Panel del piso	SLO	talni element
P	Elemento do soalho		

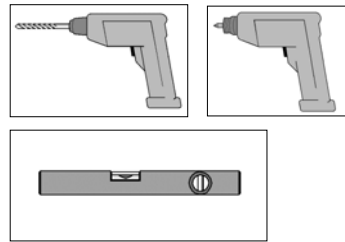

3

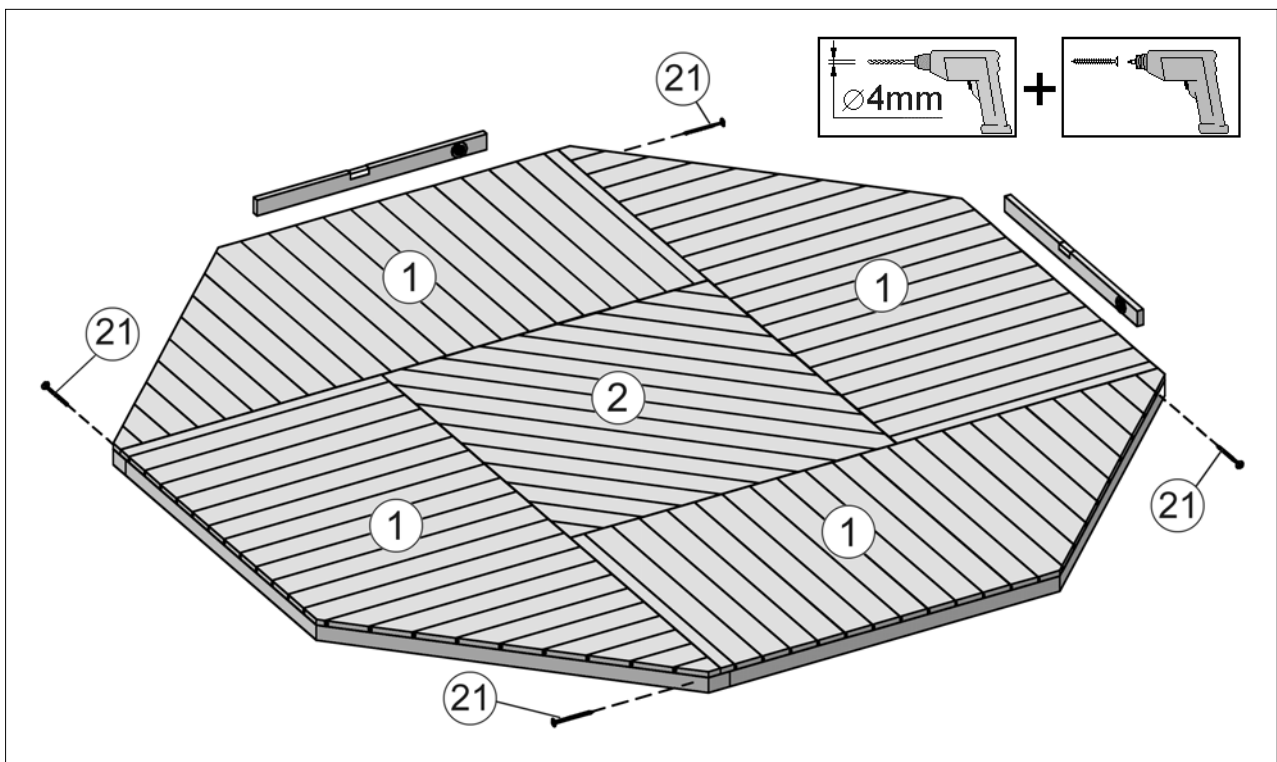
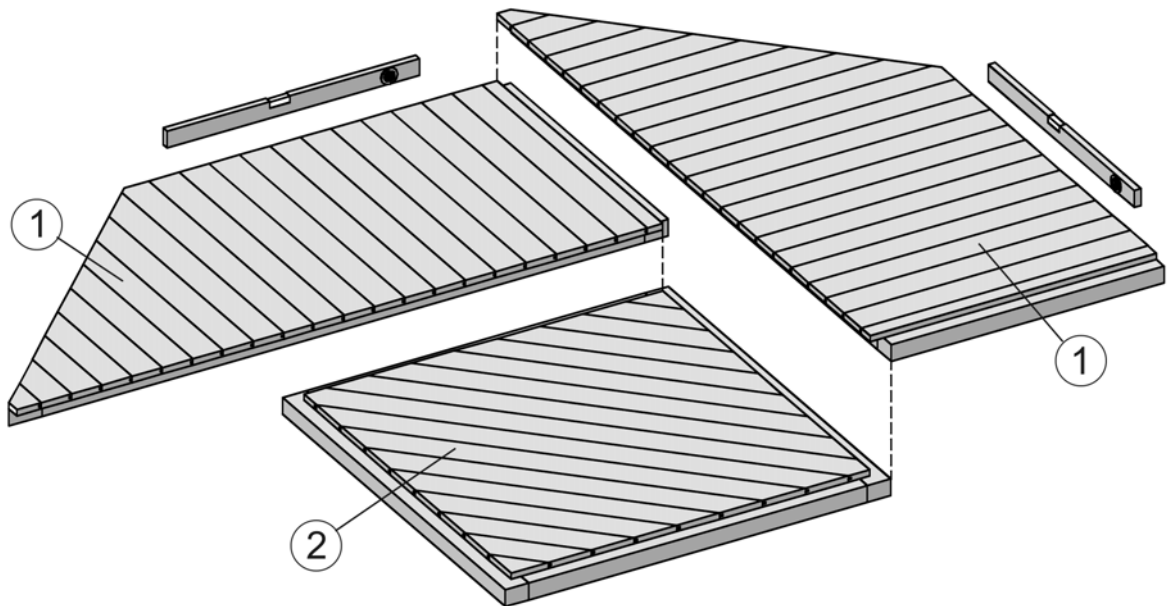

D	Wandelemente		
GB	Wall element	H	falelem
F	élément de paroi	NL	wandelement
I	elemento da parede	HR	zidni element
E	Panel mural	SLO	Stenski element
P	Elemento de parede		

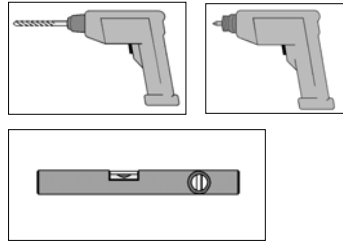

4

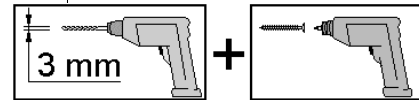
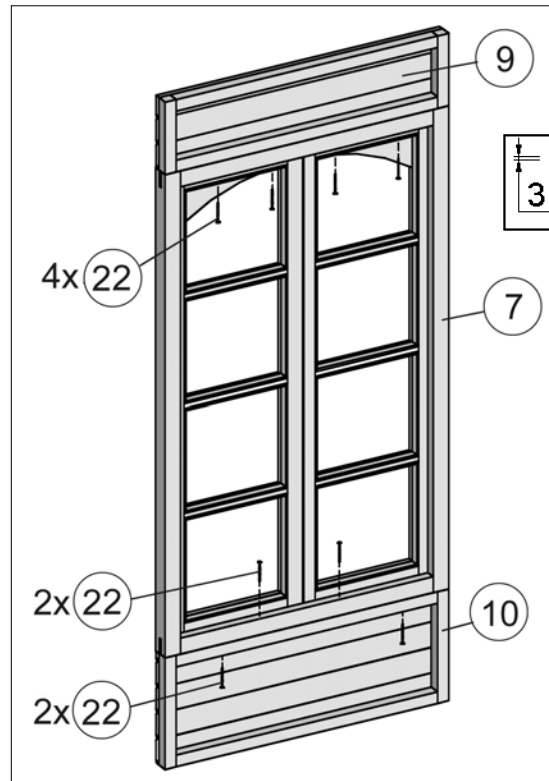

5

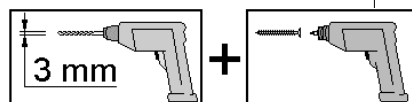
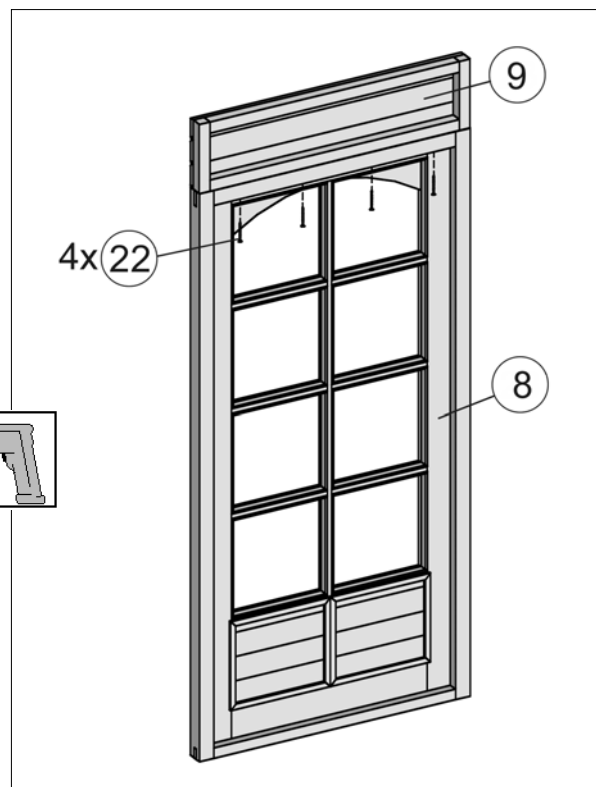

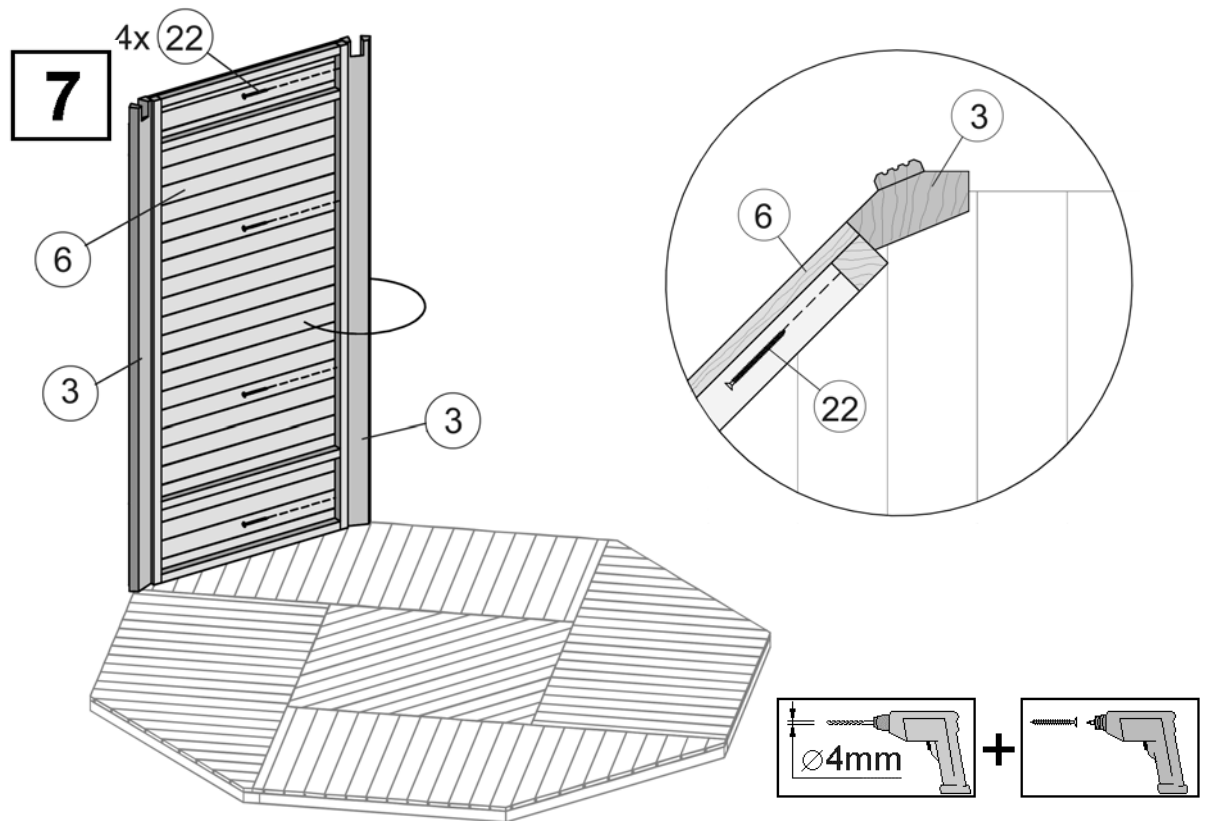
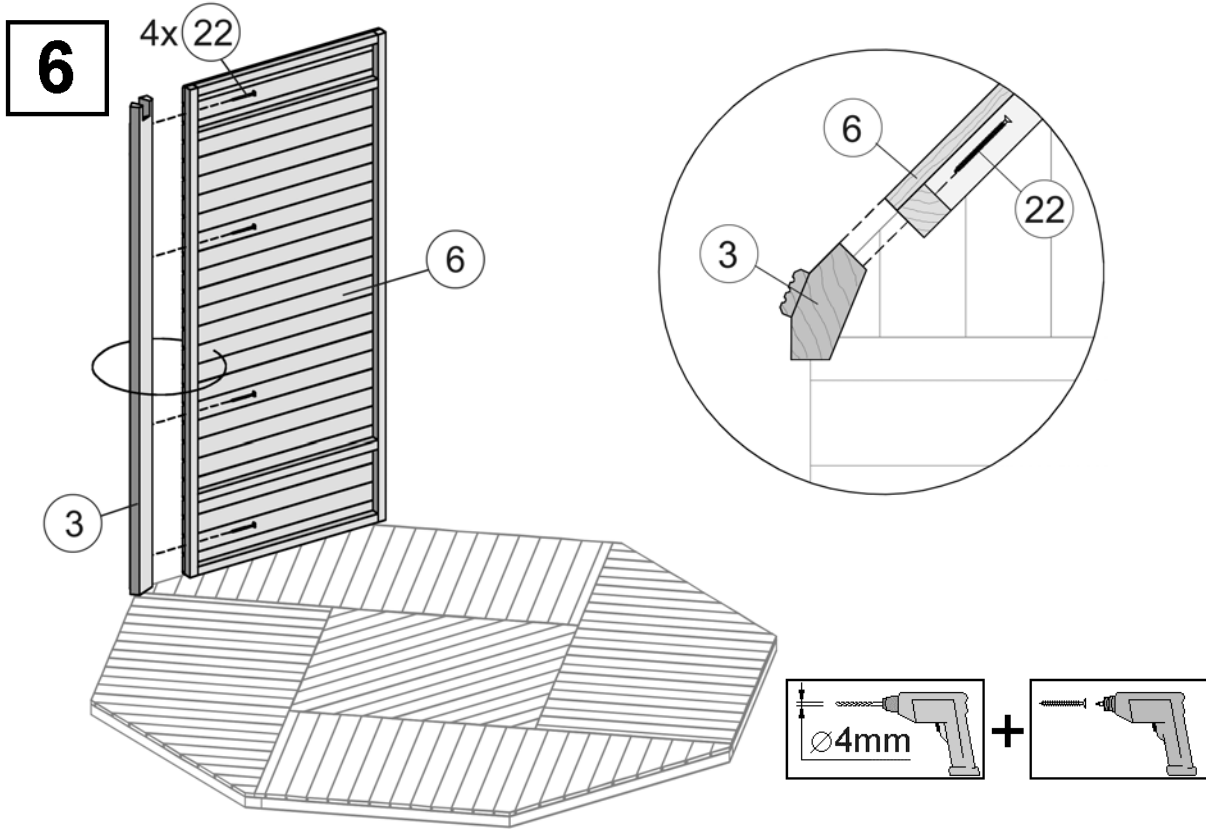
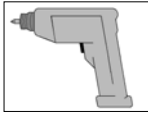
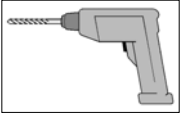

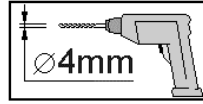
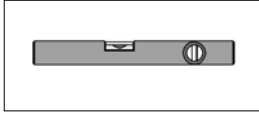
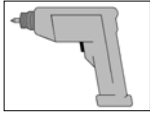
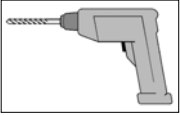

+

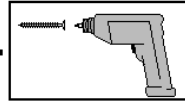

8

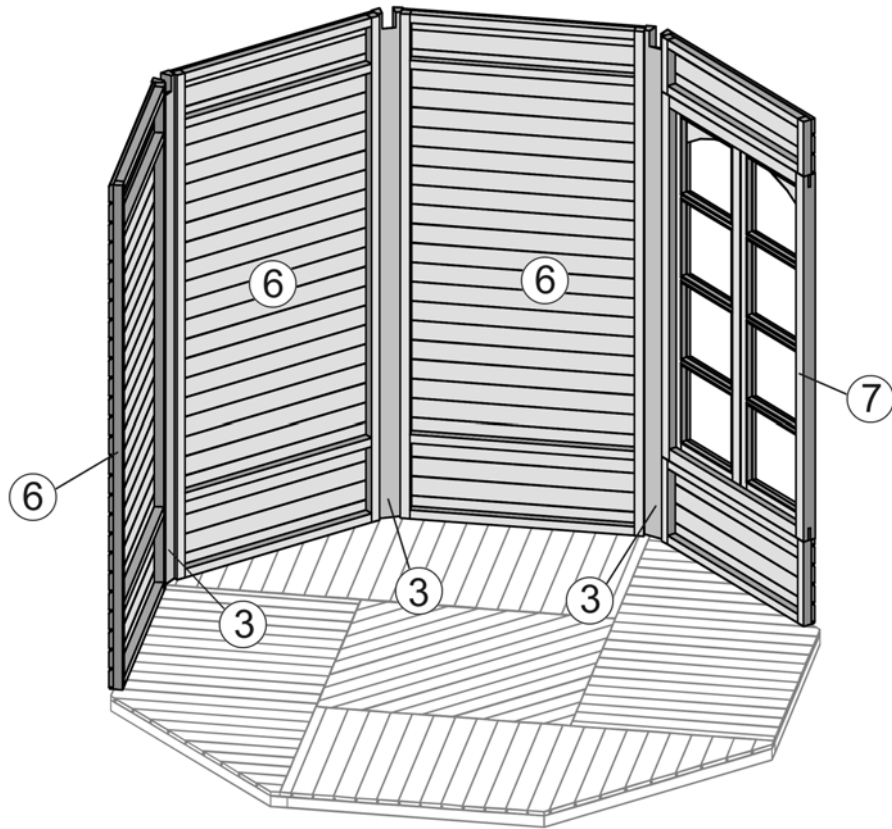

9

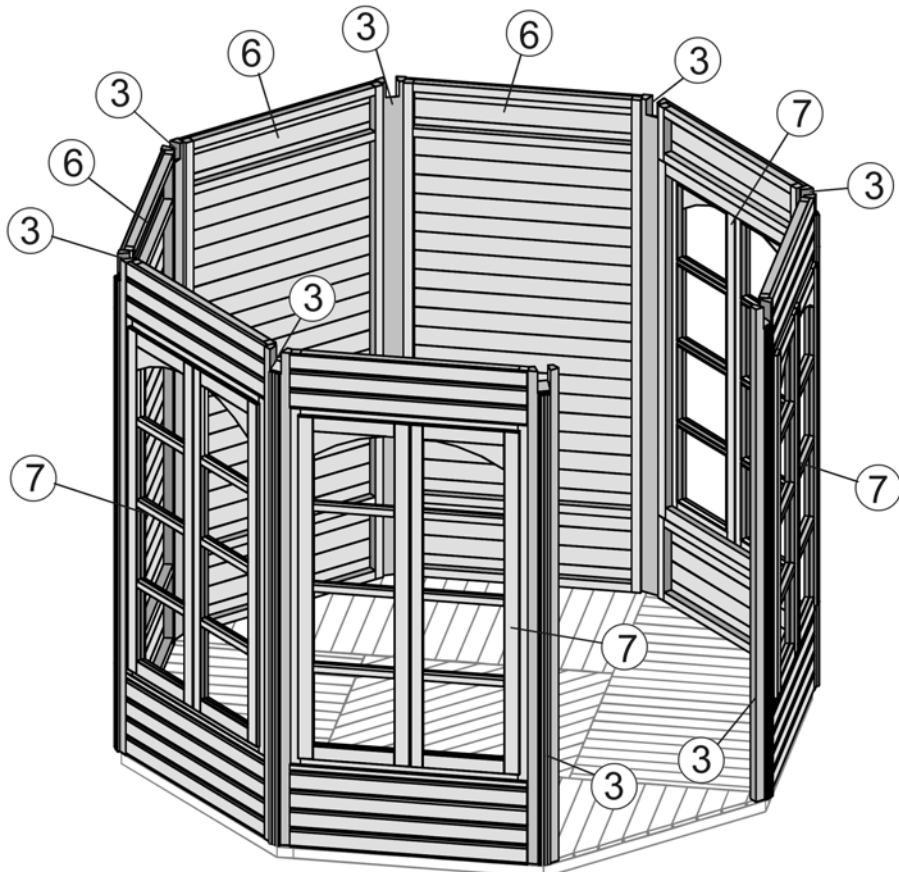

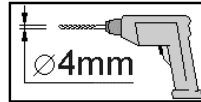
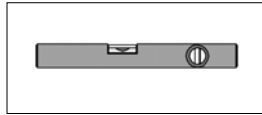
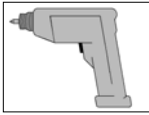
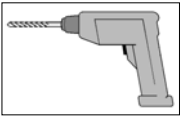

+

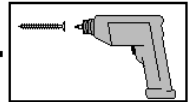

234.2828.20.00

10

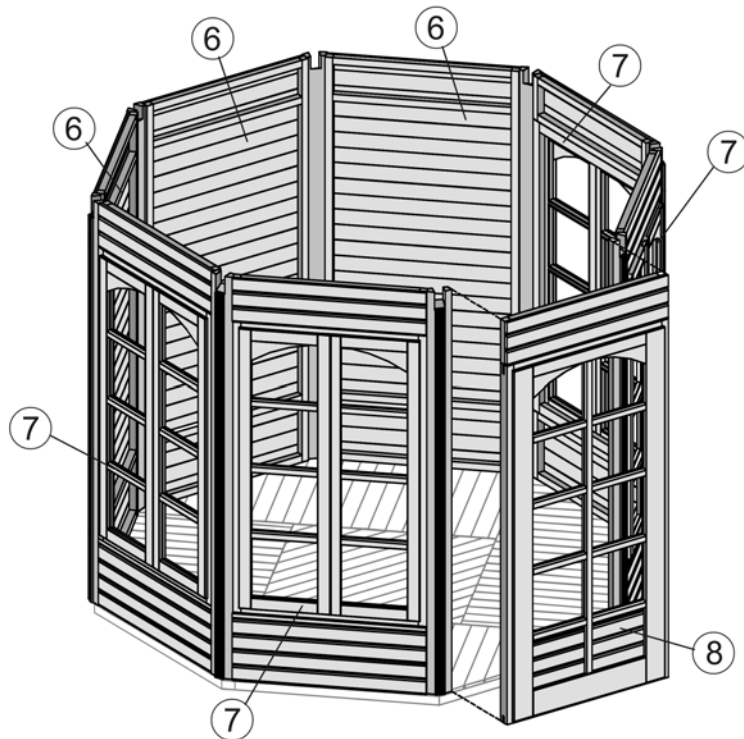

234.2828.30.00

11

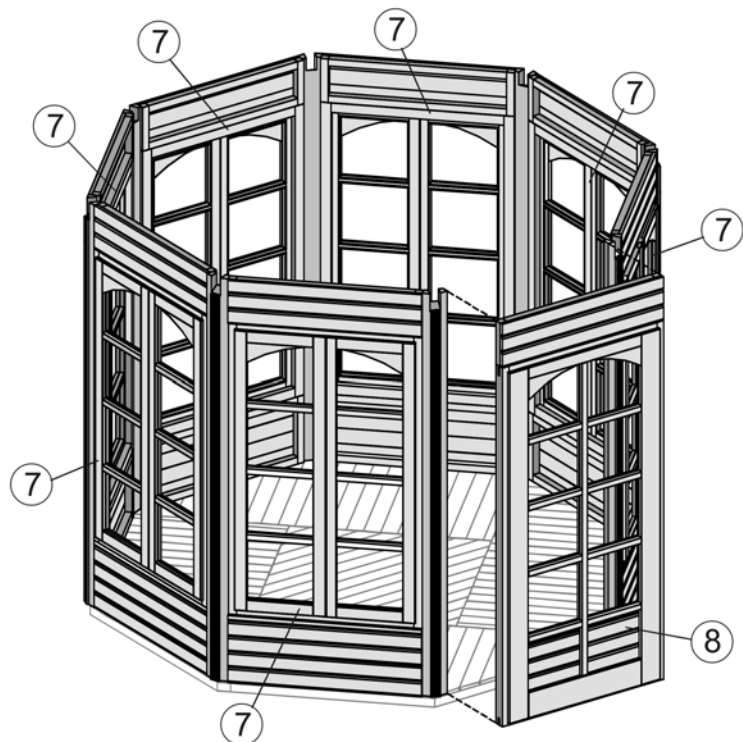

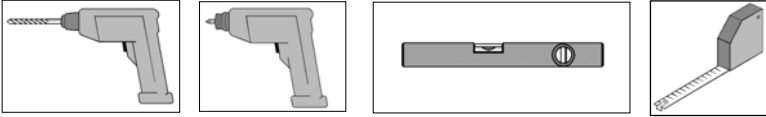

12

1.

a = a!

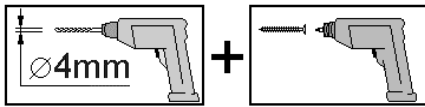
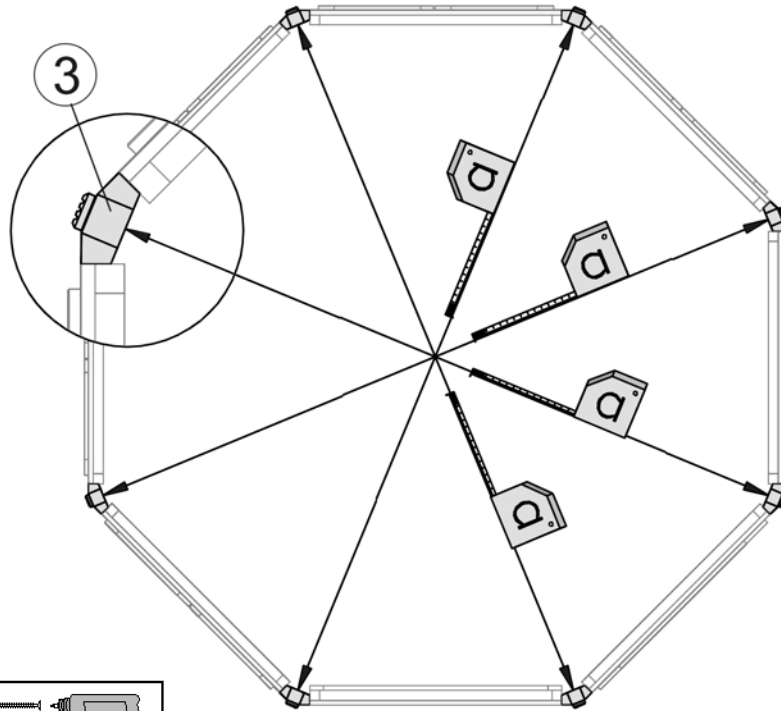

2.

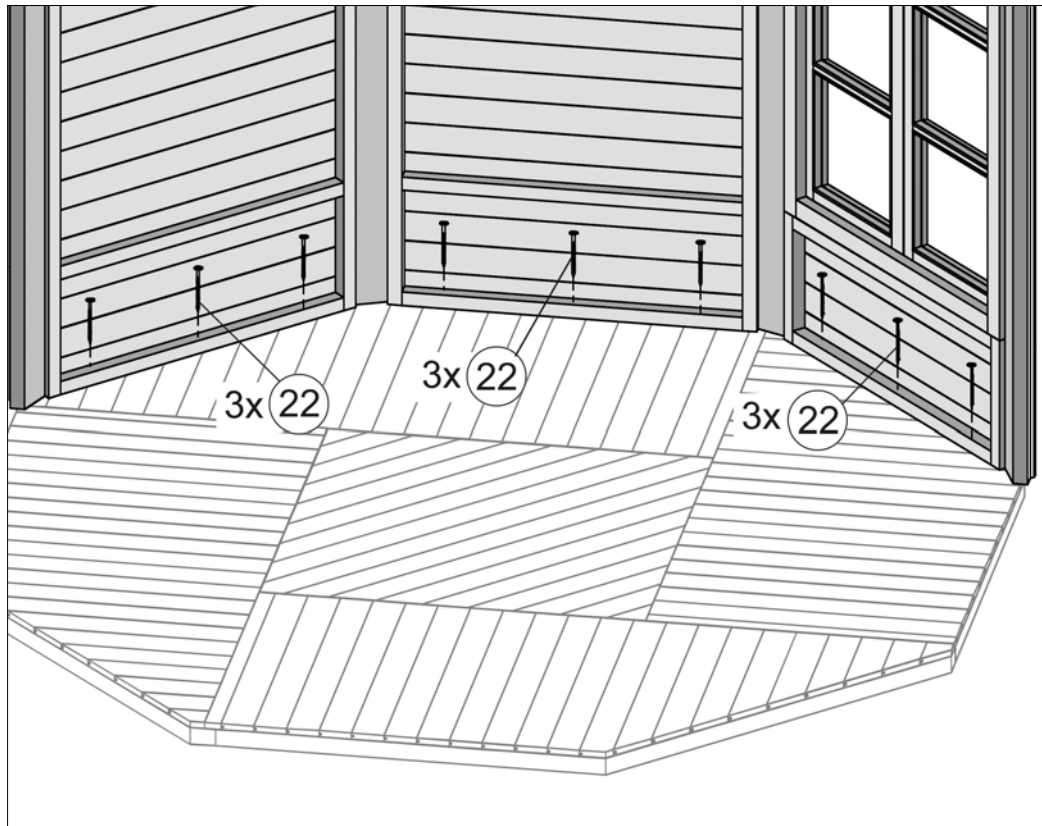

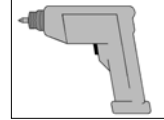
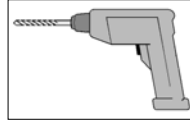
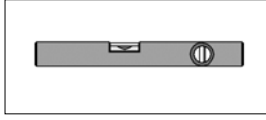
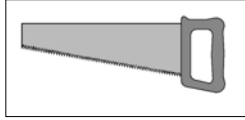
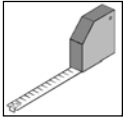

13

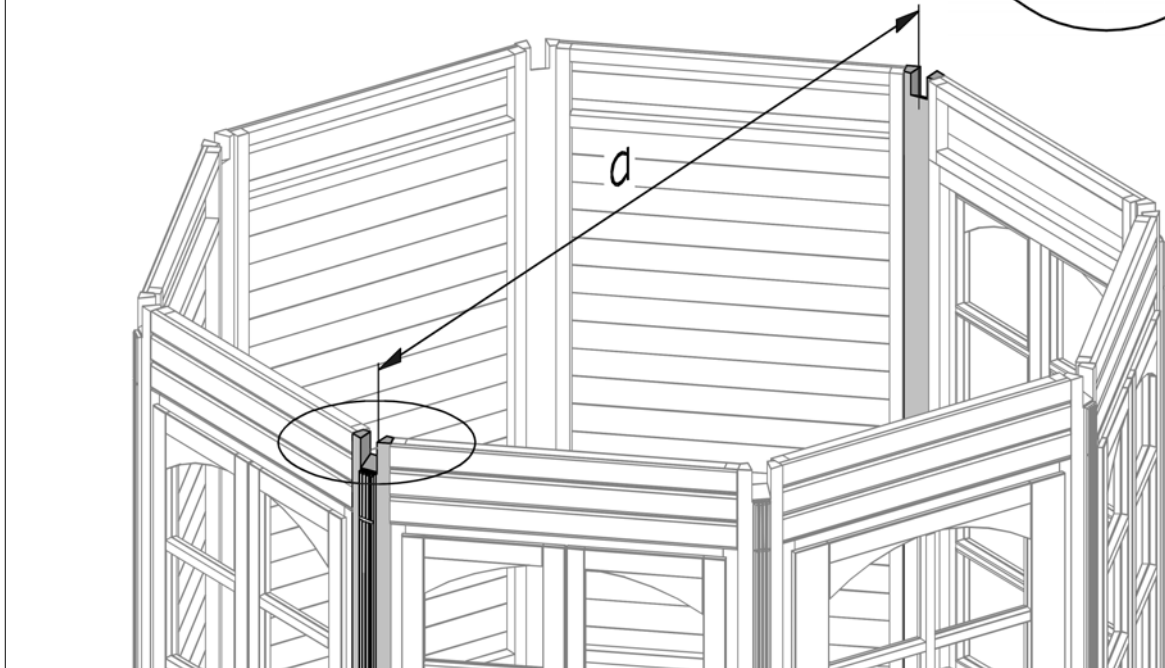
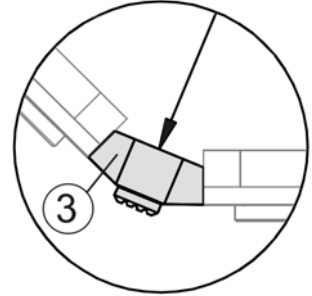

14

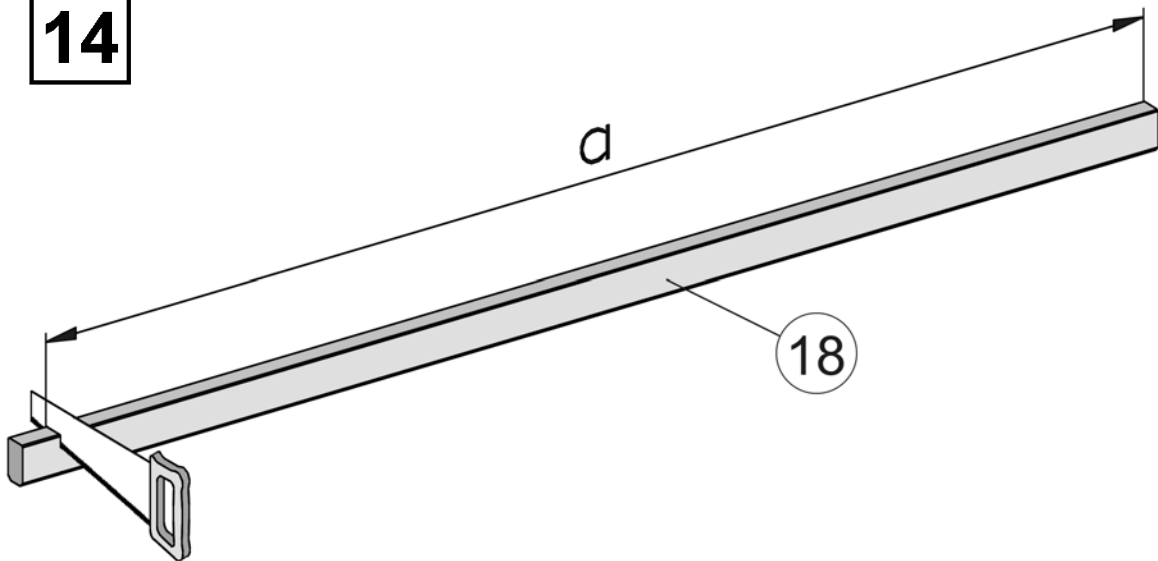

D	Dachkonstruktion		
GB	Roof assembly	H	Tetőkonstrukció
F	montage du toit	NL	dakconstructie
I	montaggio del tetto	HR	Krovna konstrukcija
E	Montaje de la cubierta	SLO	ostrešje
P	Montagem do telhado		

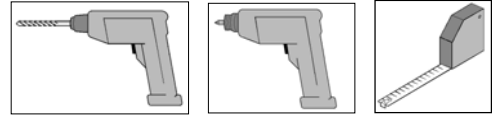

15

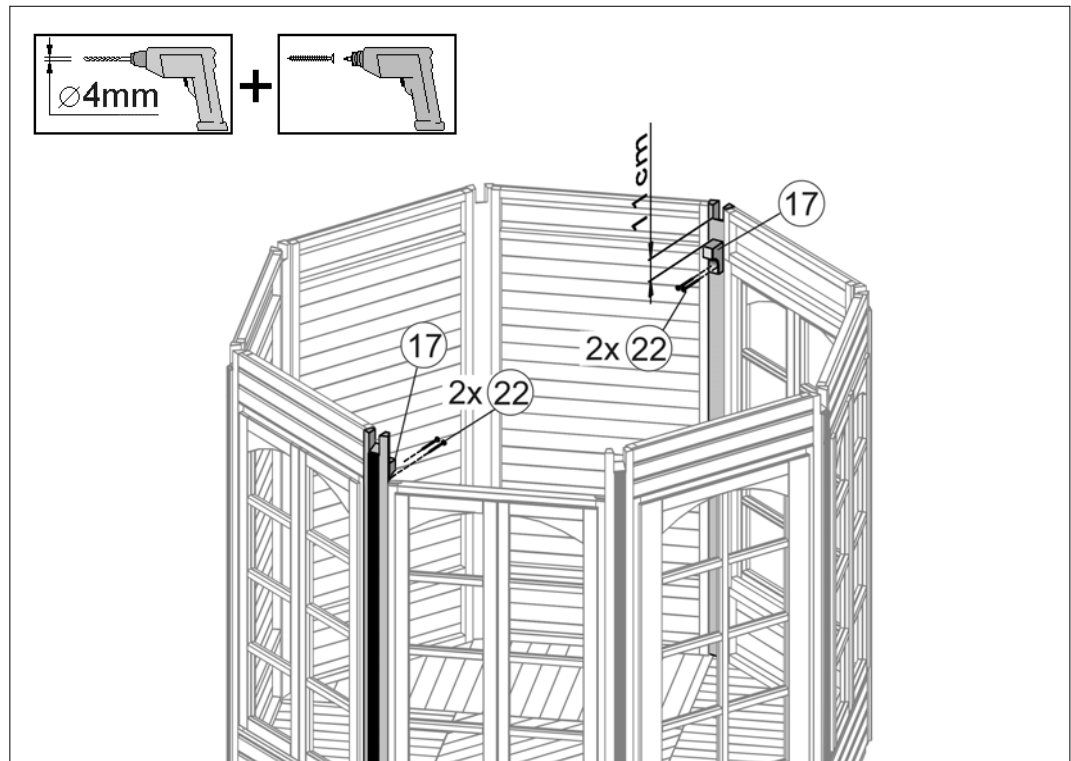
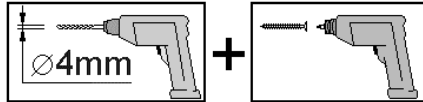

16

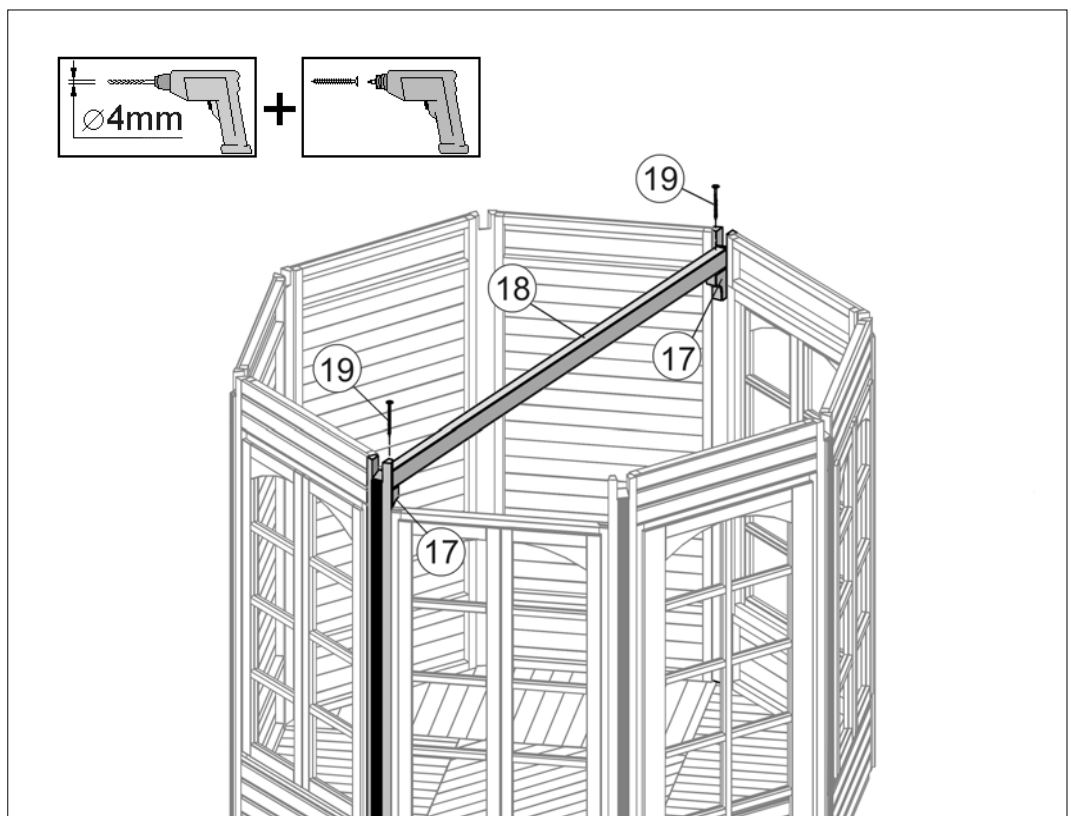
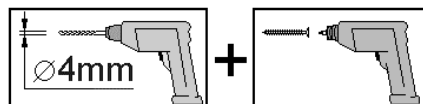

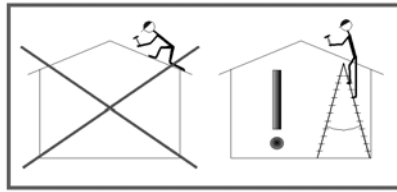
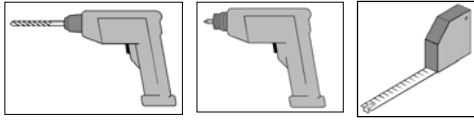

17

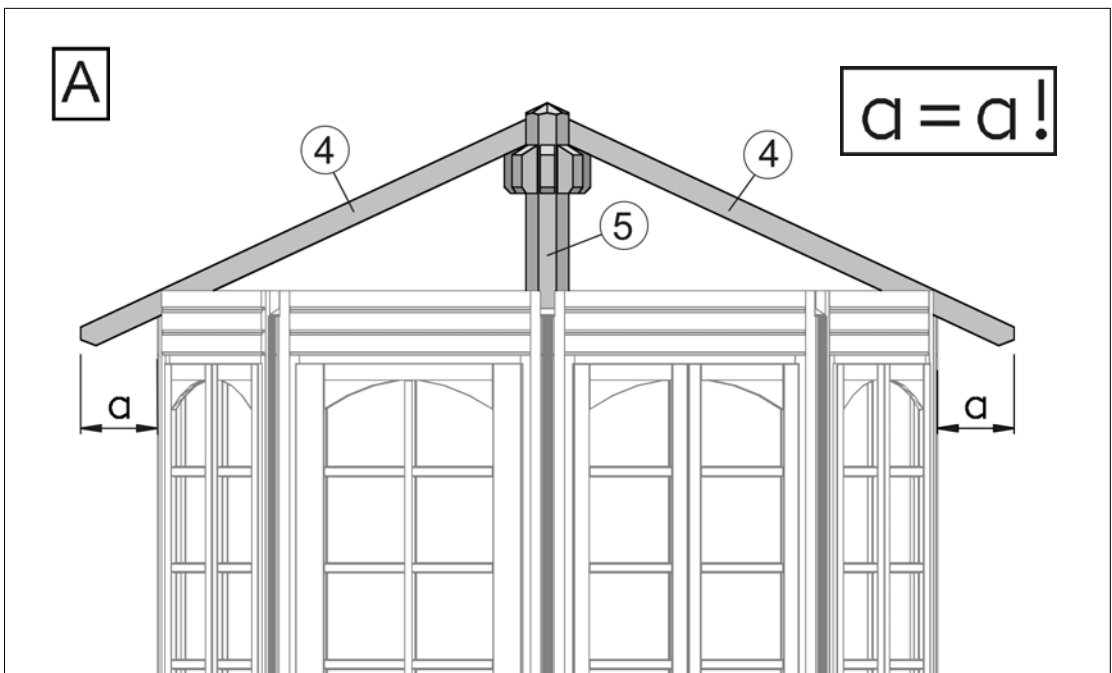
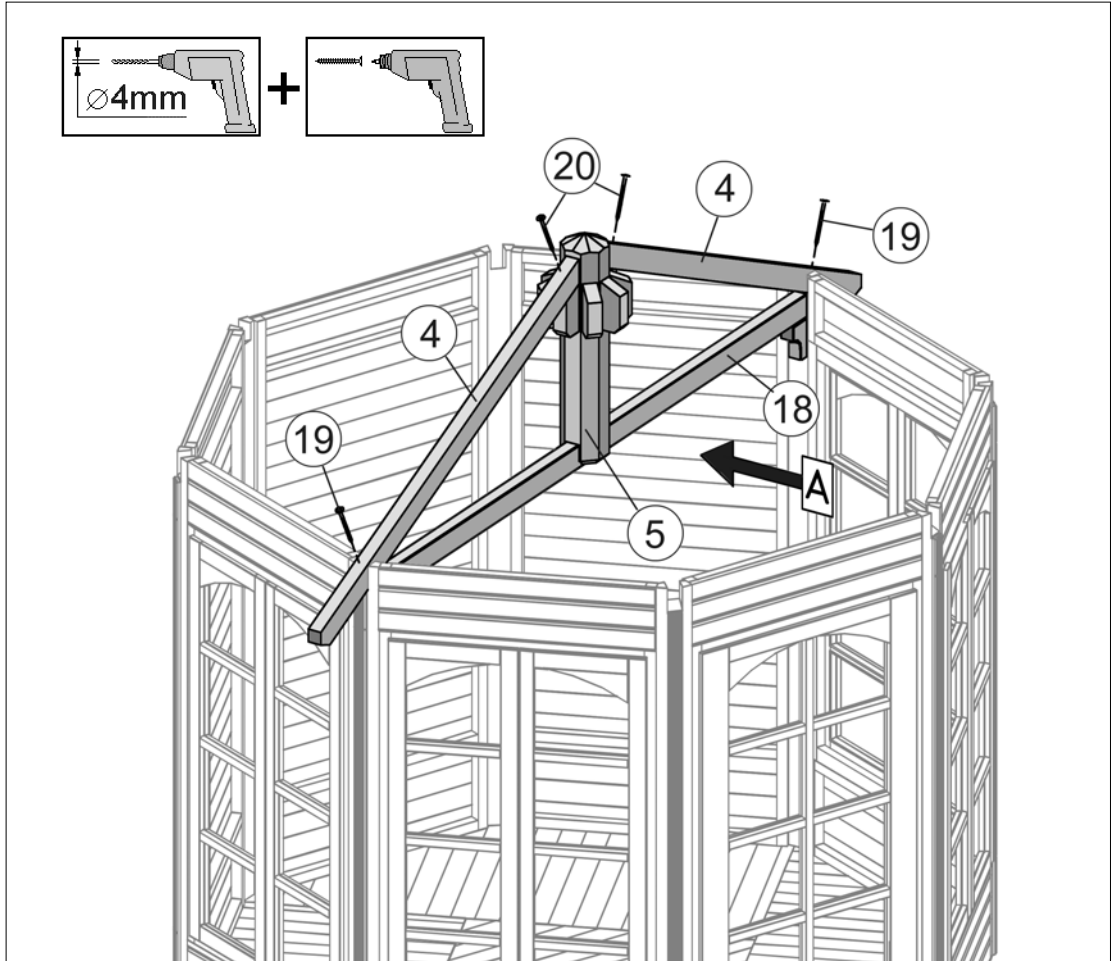
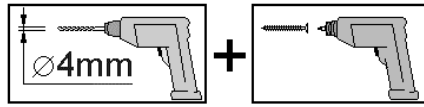

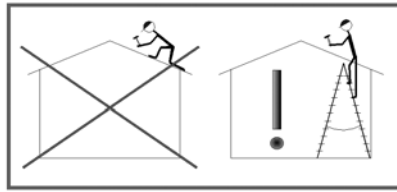
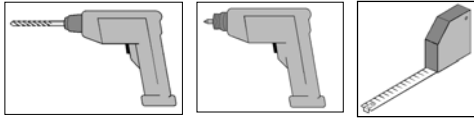

18

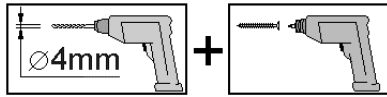

a = a!

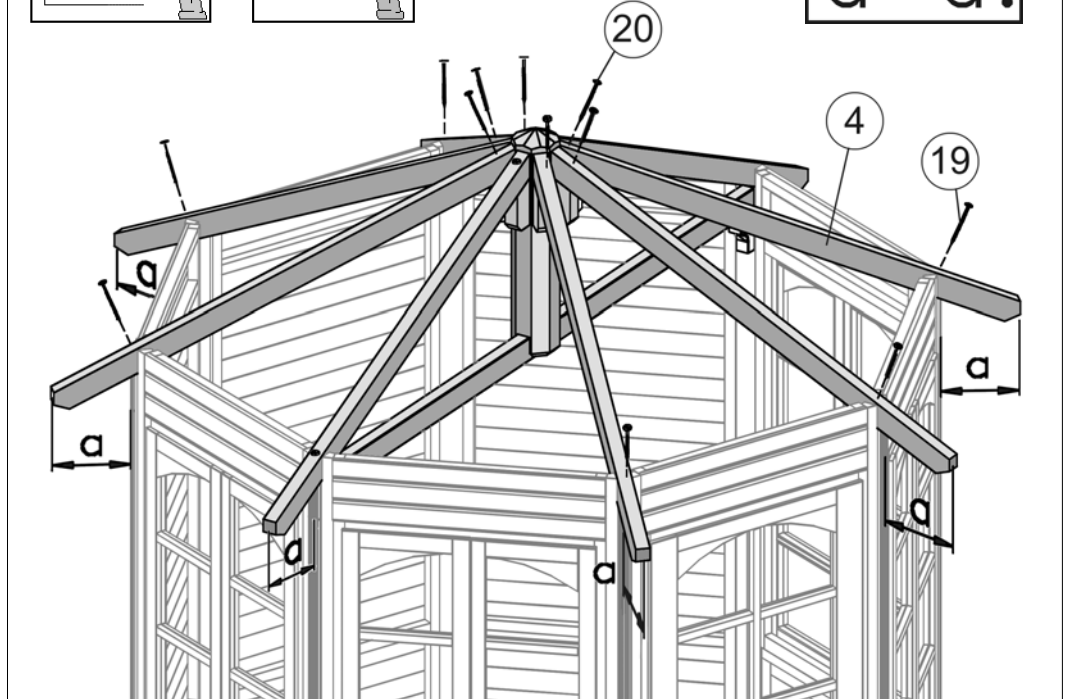

19

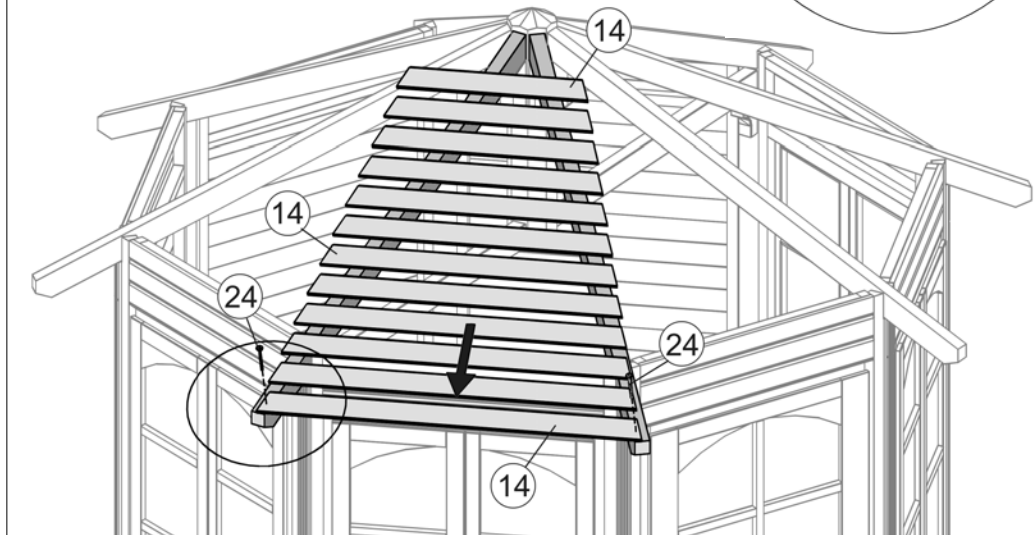
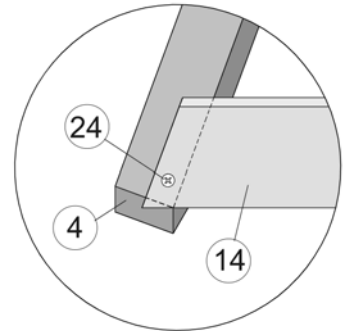
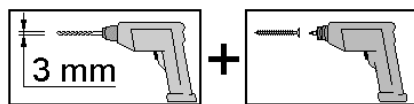

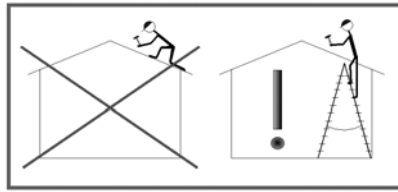
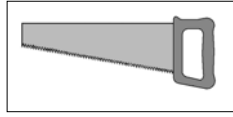
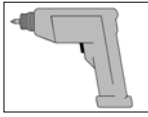
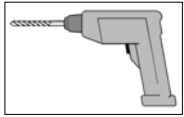

20

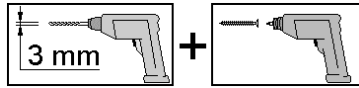

2x 24

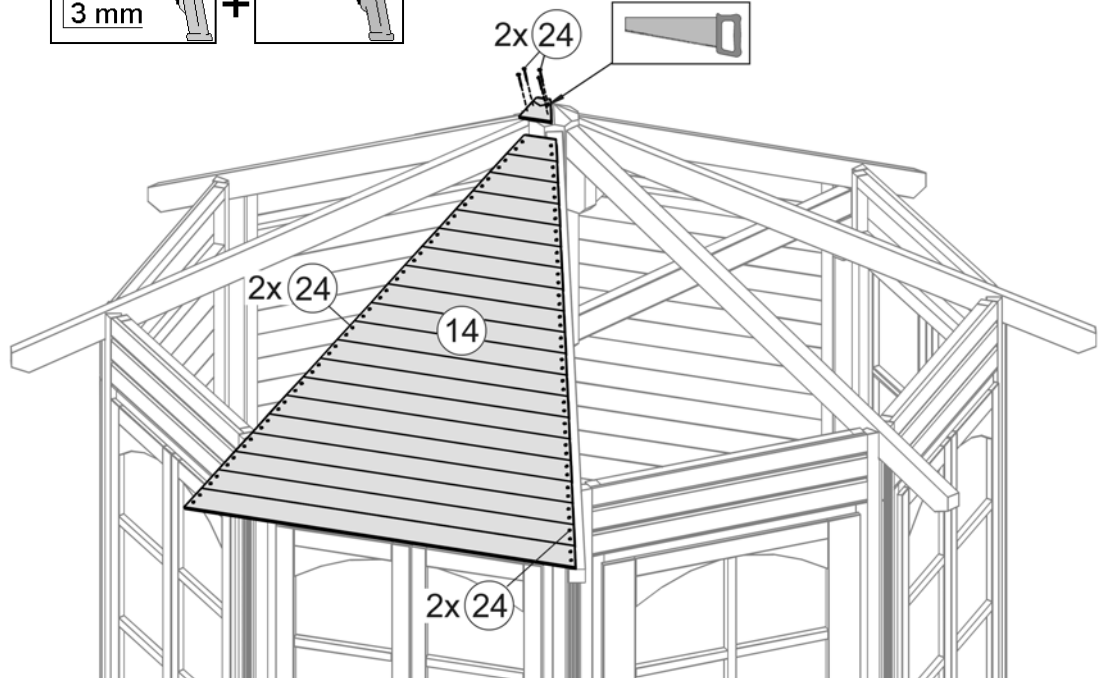
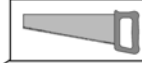

21

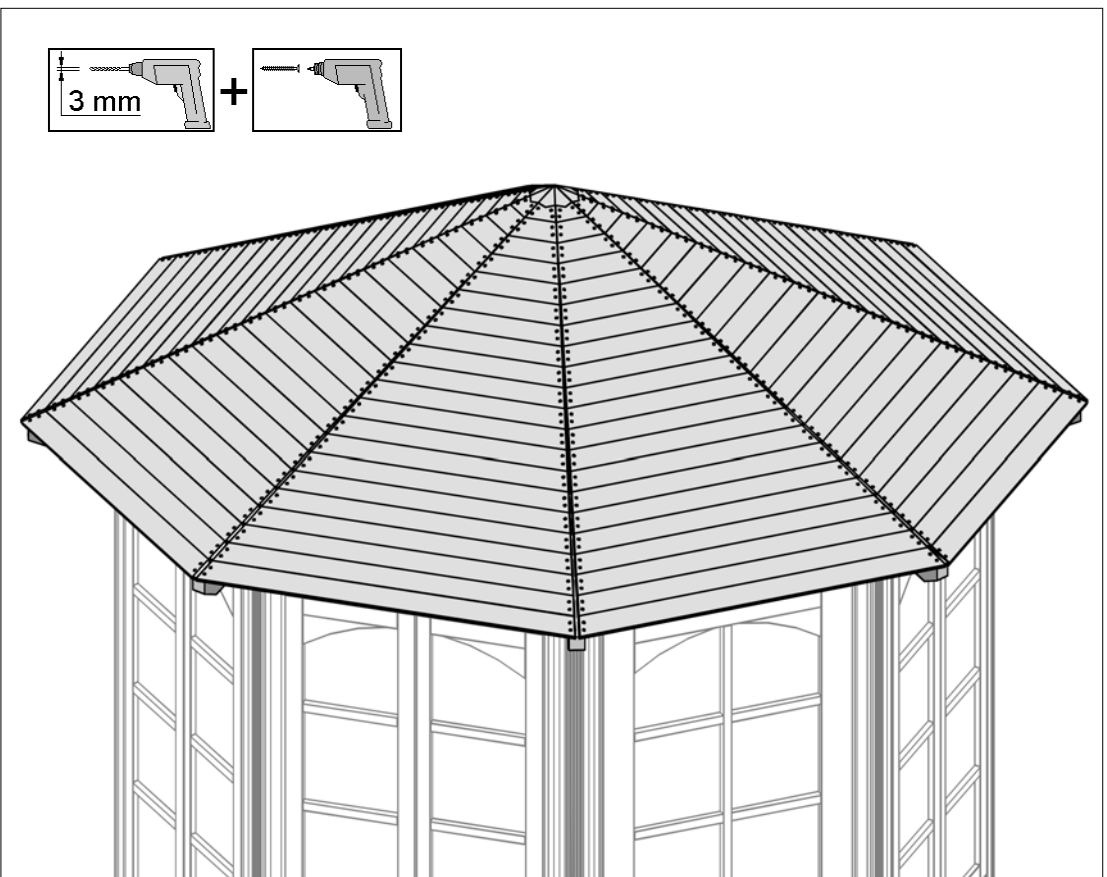
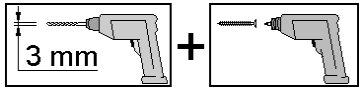

D	Abdeckleiste		
GB	Roof plate	H	fedőléc
F	plaque de couverture	NL	afdeklíjst
I	piastra del tetto	HR	izolacijska letvica
E	Paneles de cubierta	SLO	zaključna letev
P	Placa do telhado		

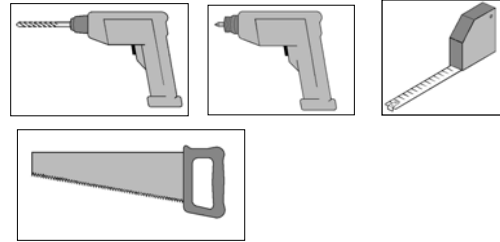

22

8x

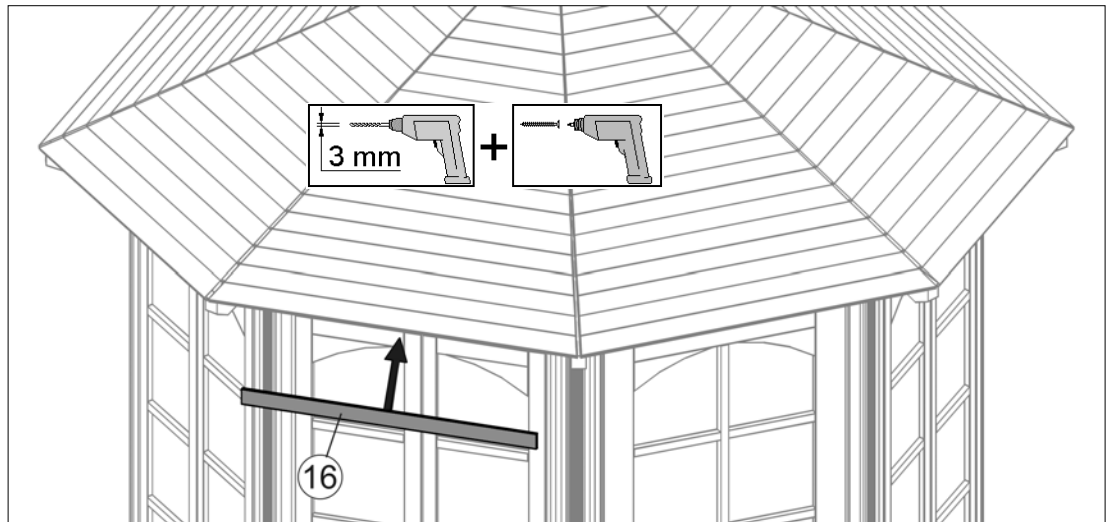

1.

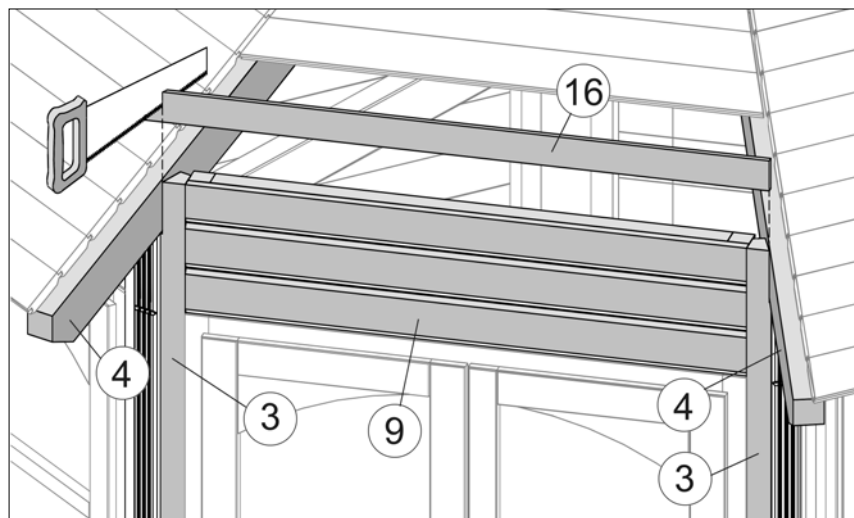

2.

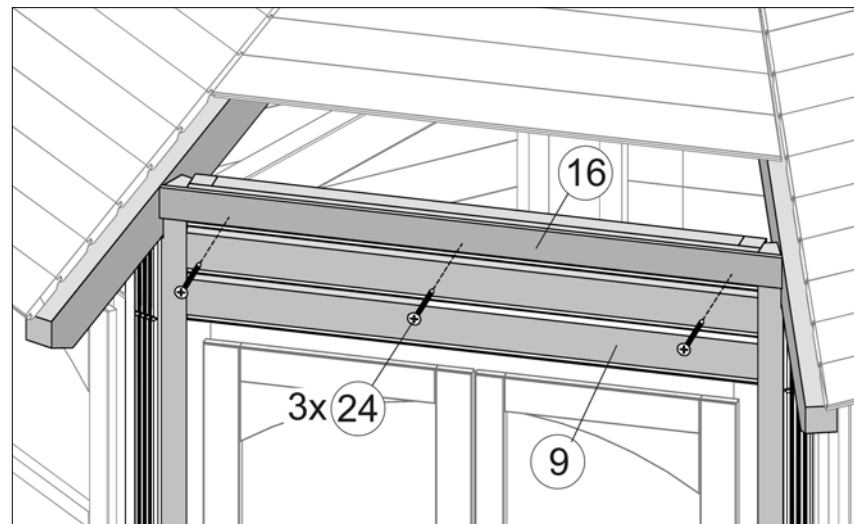

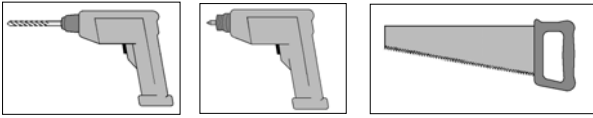

23

8x

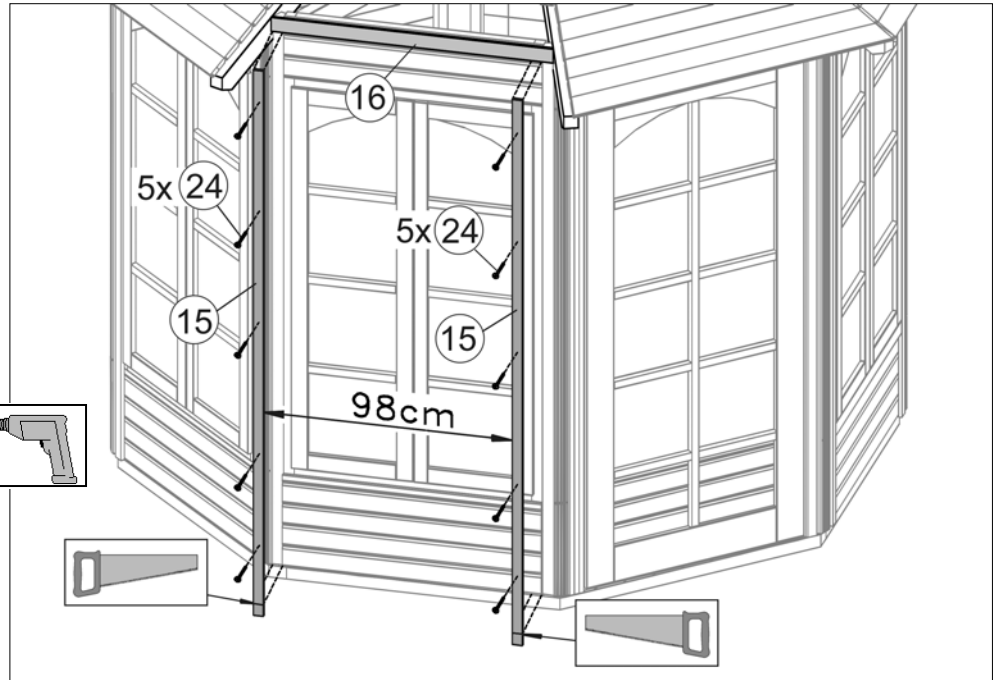
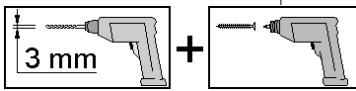

24

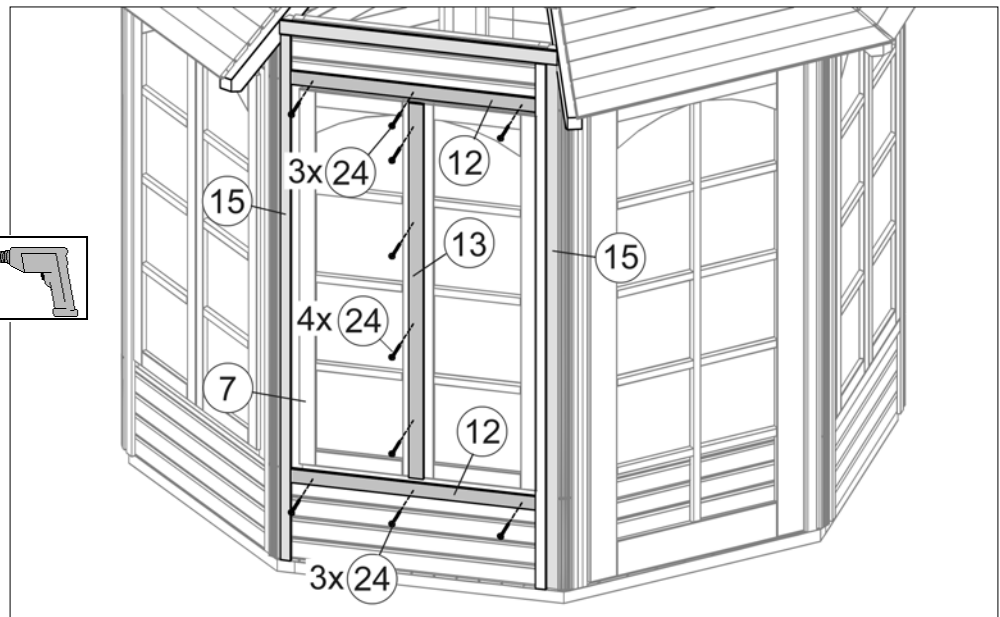
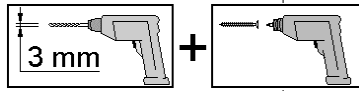

25

7x

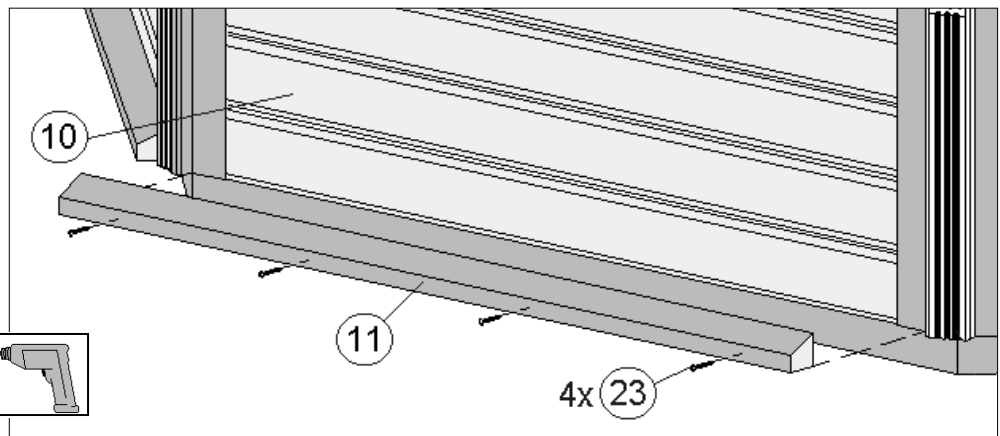
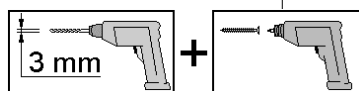

D	Drückergarnitur		
GB	Printer's equipment	H	kilincskészlet
F	garniture de loquet	NL	deurklinken
I	completo maniglia	HR	garnitura za pritiskanje
E	Juego de impresión	SLO	garnitura pritiskačev
P	Drückergarnitur		

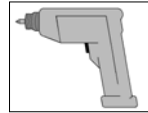

26

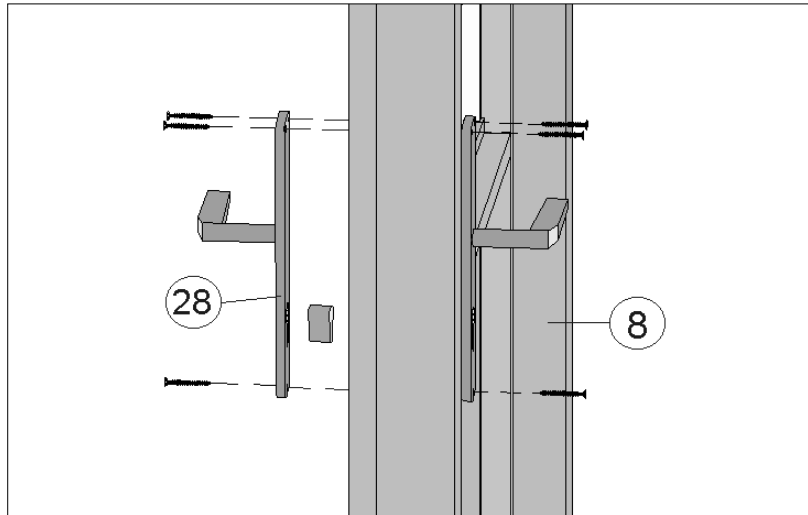

D	Fenstergriff		
GB	Window handle	H	ablakkilincs
F	poignée de fenêtre	NL	raamgreep
I	maniglia della finestra	HR	držka prozora
E	Manija de la ventana	SLO	okenska kljuka
P	Manípulo da janela		

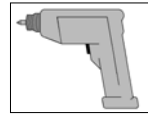

27

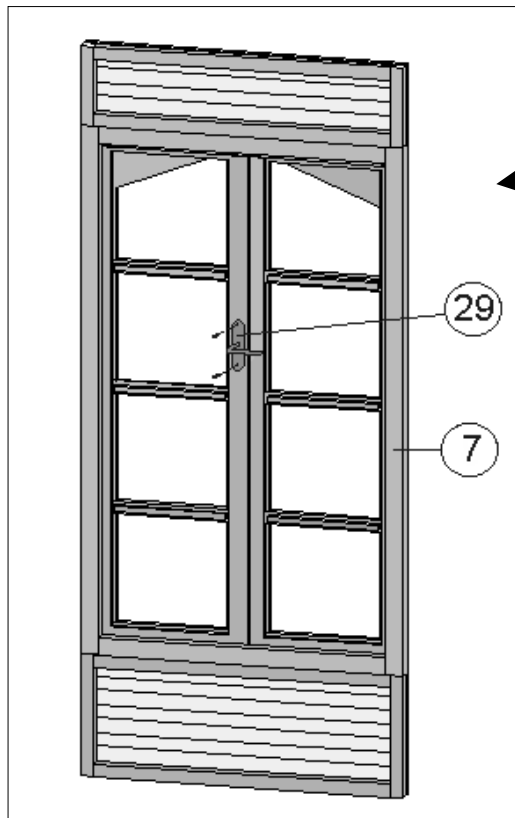

D	innen
GB	inside
F	intérieur
I	interno
E	interior
P	interior
H	belül
NL	binnen
HR	unutra
SLO	znotraj

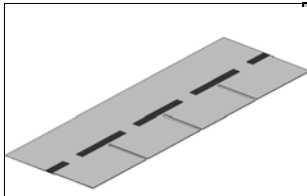

D	Bitumenschindel		
GB	Bitumen shingle	H	bitumenes zsindely
F	bardeau bitumé	NL	bitumen dakshingle
I	scidula in bitume	HR	šindra od bitumena
E	Ripias de betún	SLO	bitumenska škodla
P	Telha asfáltica		

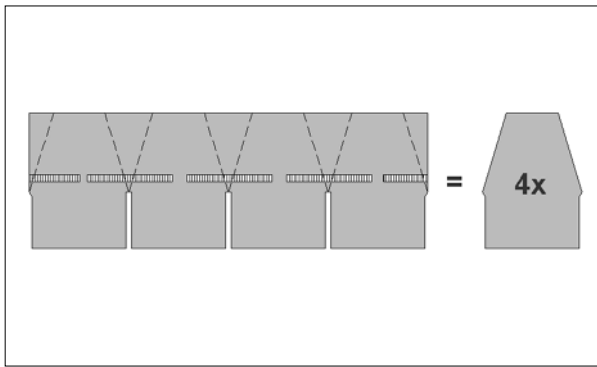
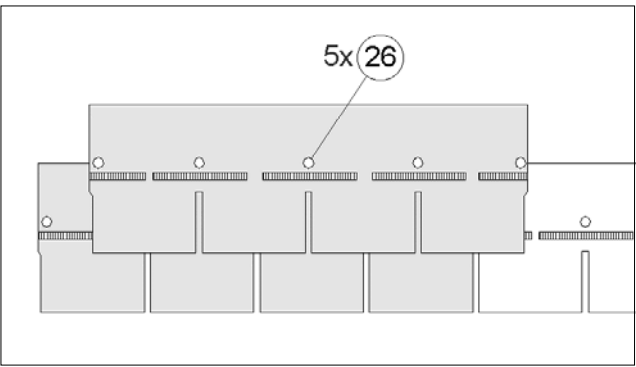
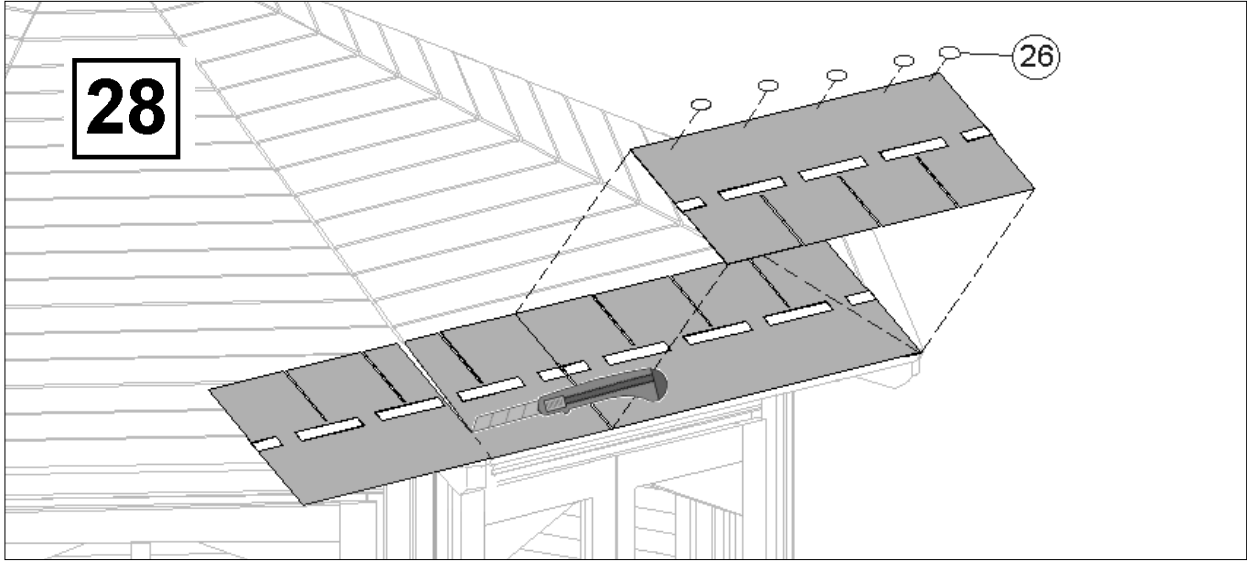
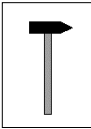
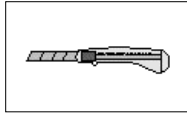

29

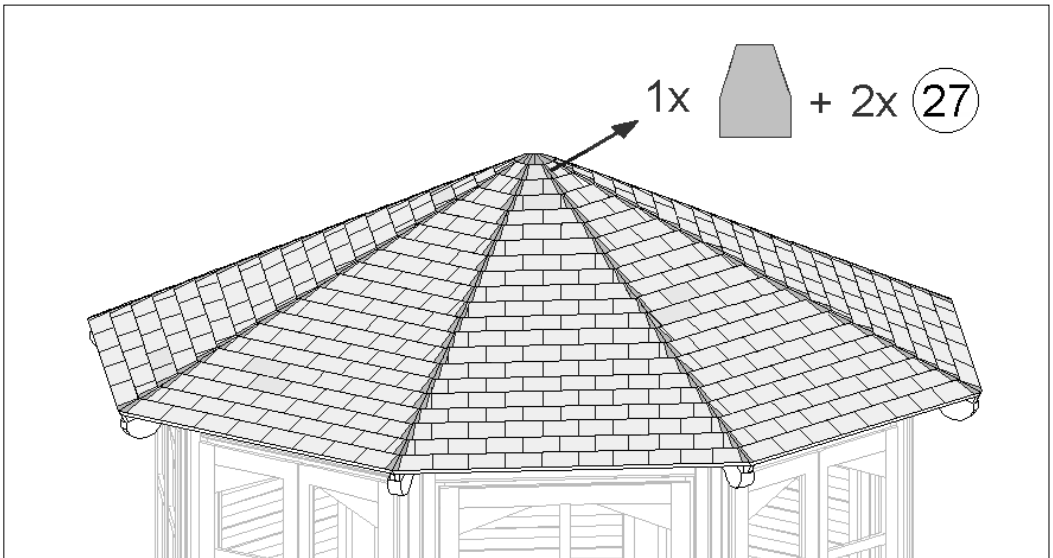

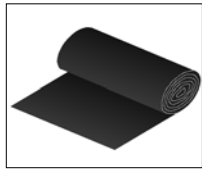

D	Dachpappe		
GB	Roof paper	H	fedéllemez
F	carton bitumé	NL	asfaltpapier
I	cartone catramato	HR	krovni karton
E	Cartón asfáltico	SLO	strešna lepenka
P	Papelão da cobertura		

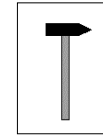
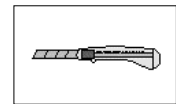
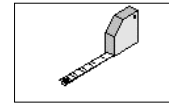

30

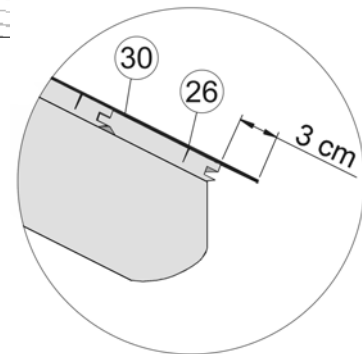
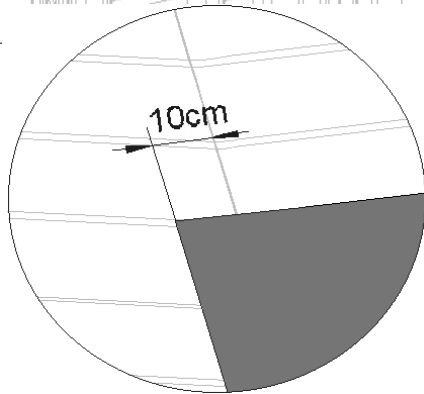
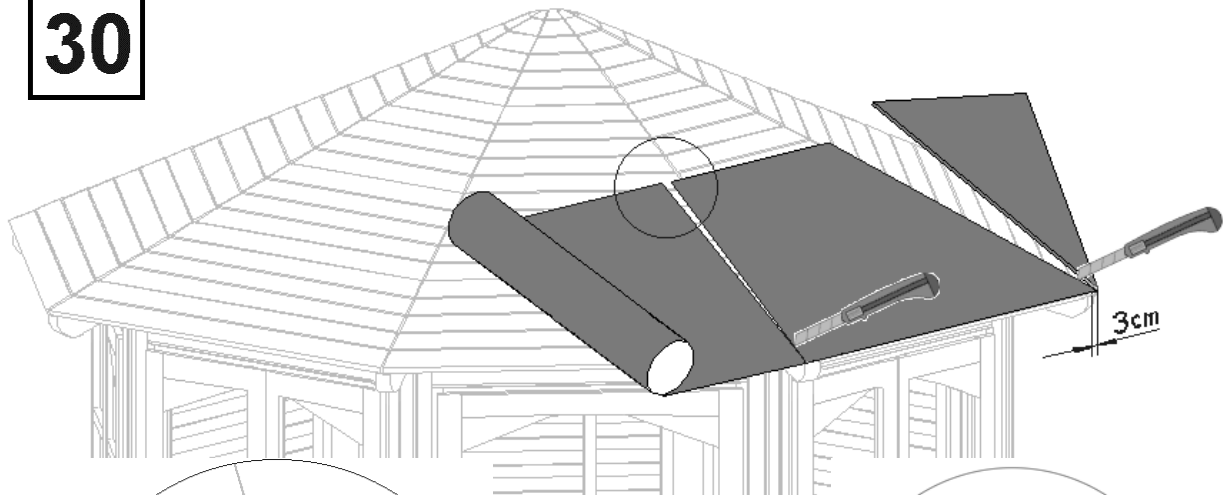

31

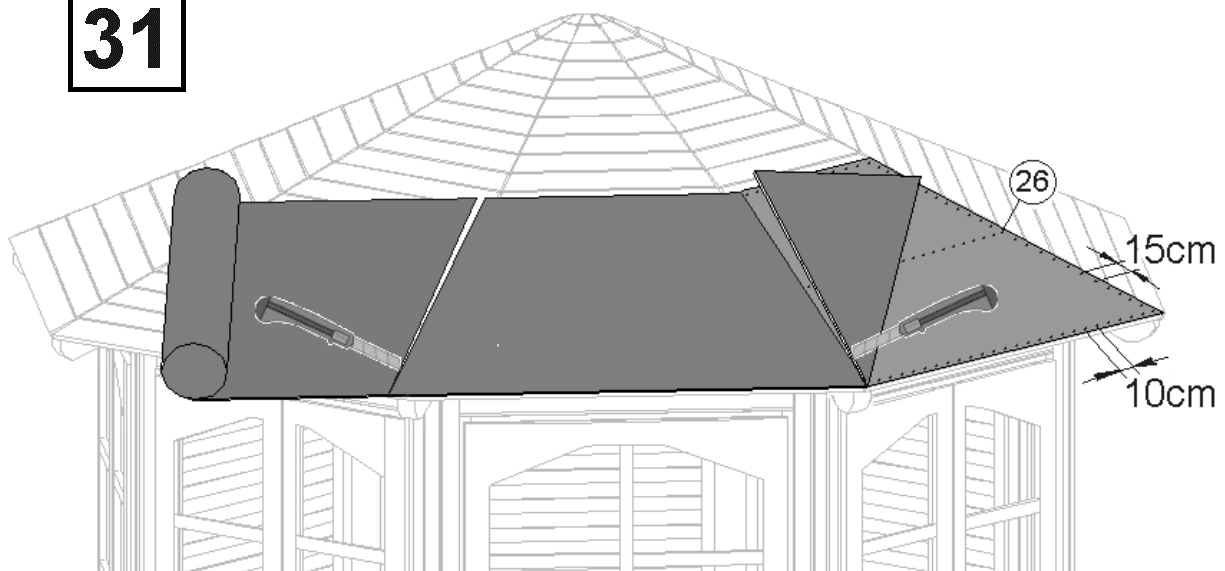

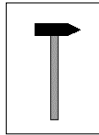
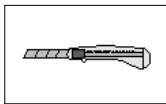
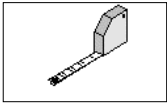

32

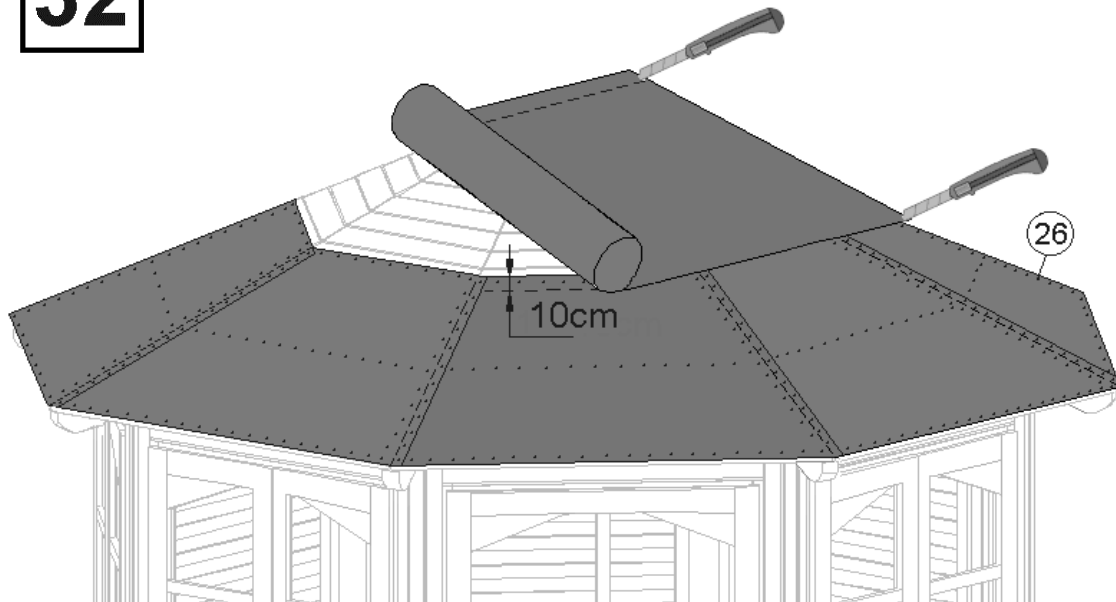



weka Holzbau GmbH,
Johannesstr. 16
D-17034 Neubrandenburg
Tel.: 0395 42908-0
Fax: 0395 42908-83

MA Art.-Nr.: 800.0286.07.34