



# Montage-, Bedienungs- und Wartungsanleitung

en	ASSEMBLY, USER AND MAINTENANCE INSTRUCTIONS
fr	NOTICE DE MONTAGE, D'UTILISATION ET D'ENTRETIEN
it	ISTRUZIONI DI MONTAGGIO, USO E MANUTENZIONE



## Weka „Garten[Q]“ Kompakt

Art.-Nr. 415.2014.20000  
415.2014.23000  
415.2014.25000  
415.2014.26000

Stand: 1433

**- de -**

## **Sehr geehrte Kundin, sehr geehrter Kunde,**

Lesen Sie diese Anleitung vor dem Aufbau bitte vollständig durch, um Montagefehler oder Beschädigungen zu vermeiden.

### **WICHTIG !**

**Prüfen Sie bitte sofort anhand der Packliste, ob das Gerätehaus vollständig und unbeschädigt bei Ihnen angekommen ist.**

Bitte vernichten Sie die Packliste erst nach Ablauf der Garantiezeit. Diese Liste dient Ihnen zur Kontrolle auf Vollständigkeit der Einzelteile und ist mit dem Kaufbeleg aufzubewahren. Eventuelle Beanstandungen können mit Hilfe dieser Liste problemlos behoben werden.

Wir empfehlen Ihnen die Montage mit 2 Personen durchzuführen.

Zur Verhütung von Unfällen ist zu vermeiden, daß sich Kinder während der Montage in unmittelbarer Nähe aufhalten.

Weiterentwicklungen im Sinne des technischen Fortschritts behalten wir uns vor. So können geringfügige Abweichungen in den Darstellungen entstehen.

Verpackungsmaterial nicht einfach wegwerfen! Papier-, Pappe- und Wellpappeverpackungen, sowie Kunststoffverpackungsteile sollten in die entsprechenden Sammelbehälter gegeben werden.

## **Empfehlungen**

Voraussetzung für die fachgerechte Montage ist ein absolut **waagrechtes** und rechtwinkliges Fundament.

Wir empfehlen eine Fundamentplatte. Einen Fundamentplan erhalten Sie bei Ihrem Fachhändler! Das Verlegen von Betonplatten (z.B. Rasenbordsteine oder Gehwegplatten) auf gewachsenem oder gut verdichteten Boden ist ebenfalls möglich.

Um aufsteigende Feuchtigkeit zu verhindern, empfehlen wir, zwischen dem Fundament und den Bodenbalken eine Sperrschicht aus der Verpackungsfolie, Dachpappe o.ä. zu verlegen.

Die Sperrschicht aus Dachpappe ist nicht im Lieferumfang enthalten.

Die Zwischenräume der Bodenbalken gewährleisten eine notwendige Unterlüftung des Hauses.

Gegen Windschäden ist das Haus mit dem Fundament zu verankern. Hierzu eignen sich im Fachhandel erhältliche Betonanker oder Stahlwinkel, die an den 4 Hausecken befestigt und mit dem Fundament verbunden werden. Die Verankerung gehört nicht zum Lieferumfang.

Bitte bohren Sie alle Schraubverbindungen vor, um Beschädigungen an den Holzteilen zu vermeiden!

Folgendes Zeichen macht Sie während der Anleitung nochmals darauf aufmerksam:

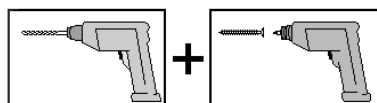

Die mitgelieferte Wetterschutzlasur ist zur Beseitigung kleiner Lackschäden, die bei der Montage entstehen können, vorgesehen.

## **Holzschutz**

Schützen Sie unbehandeltes Holz vor und während des Aufbaus vor direkter Sonneneinwirkung oder Feuchtigkeit!

Das Produkt besteht aus dem natürlichen Rohstoff Holz. Dies macht regelmäßig ausreichende Holzschutzmaßnahmen zwingend erforderlich. Für die fachgerechte Holzschutzbehandlung wenden Sie sich bitte an einen Holzschutzfachmann.

Holzschutzmaßnahmen sind vom Kunden in eigener Verantwortlichkeit durchzuführen. Ohne vorschriftsmäßigen Holzschutz kann keine Gewährleistung übernommen werden. Bitte beachten Sie auch die diesbezüglichen Bestimmungen in unseren Garantieerklärungen.

Wir wünschen Ihnen viel Freude mit Ihrem Holzprodukt.

Türen sind von außen sowie von innen mit der Holzschutzlasur zu behandeln.

Ein regelmäßiger Anstrich gemäß der Herstellerangaben der Holzschutzlasur ist zum Schutz des Holzes notwendig.

## Werkzeug

Folgendes Werkzeug sollten Sie vor Beginn des Aufbaus zurechtgelegt haben:

Wasserwaage



Rollmaß

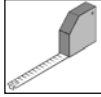

Bohrmaschine

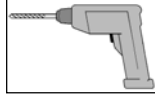

Elektroschrauber

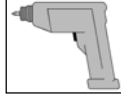

Feinsäge /  
Handkreissäge

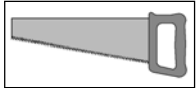

Universalmesser

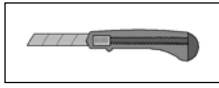

Schnur

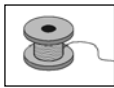

Hammer



- en -

## Dear customer

Read these instructions through completely before assembling your product in order to avoid errors in assembly or damage.

### IMPORTANT

**Please use the enclosed packing list to check immediately that your Engine house has been delivered complete and intact.**

Please do not dispose of the packing list before the guarantee period has expired. This list enables you to check that all the individual parts are present. It should be retained along with the proof of purchase. Any complaints which may arise can probably be easily rectified with this list.

We recommend that 2 people carry out the assembly.

In order to prevent accidents, we recommend that children are kept out of the direct vicinity during assembly.

We reserve the right to make further technological developments. This means that there may be minor deviations in the illustrations.

Please do not simply throw away the packaging material. Paper, card and corrugated board as well as plastic packaging materials should be placed in the correct collection containers.

## Recommendations

A prerequisite for successful assembly is an absolutely level and square foundation. We recommend a continuous foundation.

**A foundation plan can be obtained from your specialist dealer.**

A raft foundation is also possible.

In order to avoid rising damp, we recommend that a barrier layer using the packaging film, roofing paper or similar be laid between the foundation and the floor beams.

Roofing paper for a barrier layer is not included in the scope of this delivery.

Fit the wall boards together, with the tongue pointing upwards. If necessary, use a rubber mallet, where the assembly timber will prevent any damage to the tongue. The assembly timber can be found in the front wall package.

The structure should be anchored to the foundation to protect against wind damage. Concrete anchors or steel angles obtainable from specialist suppliers are suitable for anchoring the floor beams to the foundation. The anchors are not included in the scope of this delivery.

Please drill pilot holes for all screw connections to avoid damaging the wood. The following symbol in the instructions will indicate when this is necessary:

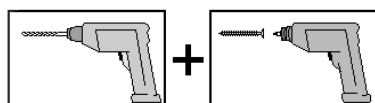

## Wood protection

Before and during assembly, protect untreated wood from direct sunlight or moisture.

The product is made from natural timber, for which regular and adequate wood preservation measures are obligatory. Please contact a wood preservation expert for information on professional preservation measures.

Wood preservation is to be carried out by the customer at his own risk. No guarantee can be given in the event of wood preservation not carried out in accordance with the instructions. Please also note the provisions relating to this in our guarantee. We wish you much pleasure with your wood product.

Doors and windows are to be treated both inside and outside with the wood protection agent.

The floor beams have already been adequately treated by us (boiler pressure impregnated).

A regular coating in accordance with the manufacturer's instructions of the wood protection agent is necessary to protect the wood.

## Tools

You should have the following tools to hand before beginning assembly.

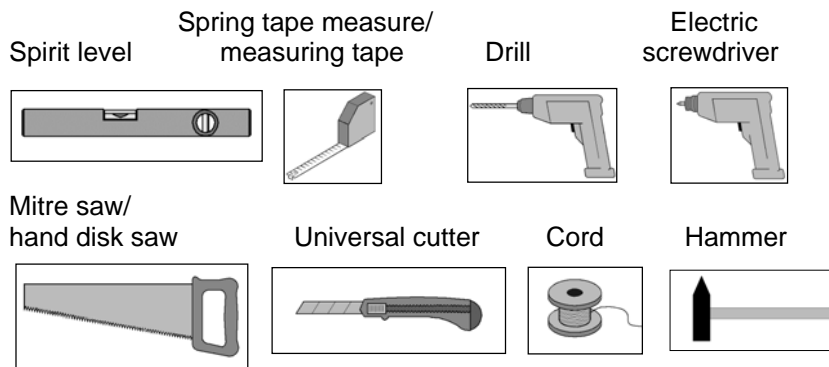

- fr -

## Chère Cliente, cher Client

Lisez entièrement la présente notice avant de procéder à l'assemblage afin d'éviter les erreurs et les dommages.

### IMPORTANT !

**Veillez vérifier immédiatement, à l'aide de la liste des pièces, si le remise est arrivé complet et en bon état.**

Ne détruisez la liste des pièces qu'une fois la garantie écoulee. Cette liste vous permet de vérifier si les pièces détachées sont complètes et doit être conservée avec le justificatif d'achat. Elle vous permettra de faire valoir aisément d'éventuelles réclamations.

Nous vous recommandons d'effectuer le montage à 2 personnes.

Afin de prévenir tout accident, éviter la présence d'enfants à proximité durant le montage.

Nous nous réservons le droit d'apporter aux produits des modifications dans le cadre de l'évolution technique. De légères différences sont par conséquent possibles par rapport aux illustrations.

Ne pas jeter simplement le matériel d'emballage! Les emballages en papier, carton et carton ondulé doivent être déposés dans le container de tri correspondant.

## Recommandations

Une fondation parfaitement plane et d'équerre est indispensable pour un montage dans les règles. Nous recommandons une fondation sur semelle.

**Un plan de fondation vous sera remis par votre revendeur!**

Une fondation en table est également possible.

Afin d'éviter les remontées d'humidité, nous recommandons de placer entre la fondation et les solives une couche composée du film d'emballage, de carton bitumé ou autre.

La couche d'arrêt en carton bitumé n'est pas fournie.

L'espacement des solives assure la nécessaire circulation de l'air sous la maison.

Afin de prévenir les dommages dus au vent, ancrer l'abri sur la fondation en fixant les solives à la fondation avec des pièces d'ancrage pour béton ou des équerres en acier du commerce.

Les pièces d'ancrage ne sont pas fournies.

Pré-percez tous les assemblages vissés afin d'éviter d'endommager les éléments en bois!

Ceci vous est rappelé par le symbole suivant dans la notice:

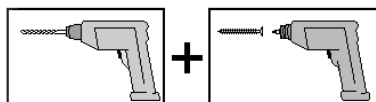

## Protection du bois

Protégez le bois non traité du soleil et de l'humidité avant et durant le montage!

Cet article est en bois brut naturel. Il est impératif d'entretenir et de protéger le bois régulièrement. Veuillez vous renseigner auprès d'un spécialiste du bois pour connaître les traitements appropriés.

Les mesures de protection du bois sont à effectuer par le client, sous sa propre responsabilité. Aucune garantie ne peut être accordée si le bois n'a pas été protégé selon les règles. Veuillez également vous reporter aux dispositions correspondantes de nos déclarations de garantie.

Nous vous souhaitons beaucoup de plaisir à l'usage de votre article en bois.

Traiter l'extérieur et l'intérieur de la porte et de la fenêtre avec la lasure protectrice.

Les solives sont déjà traitées d'origine (traitement en autoclave).

La lasure protectrice doit être appliquée de manière régulière conformément aux instructions du fabricant pour assurer la protection du bois.

## Outils

Pour le montage, nous vous recommandons de préparer les outils suivants.

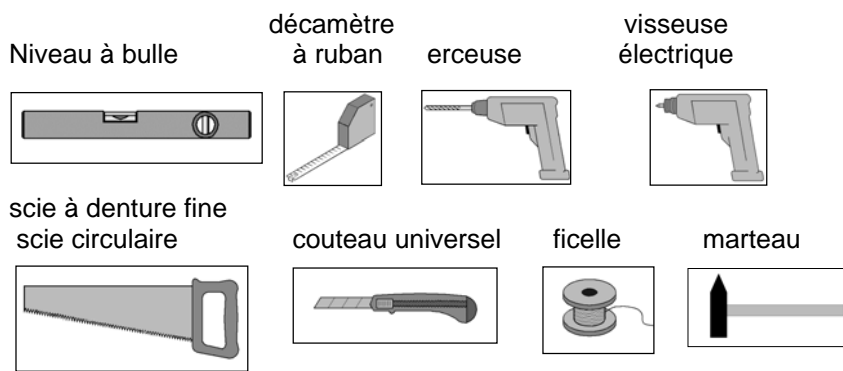

- it -

## Egredi clienti,

Prima del montaggio leggete con cura le presenti istruzioni al fine di evitare errori di montaggio o danni.

### **IMPORTANTE !**

**Controllate subito con l'ausilio della lista di imballaggio che il baracca attrezzata sia stata fornita completa e senza danni.**

Vi preghiamo di conservare la lista di imballaggio solo alla scadenza del periodo di garanzia. Questa lista serve per controllare la completezza della fornitura e deve essere conservata insieme allo scontrino. Con l'ausilio della lista è possibile risolvere eventuali reclami.

Raccomandiamo di eseguire il montaggio in 2 persone.

Per scongiurare eventuali incidenti tenere lontano i bambini dal luogo di montaggio.

Ci riserviamo di apportare modifiche ai fini del progresso tecnologico. Per tale motivo è possibile che nelle rappresentazioni vengano a crearsi lievi differenze.

Non gettare via il materiale di imballaggio! La carta, il cartone normale e ondulato cosiccome gli imballaggi in plastica devono essere smaltiti negli appositi contenitori di raccolta.

## Raccomandazioni

Per un corretto montaggio è assolutamente necessario che le fondamenta siano piane e perpendicolari. Raccomandiamo un fondamento a striscia.

**Per uno schema delle fondamenta rivolgetevi al vostro rivenditore specializzato!**

È possibile però anche utilizzare un fondamento a piastre.

Per evitare la salita di umidità raccomandiamo di posare uno strato di sbarramento in plastica, in cartone catramato etc. fra le fondamenta e le traverse del pavimento. Lo strato di sbarramento in cartone catramato non è contenuto nella fornitura.

Gli interstizi fra le travi di pavimento garantiscono la necessaria ventilazione della casetta.

Per evitare danni in caso di tempesta o forte vento la casa deve essere ancorata alle fondamenta. A tal fine è sufficiente utilizzare i comuni elementi di ancoraggio da calcestruzzo o angolari in acciaio con cui fissare le traverse del pavimento alle fondamenta. L'ancoraggio non è compreso nella fornitura.

Per evitare danni agli elementi in legno si raccomanda di preforare tutti i punti di avvitaggio a vite! Il presente simbolo richiama la vostra attenzione su tale particolare nel corso delle istruzioni:

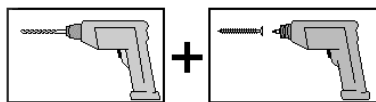

## Protezione legno

Proteggete il legno non trattato o naturale prima e durante il montaggio dai raggi solari diretti o dall'umidità! Il prodotto è composto dalla materia prima naturale del legno che rende le misure di protezione del legno assolutamente necessarie. Per il trattamento di protezione del legno a regola d'arte rivolgersi ad un esperto di protezione del legno.

Le misure di protezione del legno devono essere eseguite dal cliente sotto la sua responsabilità. Senza protezione del legno prescritta non può essere assunta nessuna garanzia. Osservare anche le disposizioni al riguardo nelle nostre dichiarazioni di garanzia.

Vi auguriamo un buon utilizzo del nostro prodotto legno.

Anche la porta e le finestre devono essere verniciate con la velatura sia internamente che esternamente. Le traverse del pavimento sono già sufficientemente pretrattate in fabbrica (impregnazione a pressione).

Per proteggere il legno è necessario stendere uno strato di velatura ad intervalli regolari come prescritto dal produttore.



## Utensile

Prima di iniziare con il montaggio tenere a portata di mano i seguenti utensili.

Livella ad acqua



metro  
a nastro

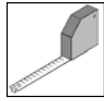

trapano

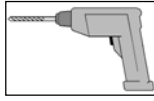

avvitatore  
elettrico



sega fine /  
sega circolare portatile

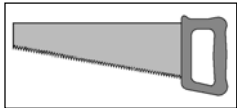

coltello universale

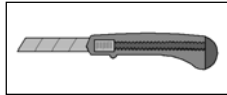

filo

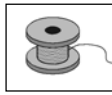



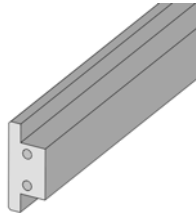
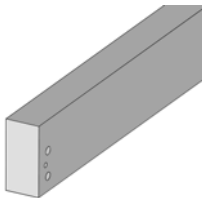
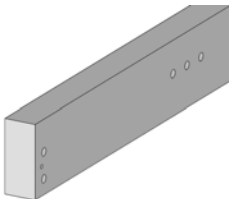
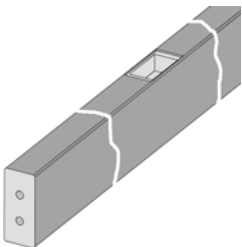
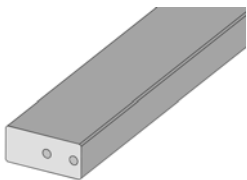
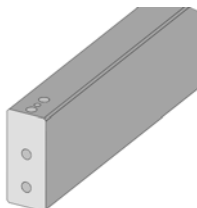

martello

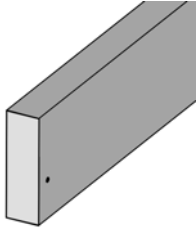
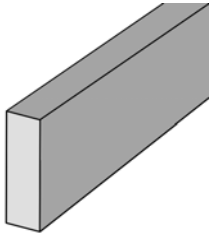
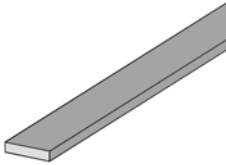
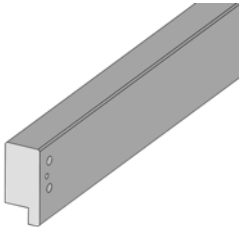
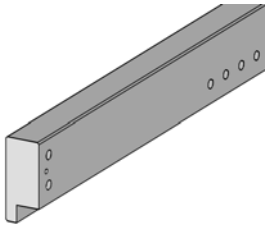
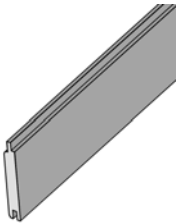

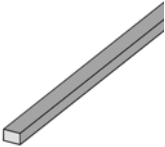
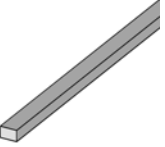
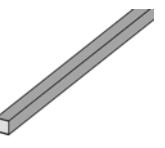
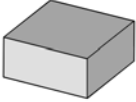
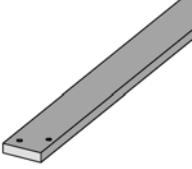
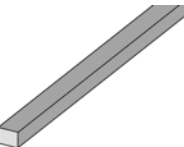

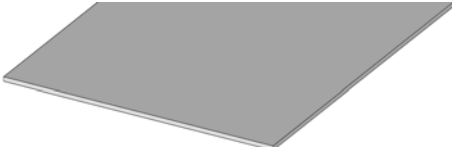

Pos	Bild	Art.-Nr.	Abmessung	Stück			
				415.2014.20000	415.2014.23000	415.2014.25000	415.2014.26000
3		G415.01.0005 G415.01.0805 G415.01.1105 G415.01.1205	40 / 90 / 1920	1	1	1	1
4L		G415.01.0006 G415.01.0806 G415.01.1106 G415.01.1206	40 / 90 / 2000	1	1	1	1
4R		G415.01.0007 G415.01.0807 G415.01.1107 G415.01.1207	40 / 90 / 2000	1	1	1	1
5		B415.02.0001 B415.02.0801 B415.02.1101 B415.02.1201	40 / 90 / 1920	1	1	1	1
6		G415.01.0008 G415.01.0808 G415.01.1108 G415.01.1208	40 / 90 / 1820	4	4	4	4
9		G415.01.0012 G415.01.0812 G415.01.1112 G415.01.1212	40 / 90 / 1170	4	4	4	4

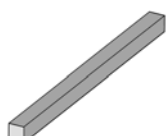
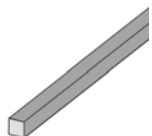



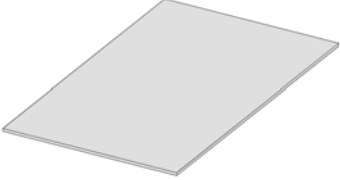
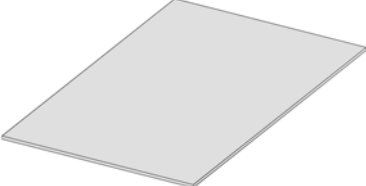

Pos	Bild	Art.-Nr.	Abmessung	Stück			
				415.2014.20000	415.2014.23000	415.2014.25000	415.2014.26000
10		G415.01.0028 G415.01.0828 G415.01.1128 G415.01.1228	40 / 84 / 2000	1	1	1	1
11		G415.01.0029 G415.01.0829 G415.01.1129 G415.01.1229	40 / 84 / 1210	4	4	4	4
13		G415.01.0030 G415.01.0830 G415.01.1130 G415.01.1230	19 / 96 / 2000	1	1	1	1
14L		G415.01.0045 G415.01.0845 G415.01.1145 G415.01.1245	40 / 90 / 2000	1	1	1	1
14R		G415.01.0046 G415.01.0846 G415.01.1146 G415.01.1246	40 / 90 / 2000	1	1	1	1
15		R002.0135.0896 R010.0135.0896	14 / 95 / 896	48	48	48	48

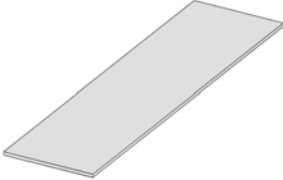
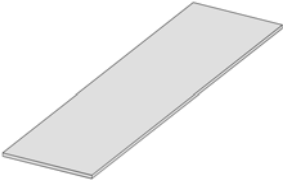
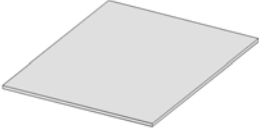
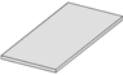
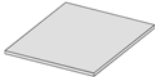
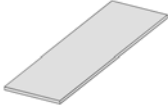
Pos	Bild	Art.-Nr.	Abmessung	Stück			
				415.2014.20000	415.2014.23000	415.2014.25000	415.2014.26000
16		G415.01.0018 G415.01.1018	13 / 20 / 865	4	4	4	4
17		G415.01.0019 G415.01.1019	13 / 20 / 1915	4	4	4	4
18		G415.01.0020 G415.01.1020	14 / 14 / 865	2	2	2	2
19	G415.06.0021 		40 / 90 / 90	6	6	6	6
21	G415.01.0023 		19 / 70 / 1580	2	2	2	2
25	G415.01.0025 		30 / 40 / 1170	1	1	1	1



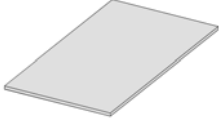



Pos	Bild	Art.-Nr.	Abmessung	Stück			
				415.2014.20000	415.2014.23000	415.2014.25000	415.2014.26000
26	G415.03.0023 		18 / 775 / 2248	2	2	2	2
27	G415.02.0003 		50 / 50 / 1550	2	2	2	2
29	G415.02.0001 		50 / 50 / 2250	1	1	1	1
30	G415.02.0005 		25 / 25 / 2250	1	1	1	1
31	R002.0190.0500 		30 / 30 / 500	6	6	6	6
32	R002.0190.1183 		30 / 30 / 1183	2	2	2	2





Pos	Bild	Art.-Nr.	Abmessung	Stück			
				415.2014.20000	415.2014.23000	415.2014.25000	415.2014.26000
33		B415.12.0001 B415.12.0801 B415.12.1101 B415.12.1201	884 x 1938	1	1	1	1
34		B415.12.0002 B415.12.0802 B415.12.1102 B415.12.1202	884 x 1938	1	1	1	1
35		B415.12.0003 B415.12.0803 B415.12.1103 B415.12.1203	599 x 1938	2	2	2	2
36		B415.12.0004 B415.12.0804 B415.12.1104 B415.12.1204	599 x 1938	2	2	2	2
37	G415.03.0002 		18 / 1170 / 1940	1	1	1	1
38	G415.03.0003 		18 / 1183 / 1902	1	1	1	1

Pos	Bild	Art.-Nr.	Abmessung	Stück			
				415.2014.20000	415.2014.23000	415.2014.25000	415.2014.26000
39	G415.03.0004 		18 / 500 / 1902	1	1	1	1
40	G415.03.0005 		18 / 500 / 1902	2	2	2	2
41	G415.03.0006 		18 / 1172 / 928	1	1	1	1
42	G415.03.0007 		18 / 730 / 335	1	1	1	1
43	G415.03.0009 		18 / 665 / 546	2	2	2	2
44	G415.03.0013 		18 / 343 / 1170	1	1	1	1

Pos	Bild	Art.-Nr.	Abmessung	Stück			
				415.2014.20000	415.2014.23000	415.2014.25000	415.2014.26000
45	G415.03.0010 		18 / 247 / 500	4	4	4	4
46	G415.03.0011 		18 / 500 / 555	3	3	3	3
47	G415.03.0012 		18 / 653 / 1170	2	2	2	2
50			5,0 x 140	10	10	10	10
51			5,0 x 100	24	24	24	24
52			4,0 x 70	32	32	32	32

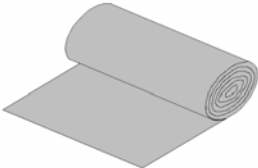

Pos	Bild	Art.-Nr.	Abmessung	Stück			
				415.2014.20000	415.2014.23000	415.2014.25000	415.2014.26000
53			3,0 x 40	108	108	108	108
54			3,0 x 35	112	112	112	112
55			3,0 x 35	54	54	54	54
56			3,0 x 16	58	58	58	58
57			3,0 x 25	200	200	200	200
58			2,0 x 35	50	50	50	50

Pos	Bild	Art.-Nr.	Abmessung	Stück			
				415.2014.20000	415.2014.23000	415.2014.25000	415.2014.26000
60			8,0 x 35	47	47	47	47
61				6	6	6	6
63				4	4	4	4
64				4	4	4	4
65				18	18	18	18
66	100.1040.05.00 		1,25m <sup>2</sup>	1	1	1	1

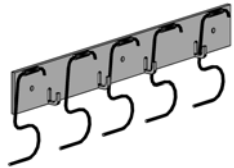
Pos	Bild	Art.-Nr.	Abmessung	Stück			
				415.2014.20000	415.2014.23000	415.2014.25000	415.2014.26000
67				4	4	4	4
68				1	1	1	1

1.

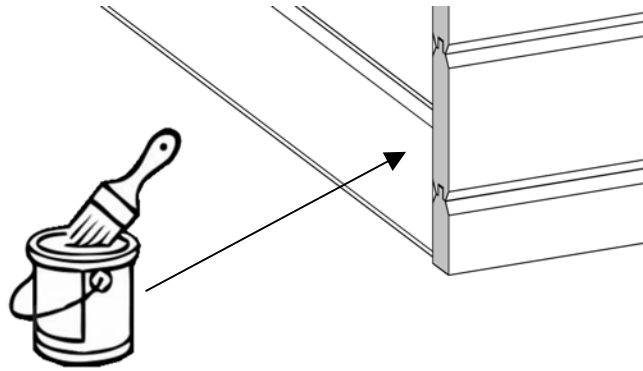

2.

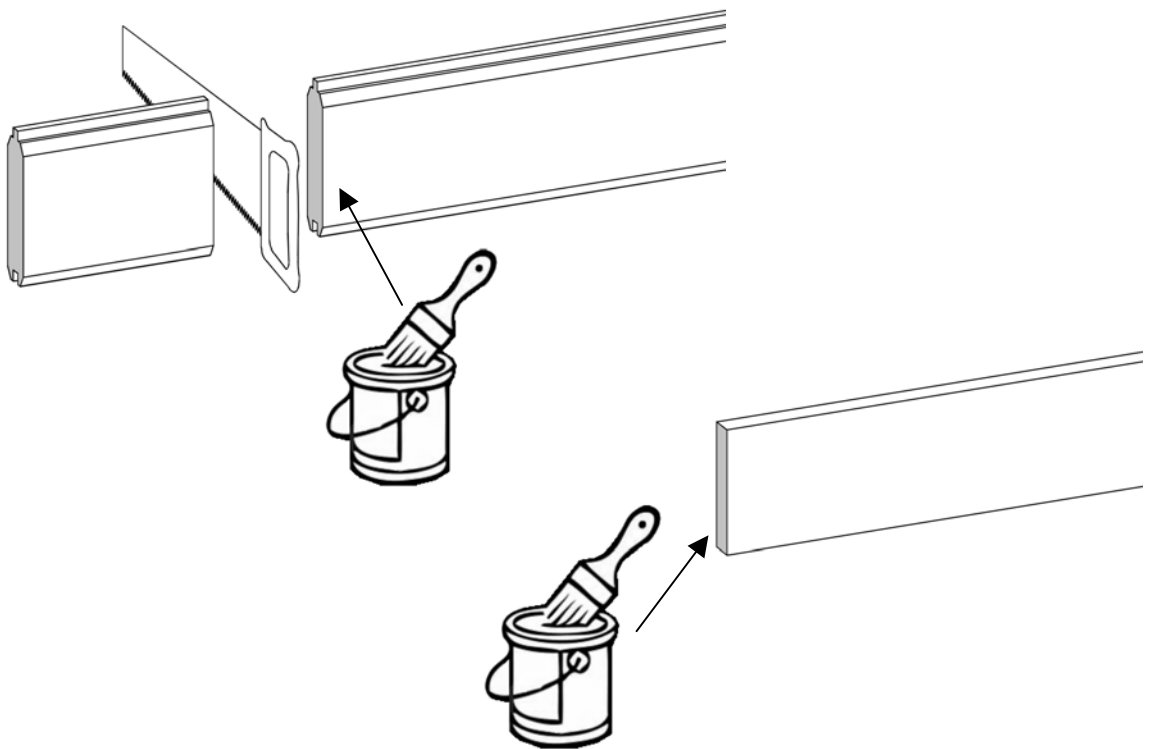

3.

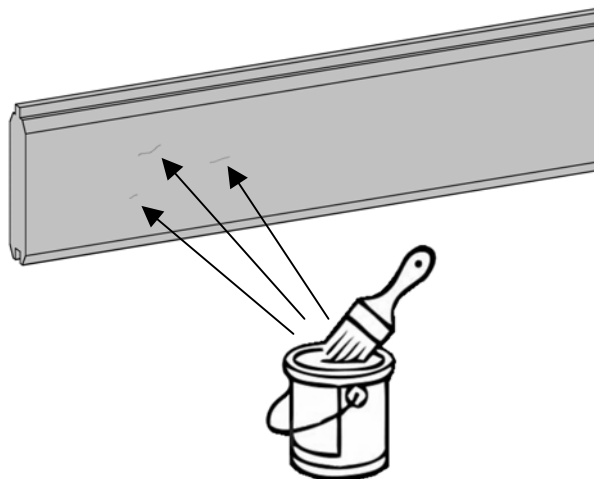

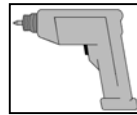
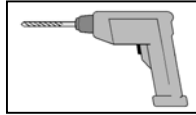
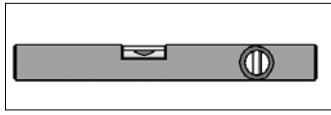
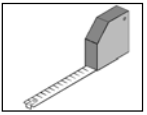

**1**

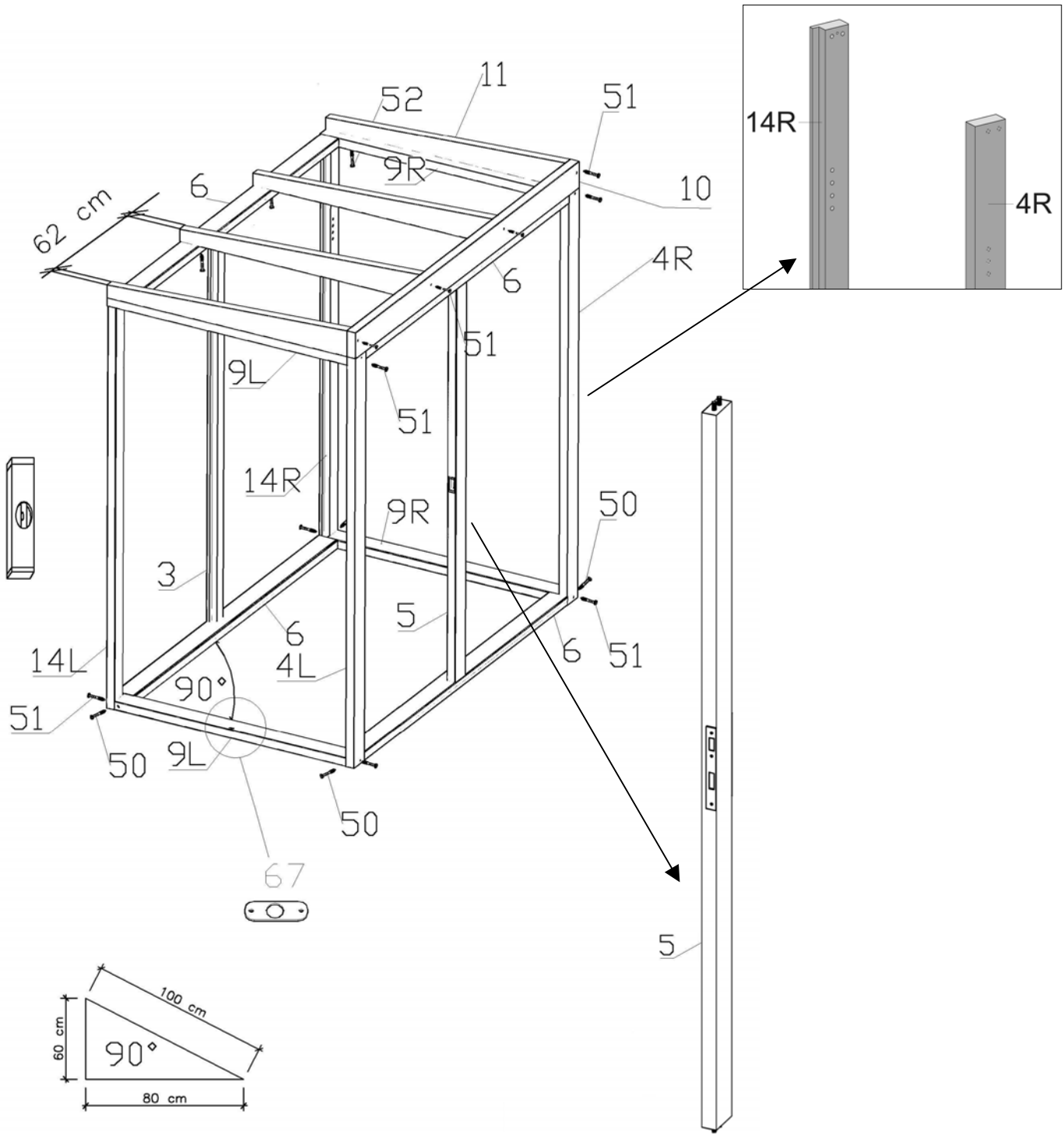

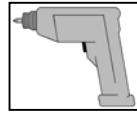
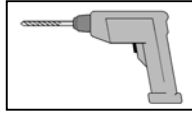
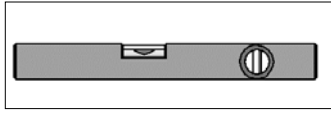
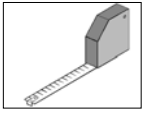

**2**

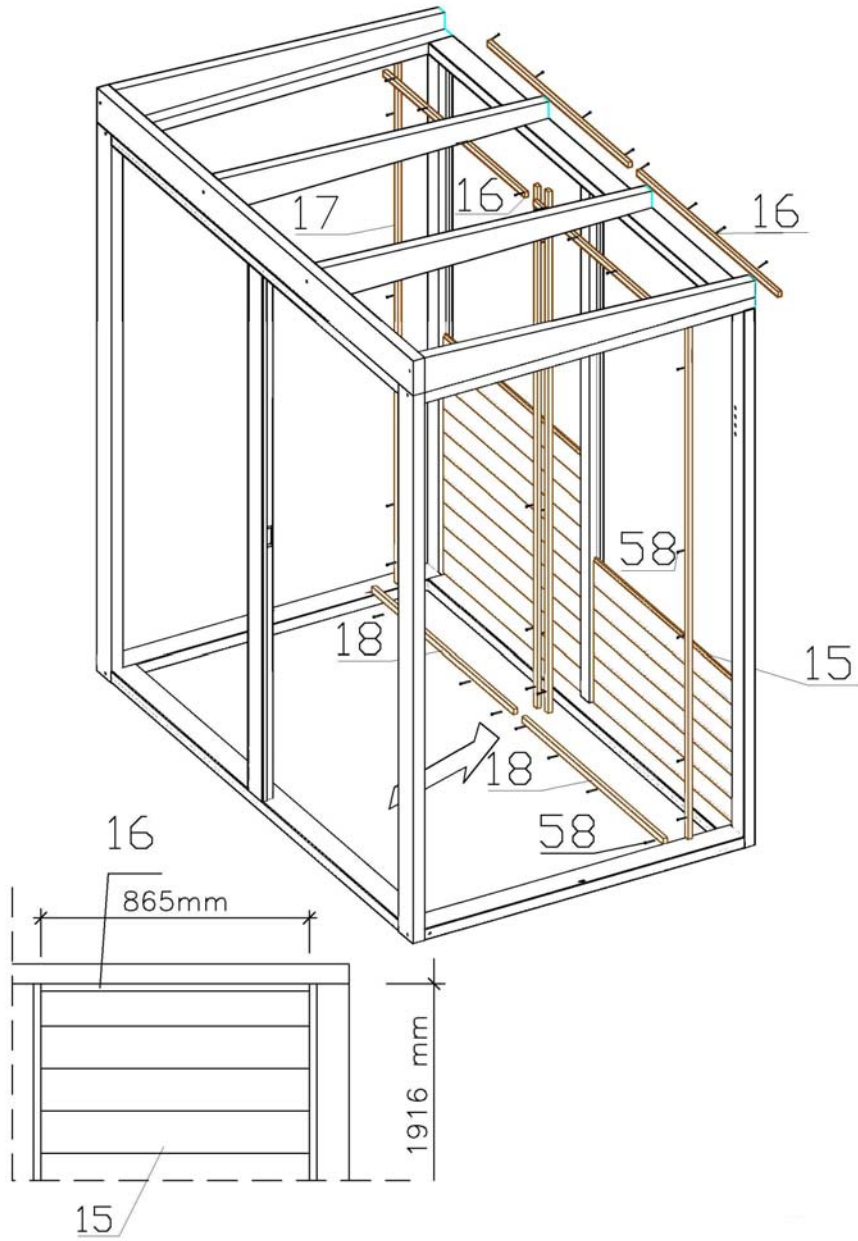

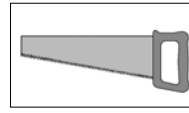
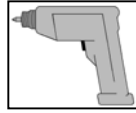
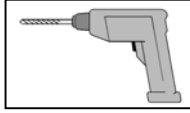
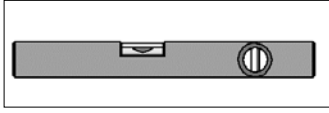
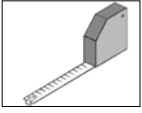

**3**

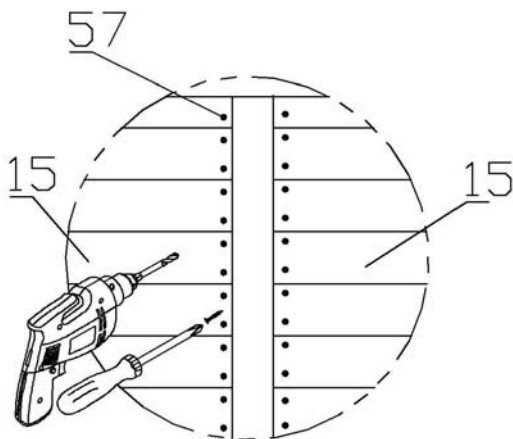
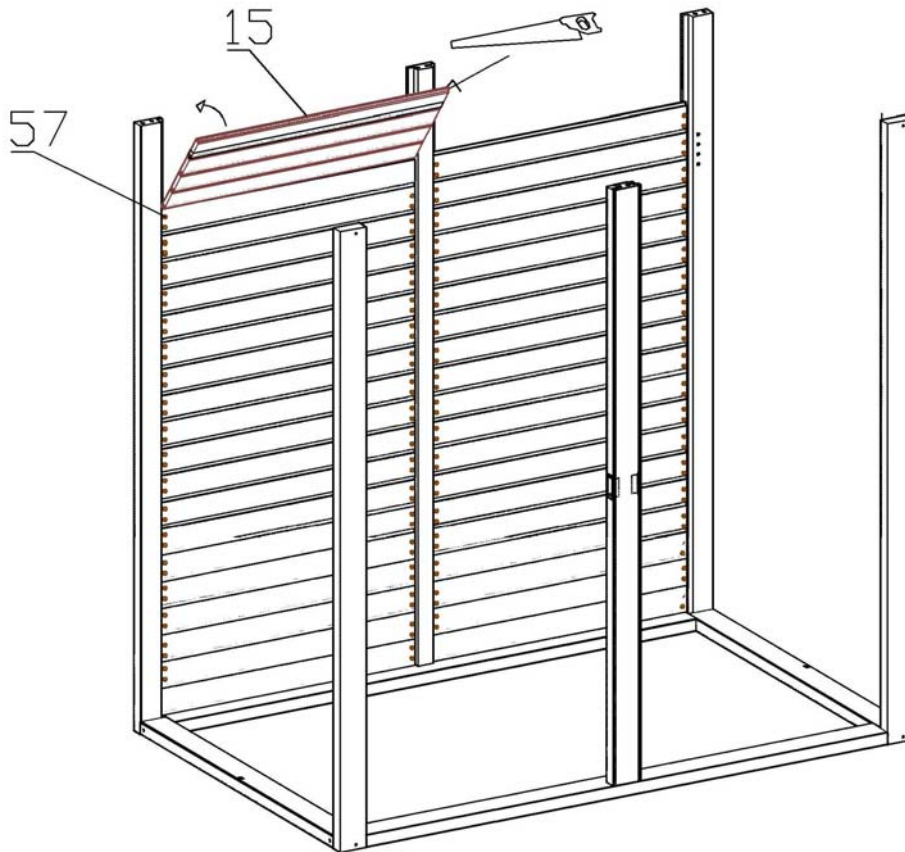

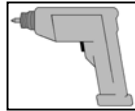
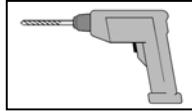
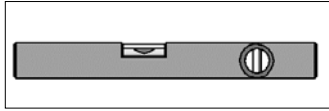
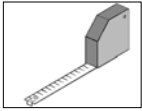

**4**

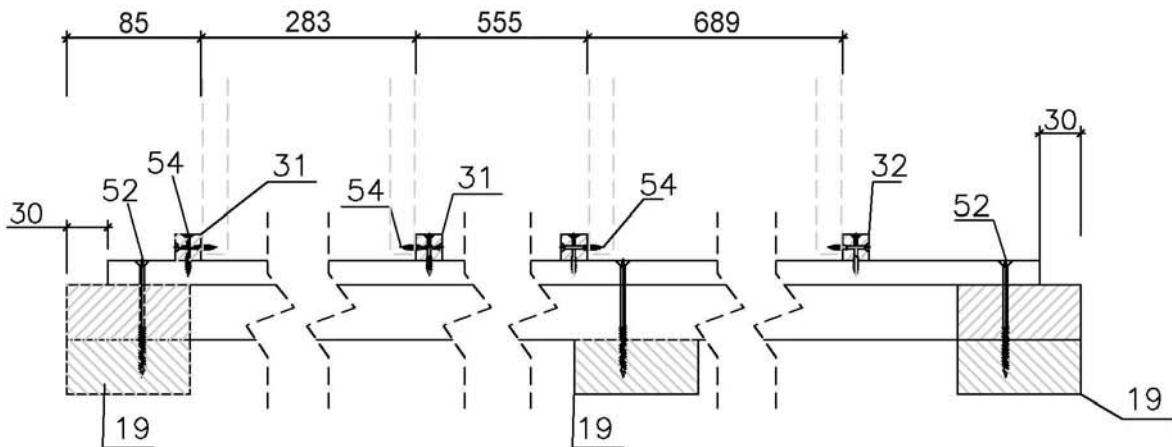
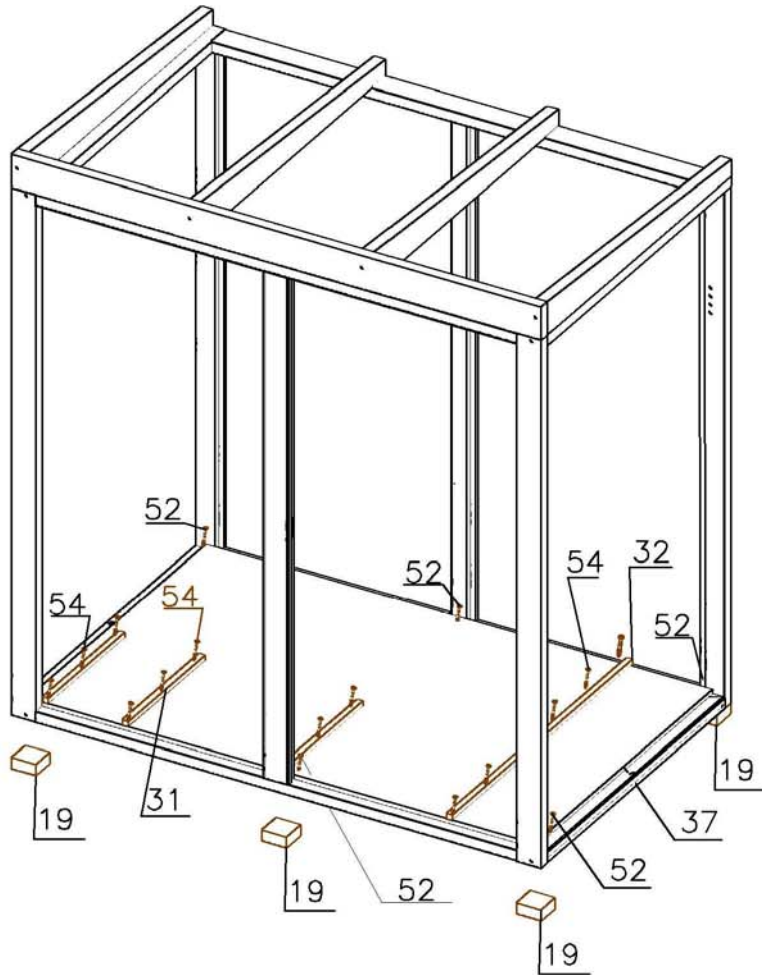



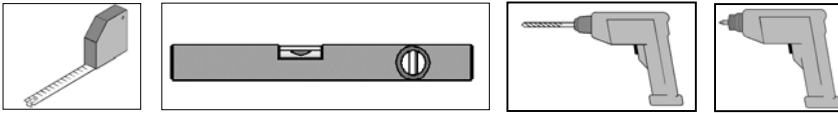

**5**

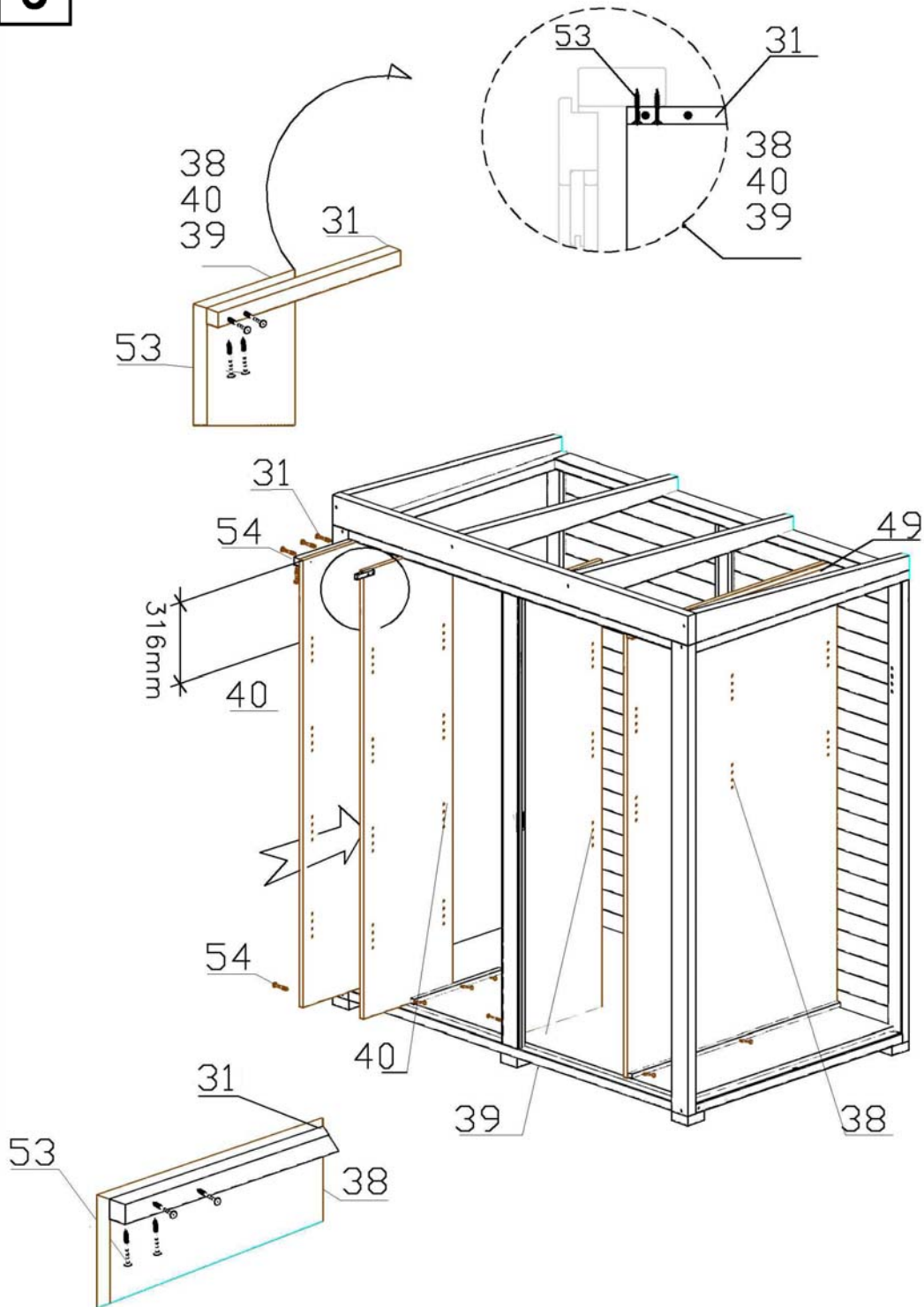

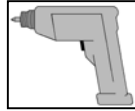
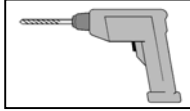
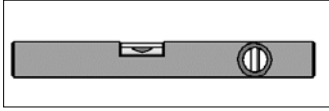
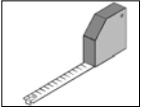

**6**

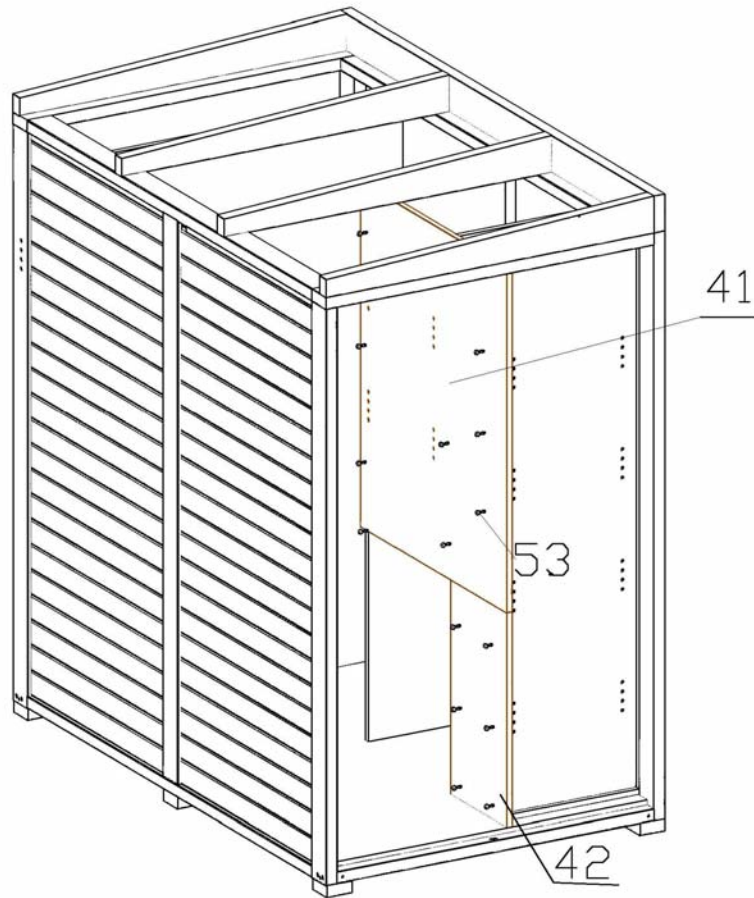

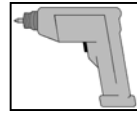
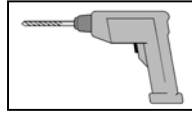
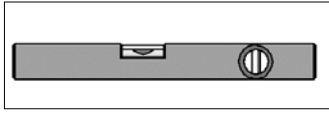
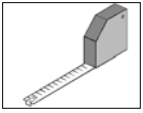

**7**

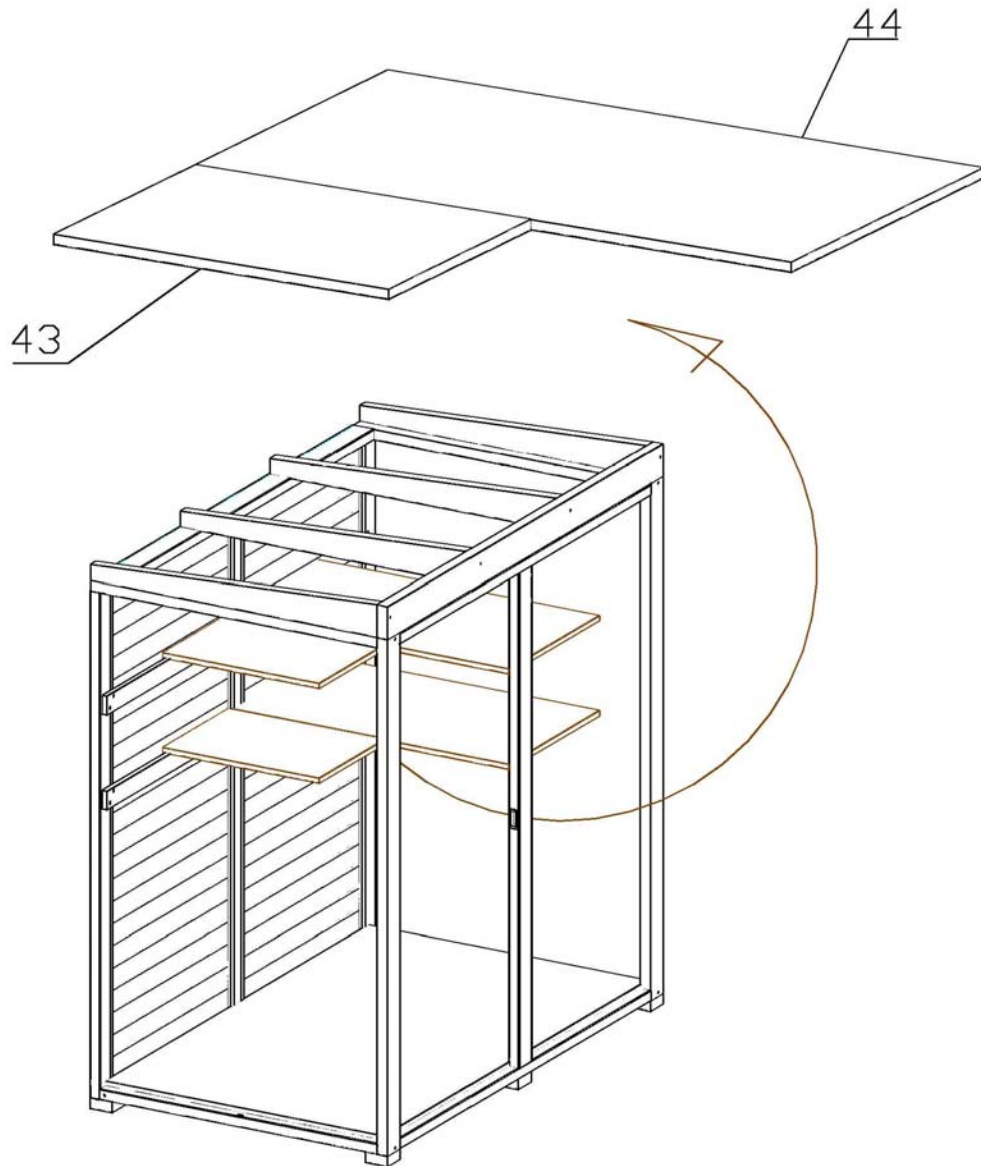

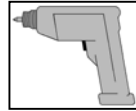
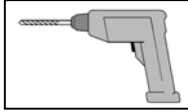
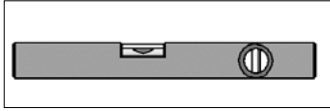
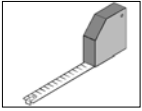

**8**

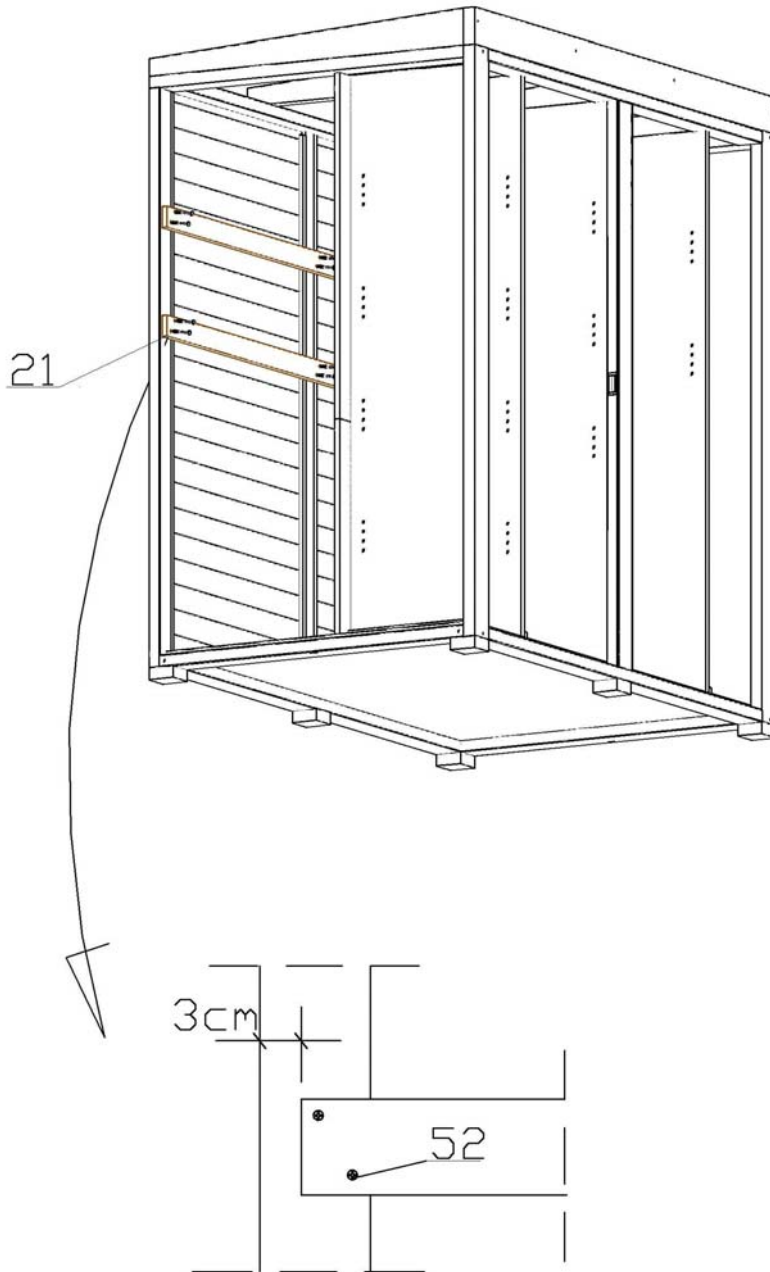

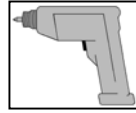
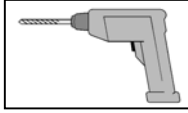
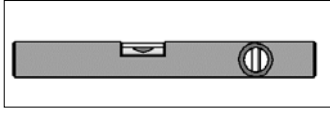
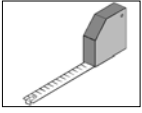

**9**

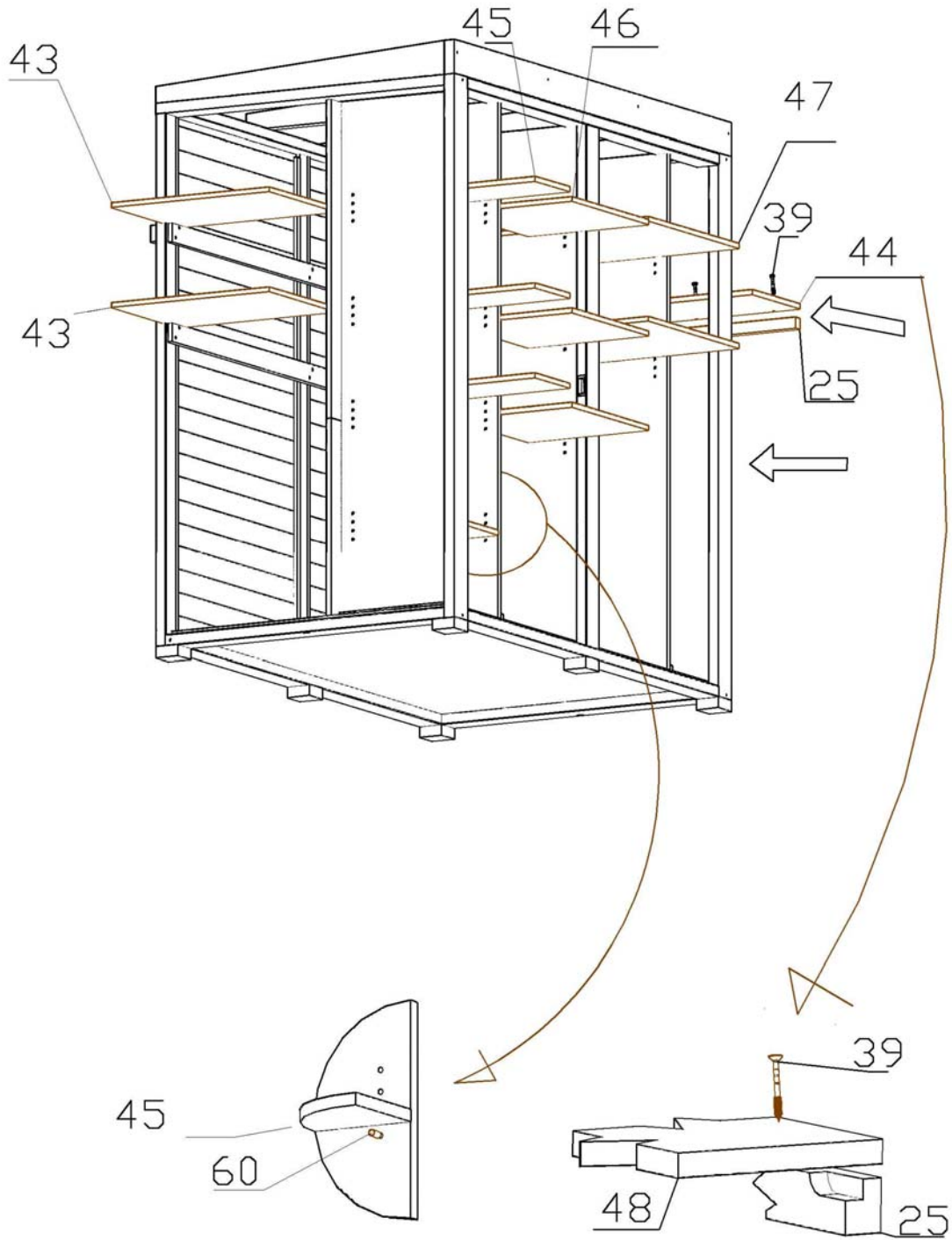

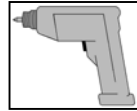
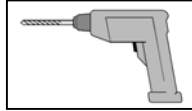
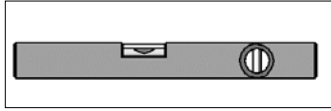
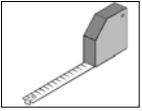

**10**

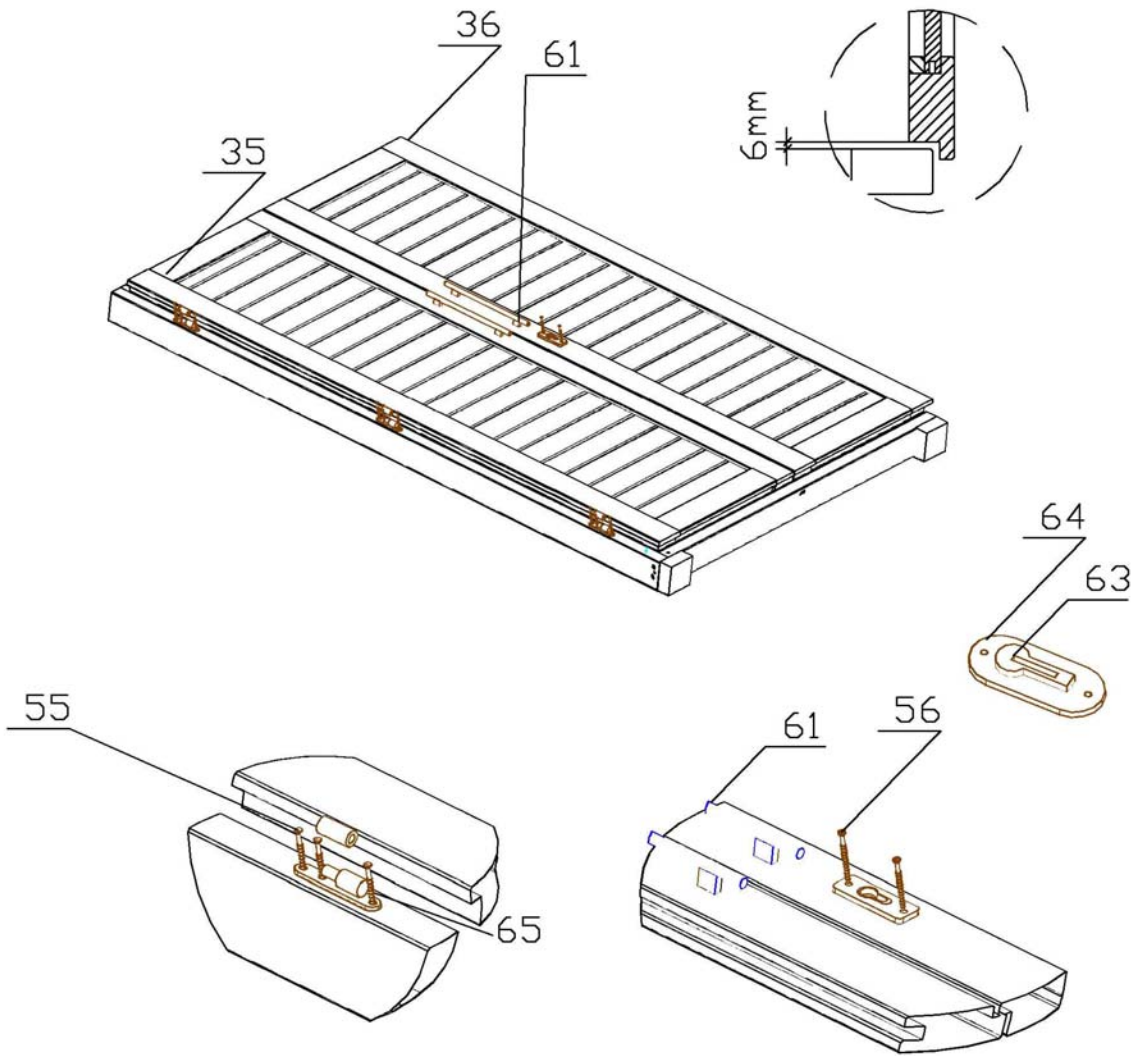

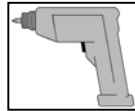
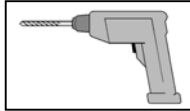
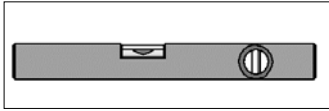
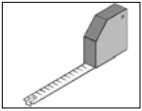

# 11

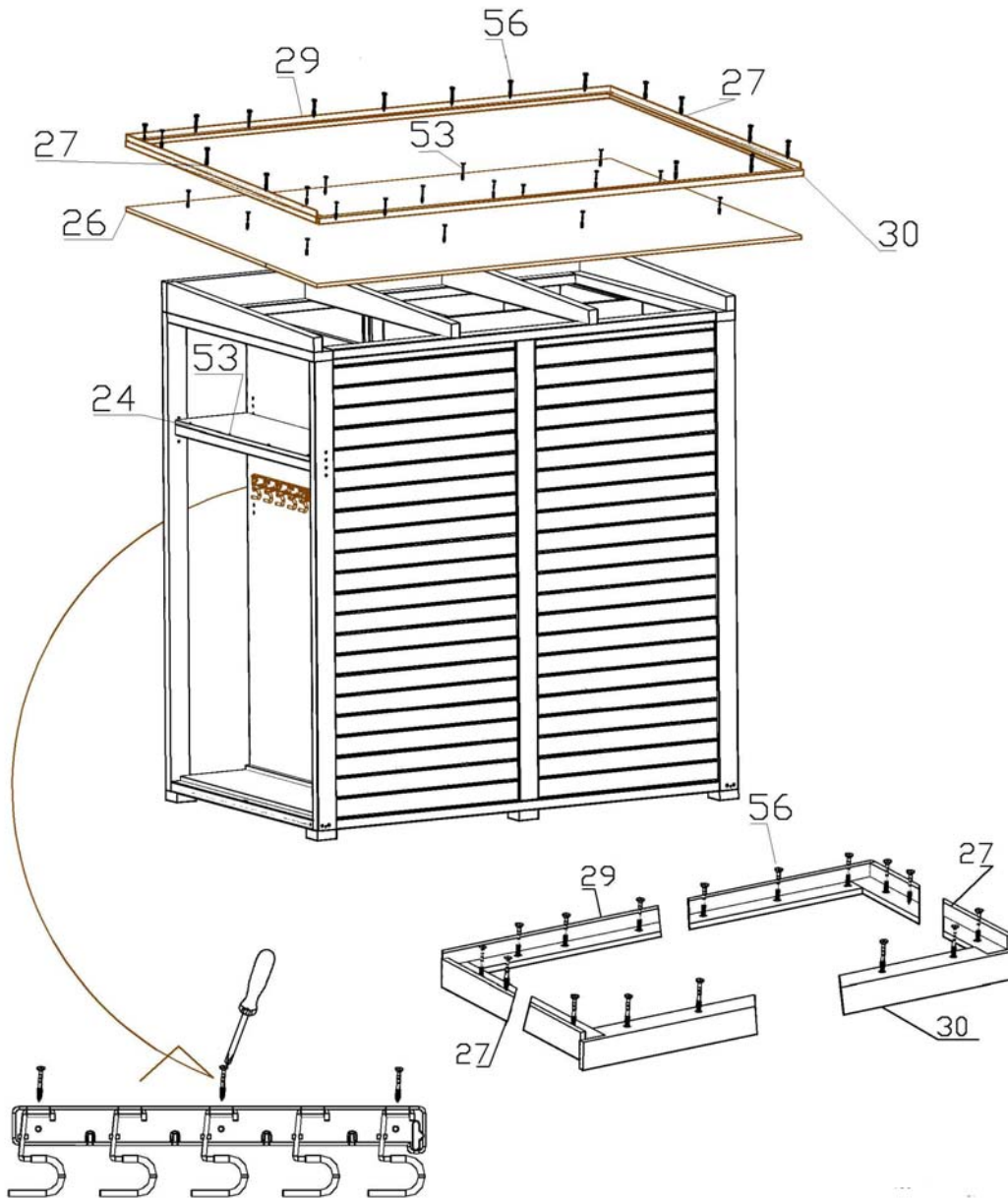

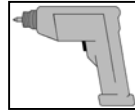
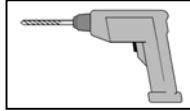
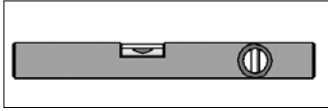
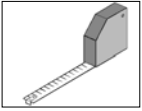

**12**

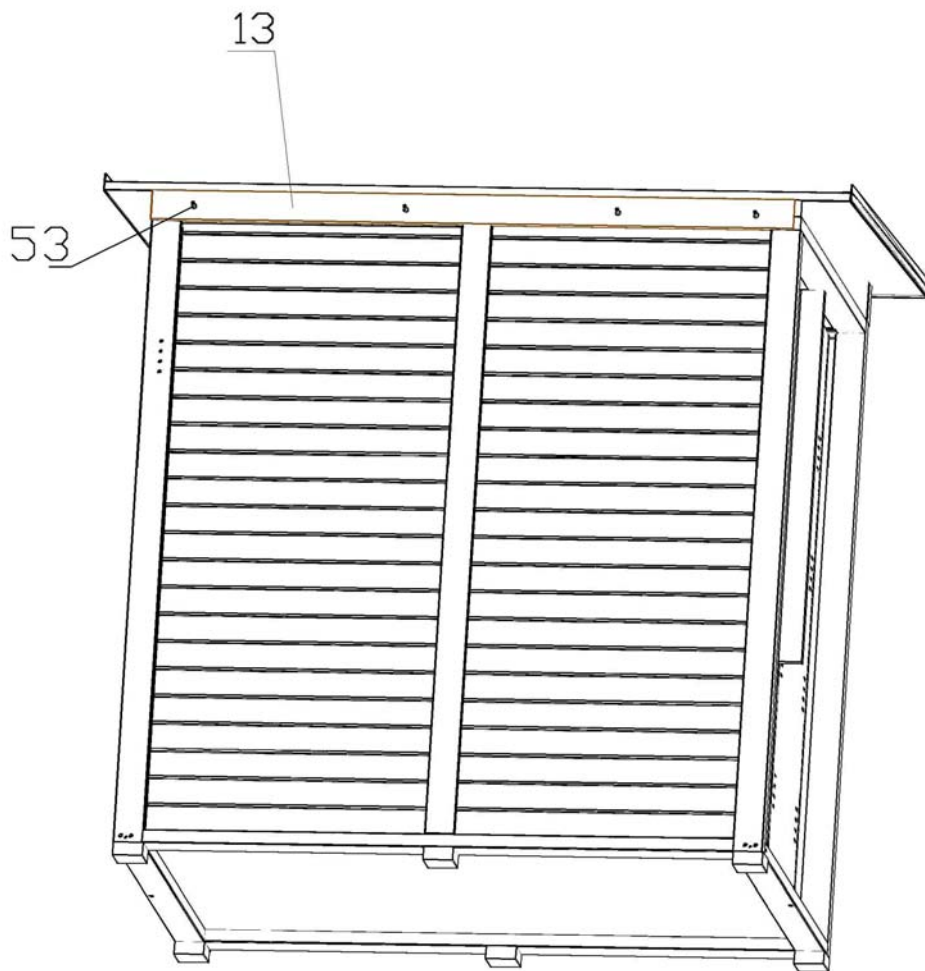



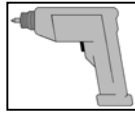
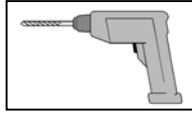
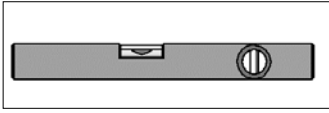
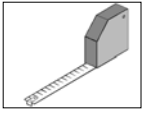

**13**

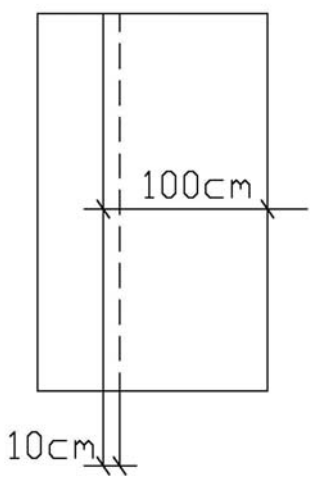
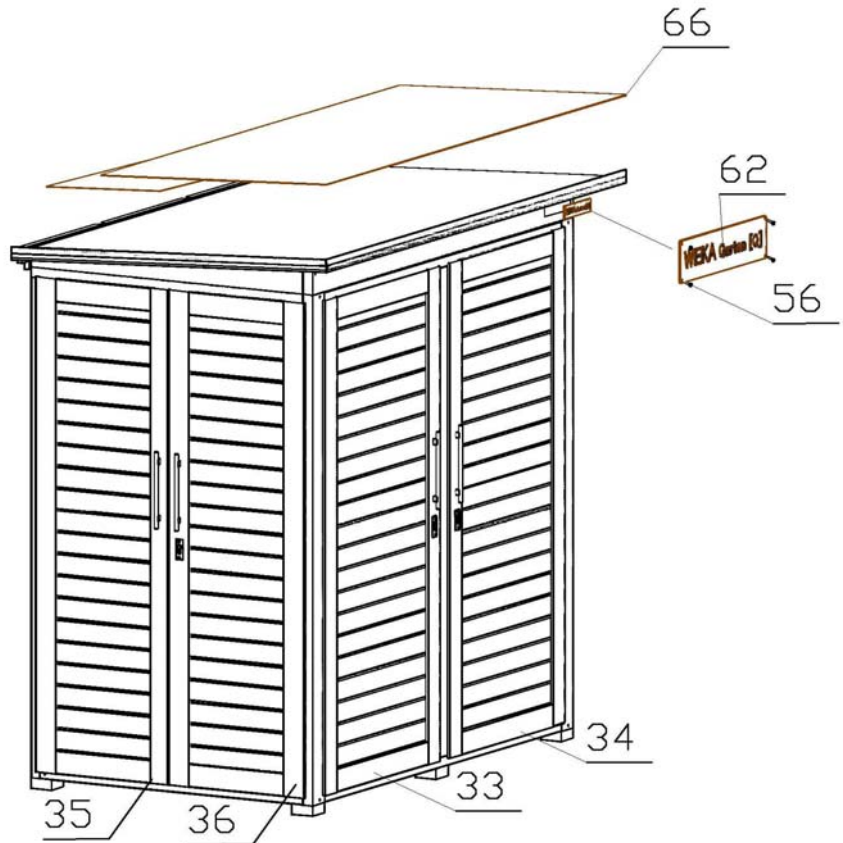

**WEKA Garten [Q]**







weka Holzbau GmbH,  
Johannesstr. 16  
D-17034 Neubrandenburg  
Tel.: 0395 42908-0  
Fax: 0395 42908-83  
EMail: [Info@weka-Holzbau.com](mailto:Info@weka-Holzbau.com)

**MA Art.-Nr.: 800.0286.17.16**