

4018211 200191

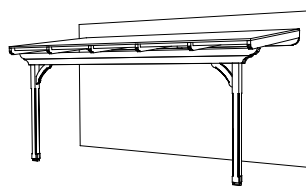

4018211 200252

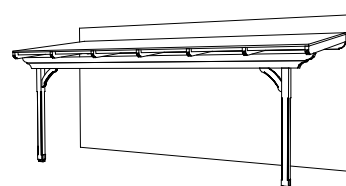

4018211 200313

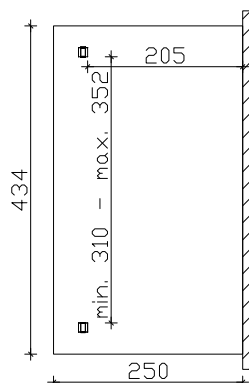

Grundriss

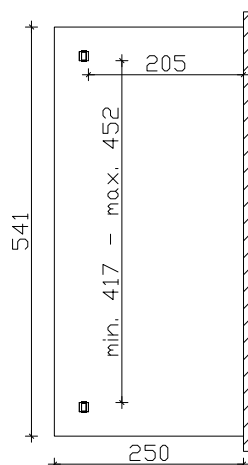

Grundriss

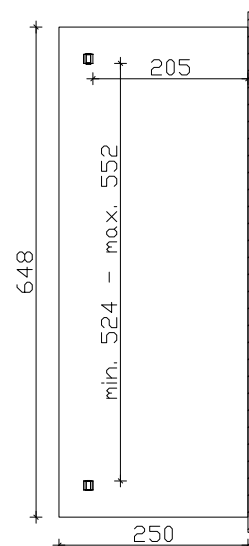

Grundriss

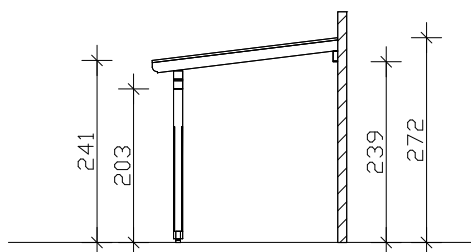

Seitenansicht

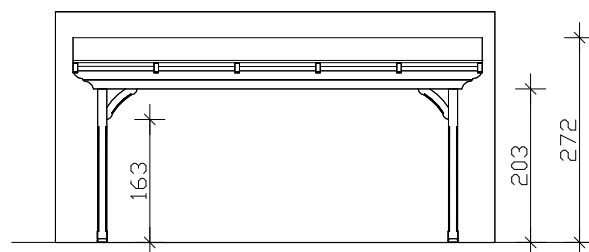

Frontansicht

M 1:100

## "Ravenna" Terrassenüberdachung 434cm / 541cm / 648cm x 250cm

### Datenblatt / Baubeschreibung

<b>Holzart / Eisenteile</b>	<b>Douglasie, unbehandelt / verzinkt</b>
<b>Pfosten</b>	<b>2 Stück 12x12x198cm</b>
<b>Dacheindeckung</b>	<b>Polycarbonat Doppelstegplatten 16mm (transparent)</b>
<b>Schneelast</b>	<b>sk = 2,00kN/m<sup>2</sup></b>
<b>Breite x Tiefe</b>	<b>434cm / 541cm / 648cm x 250cm</b>
<b>Gesamthöhe / Durchgang</b>	<b>241-272cm / 203cm (inkl. Abstand zum Boden, Aufschraubstütze = 5cm)</b>
<b>Fläche (umb.Raum)</b>	<b>10,85m<sup>2</sup> (27,83m<sup>3</sup>) / 13,53m<sup>2</sup> (34,70m<sup>3</sup>) / 16,20m<sup>2</sup> (41,55m<sup>3</sup>)</b>
<b>Dachneigung</b>	<b>7°</b>
<b>Verpackungseinheit</b>	<b>BxLxH 110x440-655x40-45cm / Gewicht 260/305/355kg</b>
<b>Inklusive</b>	<b>Montagematerial, Aufschraubstützen, Kopfbänder, Aufbauanleitung</b> (ohne Dübel für Wandbefestigung, ohne Wandabdichtungsprofile)

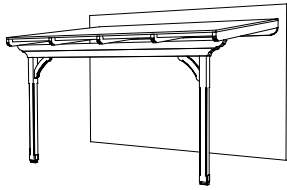

4018211 200214

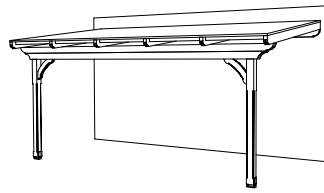

4018211 200276

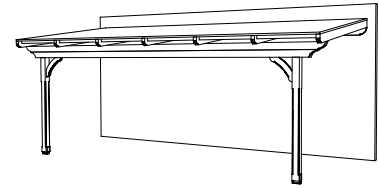

4018211 200337

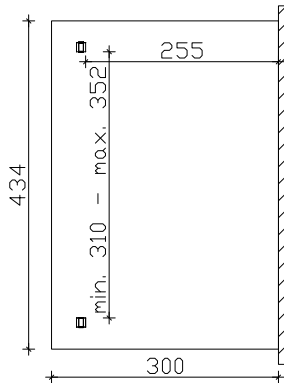

Grundriss

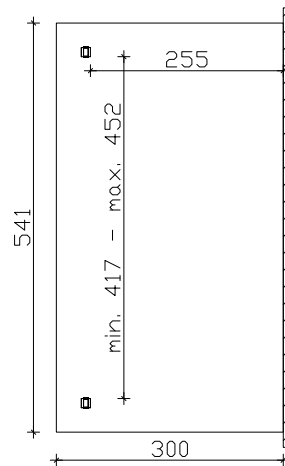

Grundriss

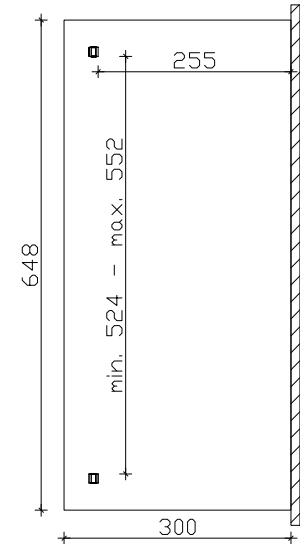

Grundriss

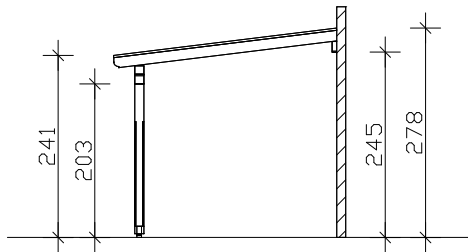

Seitenansicht

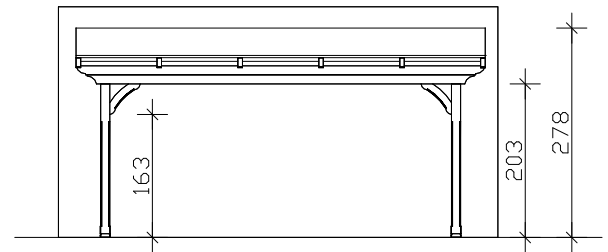

Frontansicht

M 1:100

## "Ravenna" Terrassenüberdachung 434cm / 541cm / 648cm x 300cm

### Datenblatt / Baubeschreibung

<b>Holzart / Eisenteile</b>	<b>Douglasie, unbehandelt / verzinkt</b>
<b>Pfosten</b>	<b>2 Stück 12x12x198cm</b>
<b>Dacheindeckung</b>	<b>Polycarbonat Doppelstegplatten 16mm (transparent)</b>
<b>Schneelast</b>	<b>sk = 2,00kN/m<sup>2</sup></b>
<b>Breite x Tiefe</b>	<b>434cm / 541cm / 648cm x 300cm</b>
<b>Gesamthöhe / Durchgang</b>	<b>241-278cm / 203cm (inkl. Abstand zum Boden, Aufschraubstütze = 5cm)</b>
<b>Fläche (umb.Raum)</b>	<b>13,02m<sup>2</sup> (33,79m<sup>3</sup>) / 16,23m<sup>2</sup> (42,12m<sup>3</sup>) / 19,44m<sup>2</sup> (50,45m<sup>3</sup>)</b>
<b>Dachneigung</b>	<b>7°</b>
<b>Verpackungseinheit</b>	<b>BxLxH 110x440-655x40-45cm / Gewicht 280/330/380kg</b>
<b>Inklusive</b>	<b>Montagematerial, Aufschraubstützen, Kopfbänder, Aufbauanleitung</b> (ohne Dübel für Wandbefestigung, ohne Wandabdichtungsprofile)

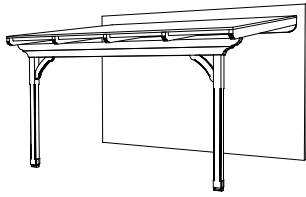

4018211 200238

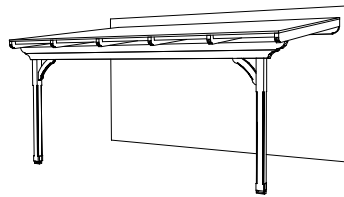

4018211 200290

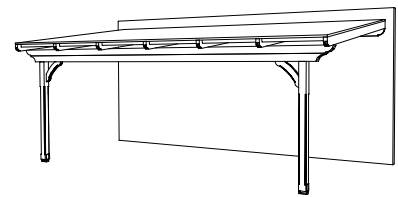

4018211 200351

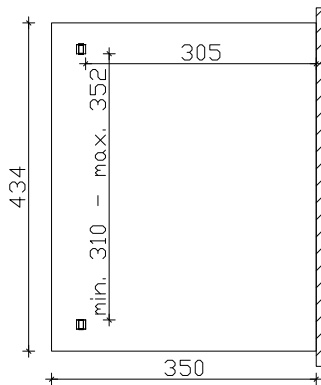

Grundriss

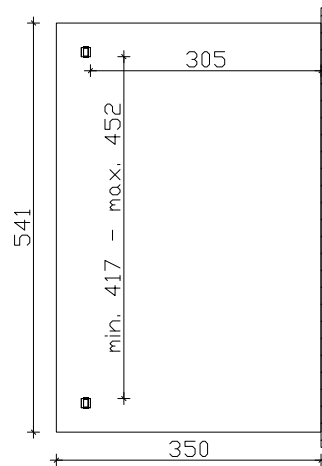

Grundriss

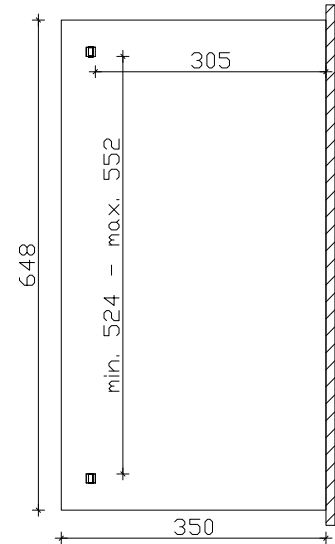

Grundriss

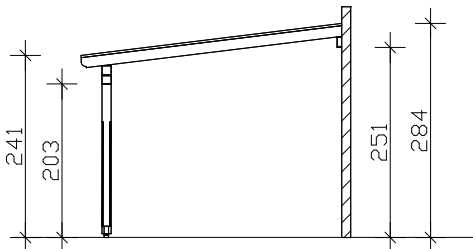

Seitenansicht

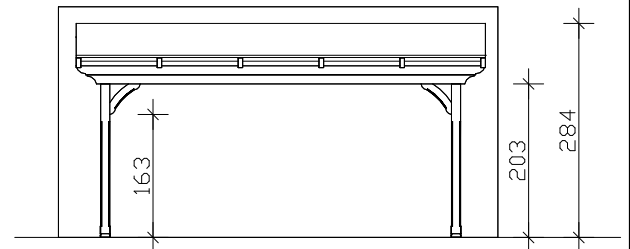

Frontansicht

M 1:100

## "Ravenna" Terrassenüberdachung 434cm / 541cm / 648cm x 350cm

### Datenblatt / Baubeschreibung

<b>Holzart / Eisenteile</b>	<b>Douglasie, unbehandelt / verzinkt</b>
<b>Pfosten</b>	<b>2 Stück 12x12x198cm</b>
<b>Dacheindeckung</b>	<b>Polycarbonat Doppelstegplatten 16mm (transparent)</b>
<b>Schneelast</b>	<b>sk = 1,75kN/m<sup>2</sup></b>
<b>Breite x Tiefe</b>	<b>434cm / 541cm / 648cm x 350cm</b>
<b>Gesamthöhe / Durchgang</b>	<b>241-284cm / 203cm (inkl. Abstand zum Boden, Aufschraubstütze = 5cm)</b>
<b>Fläche (umb.Raum)</b>	<b>15,19m<sup>2</sup> (39,87m<sup>3</sup>) / 18,94m<sup>2</sup> (49,71m<sup>3</sup>) / 22,68m<sup>2</sup> (59,54m<sup>3</sup>)</b>
<b>Dachneigung</b>	<b>7°</b>
<b>Verpackungseinheit</b>	<b>BxLxH 110x450-655x38-46cm / Gewicht 300/355/410kg</b>
<b>Inklusive</b>	<b>Montagematerial, Aufschraubstützen, Kopfbänder, Aufbauanleitung</b> (ohne Dübel für Wandbefestigung, ohne Wandabdichtungsprofile)