

Technische Daten

Rotterdam Modern



Kontrolliert durch:

Achtung: Alle angegebenen Maße sind ca.-Maße!

3D-Darstellung Rotterdam Modern

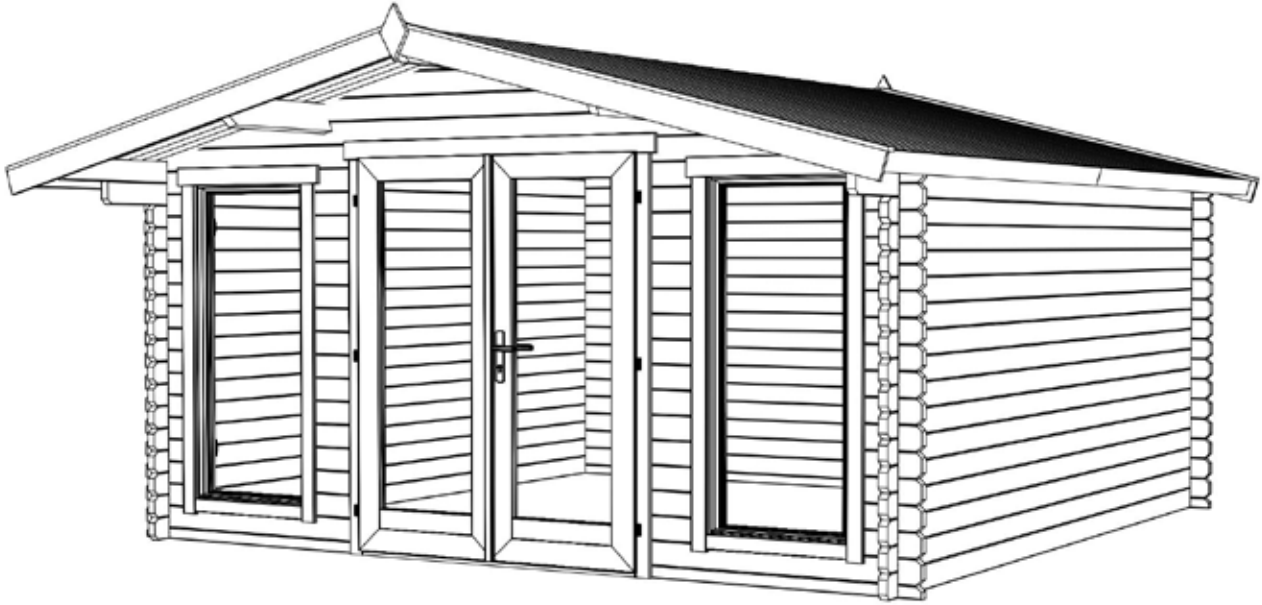



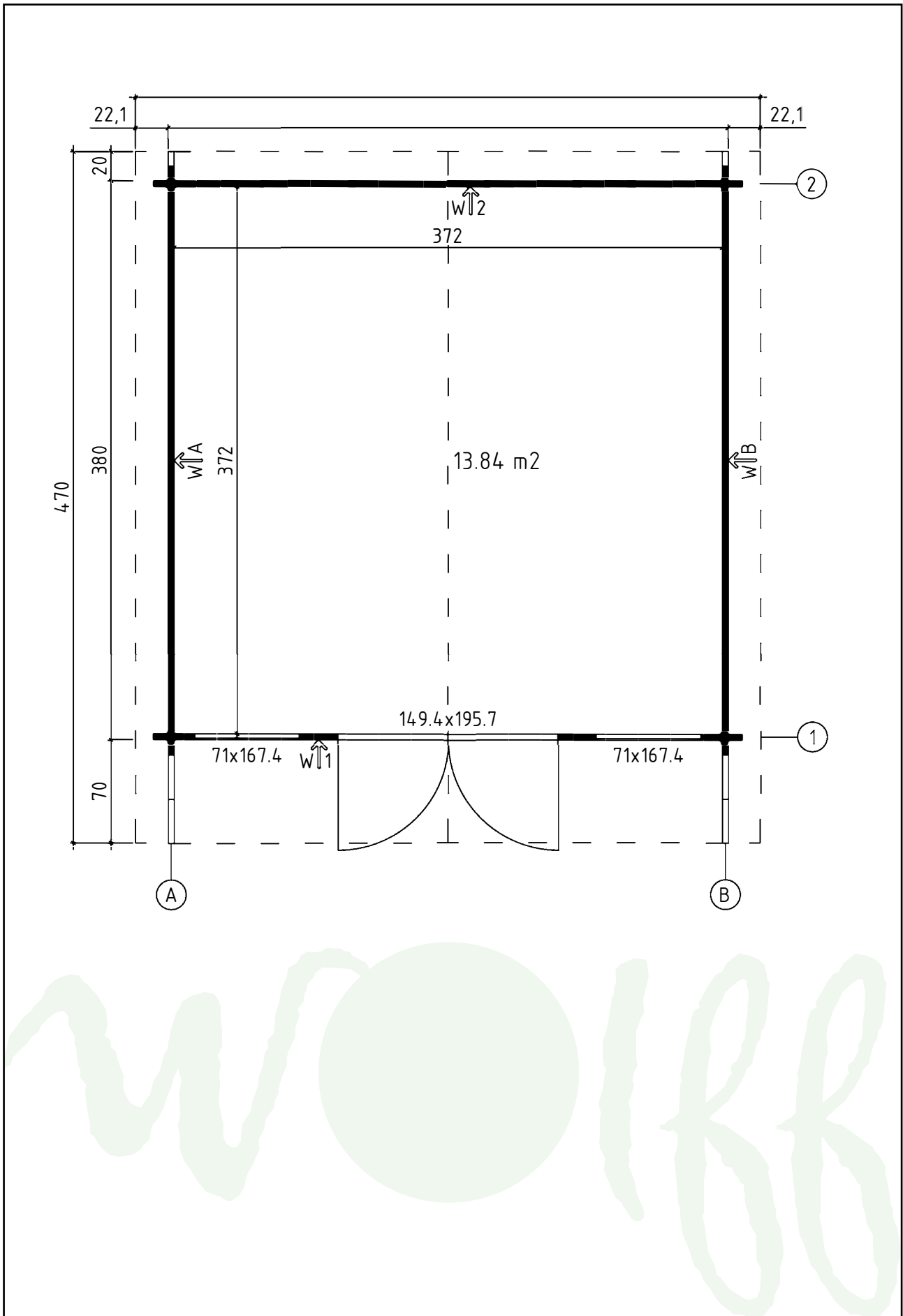



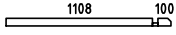
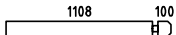

Grundriss Rotterdam Modern

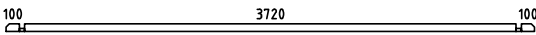
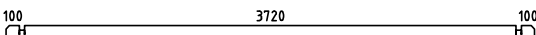
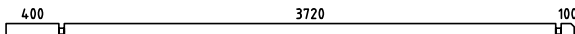
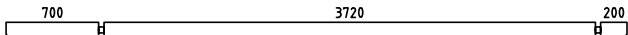
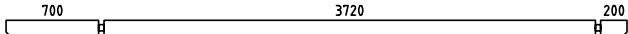
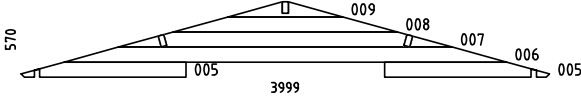
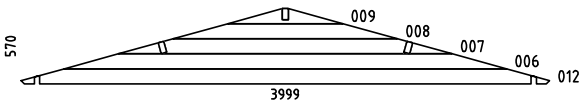
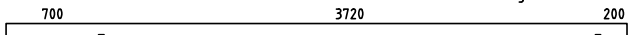

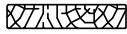

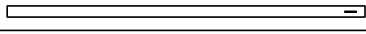

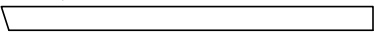
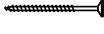
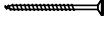
Teileliste 1

Rotterdam Modern

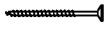
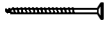
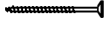
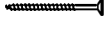
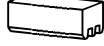

Pos	Piece list - Stückliste - Liste des pièces - Elementi - Stuklijst - Tükítabel 06.11.2019 Art. Nr. 4021896	5/6	Q	P (mm)	L (mm)
001			2	40x57	1248
002			2	40x114	1248
003			30	40x114	278
004			30	40x114	252
010			1	40x57	4000
011			4,6	40x114	4000
013			2	40x114	4300
014			1	40x114	4700
015			1	40x114	4700
W1-1			1		
W2-1			1		
A-PR1	Roof beam - Dachbalken - Panne de toit - Perlina del tetto - Gordingen / dakbalk - Pärlin 		3	44x140	4700
	Roof boards - Dachbretter - Voliges - Perlina per tetto - Dakhout - Katuselaud 		106	90x18	2200
	Roofing felt fillet - Dachpappenleiste - Baguette de fixation du feutre bitumeux - Asse per fissaggio guaina bituminosa - Afdekljst asfaltpapier - Katusepapiliist 		4	18x58	2250
TB-1	Fascia board - Traufbrett - Bandeau de toit - Finitura lati tetto - Gevellijst - Räästalaud 		4	18x90	2350
DRV-1	Roof edge reinforcement - Dachrandverstärkung - Corniere de renfort de bord de toit - Rinforzo x tetto - Dakrand versterking - Räästaturgevdus 		4	28x34	2350
KFS-2	Storm protection - Sturmleiste - Latte anti-tempete - Protezione anti vento - Stormverankering / beveiliging - Tormikinnitusliist 		2	22x45	2050
KFS-1	Storm protection - Sturmleiste - Latte anti-tempete - Protezione anti vento - Stormverankering / beveiliging - Tormikinnitusliist 		2	44x44	1900
	Gable moulding - Giebelleiste - Planche de rive - Finitura per frontale e retro del tetto - Gevellijst - Viilulaud 		4	18x120	2250
HS8	Screw for gable segment - Schrauben für deckblatt - Vis pour fixation losange de finition - Viti x frontali tetto - Schroef voor gevelpunt segment - Kruvi rombile 		4	3,5x35	
HS9	Screw for gable moulding - Schrauben für giebelleiste - Vis pour fixation planche de rive - Vite per fissare finiture davanti e dietro del tetto - Schroef voor gevellijst - Kruvi viilutauale 		24	3,5x50	

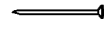
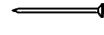
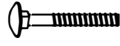
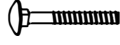
Teileliste 2

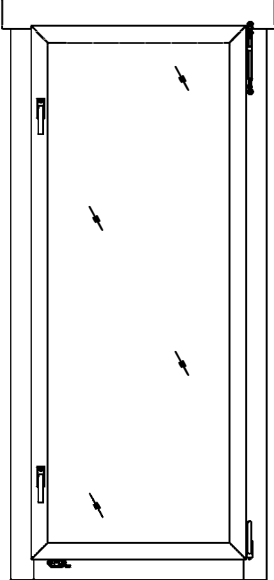
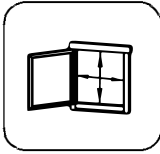

Rotterdam Modern

Pos		Q	P (mm)	L (mm)
HS12	Screw for fascia boards - Schrauben für traufbretter - Vis pour fixation bandeau de toit - Viti x striscia del tetto - Schroef voor gevellijst - Kruvi räästalauale 	24	4x40	
HS12	Screw for roof edge reinforcement - Schrauben für dachrandverstärkung - Vis pour fixation corniere renfort de bord de toit - Viti x rinforzo bordo tetto - Schroef voor dakrand versterking - Kruvi räästatugevdusele 	24	4x40	
HS18	Screw for roof beams - Schrauben für dachbalken - Vis pour fixation pannes de toit - Viti per perline del tetto - Schroef voor gordingen / dakbalken - Kruvi pärlinitele 	6	5x120	
HS18	Screw for gable - Schrauben für giebel - Vis pour fixation des pignons - Viti per timpano - Schroef voor gevelpunt - Kruvi viilude kinnitamiseks 	4	5x120	
SH40	Hammer block - Schlagholz - Calle de frappe - Blocco di legno da usare come cuscinetto quando si usa il martello - Slagklos - Löögiklots 	1		
SFS	Nut for storm protection - Schraubenmutter für sturmleiste - Ecrou pour latte anti-tempete - Dado x asta protezione vento - Moer voor stromverankering - Mutter tormikinnitusliistule 	16	D6	
NF4	Zn nail for roof - Zn nägel für dachbretter - Pointe pour fixation voliges de toit - Chiodi x perline tetto - Spijker(nagel) voor dakhout - Nael katuselauale 	332	2x50	
NF5	Zn nail for roofing felt fillet - Zn nägel für dachpappenteiste - Pointe pour baguette de fixation feutre bitumeux - Chiodi x carta bituminosa x tetto - Spijker(nagel) voor asfaltpapier afdekljst - Papiliistunael 	24	2x40	
BFS	Bolt for storm protection - Bolzen für sturmleiste - Boulon pour latte anti-tempete - Bullone x asta protezione vento - Bout voor stormankerlat - Puidupolt tormikinnitusliistule 	12	6x100	
BFS-2	Bolt for storm protection - Bolzen für sturmleiste - Boulon pour latte anti-tempete - Bullone x asta protezione vento - Bout voor stormankerlat - Puidupolt tormikinnitusliistule 	4	6x70	
GS	Gable segment - Deckblatt - Losange de finition - Decorazione in legno x frontale tetto - Gevelpunt segment - Romb 	2		
DFS	Washer for storm protection - Dichtscheibe für sturmleiste - Rondelle pour latte anti-tempete - Rondella x asta protezione vento - Afdichtring voor storm strip - Seib tormikinnitusliistule 	16	D6	
	Window - Fenster - Fenetre - Finestra - Raam - Aken 710x1674 AK.1.100.SSP.p SGC	1		
	Window - Fenster - Fenetre - Finestra - Raam - Aken 710x1674 AK.1.100.SSV.p SGC	1		
	Door - Tür - Porte - Deur - Uks 1494x1957 TUK.1.100.SVP.MMb SGC	1		

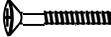



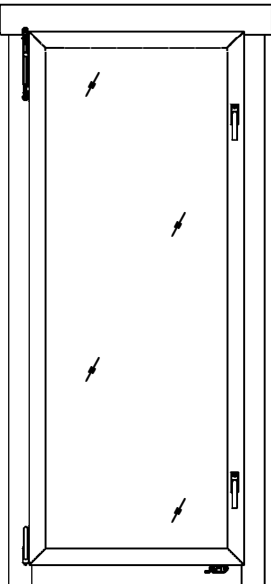
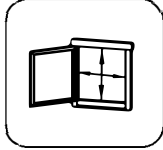

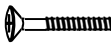
Teileliste Fenster Rotterdam Modern

Pos		P (mm)	L (mm)
	<p data-bbox="293 367 1171 394">Glass size - Glasgröße - Taille de la vitre - Misura del vetro - Glas afmeting - Klaasi mõõt: 566x1530 mm</p>   <p data-bbox="1235 533 1343 560">610x1574 mm</p>		
FS1	<p data-bbox="293 1980 944 2029">Window handle fittings - Fenstergriff - Poignee de fenetre - Maniglia c/ferramenta - Raamhendel -/grendel -/klink - Aknalink</p> 	2	
FSP	<p data-bbox="293 2047 1011 2114">Bolt for window handle fittings - Bolzen für fenstergriff beschlag - Vis pour fixation poignee de fenetre - Bullone x apertura manuale finestra - Schroef voor raamhendel - Akna käepideme polt</p> 	4	

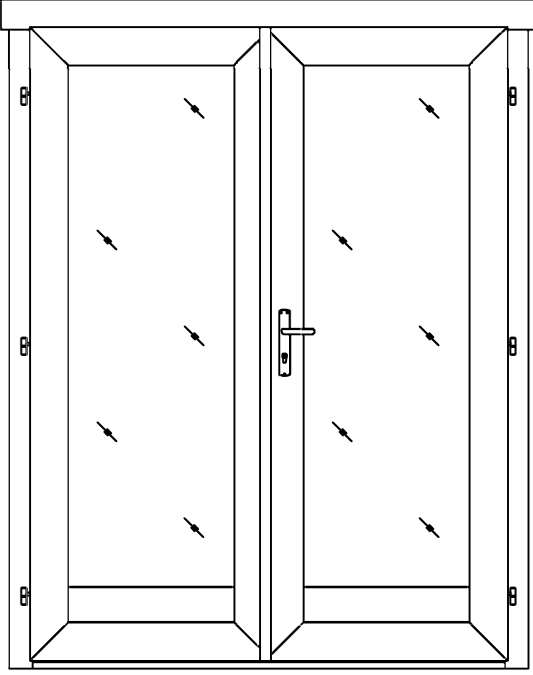
Teileliste Fenster Rotterdam Modern

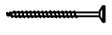
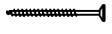
Pos		P (mm)	L (mm)
	<p data-bbox="277 367 1136 394">Glass size - Glasgröße - Taille de la vitre - Misura del vetro - Glas afmeting - Klaasi mõõt: 566x1530 mm</p> <div data-bbox="651 443 922 1025" style="text-align: center;">  </div> <div data-bbox="1193 367 1356 515" style="text-align: center;">  </div> <p data-bbox="1219 533 1331 560">610x1574 mm</p>		
FS1	<p data-bbox="277 1980 932 2029">Window handle fittings - Fenstergriff - Poignee de fenetre - Maniglia c/ferramenta - Raamhendel -/grendel -/klink - Aknalink</p>		2
FSP	<p data-bbox="277 2047 1002 2114">Bolt for window handle fittings - Bolzen für fenstergriff beschlag - Vis pour fixation poignee de fenetre - Bullone x apertura manuale finestra - Schroef voor raamhendel - Akna käepideme polt</p>		4

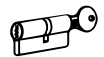
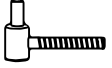
Teileliste Tür Rotterdam Modern

		Q	P (mm)	L (mm)
	<p>Glass size - Glasgröße - Taille de la vitre - Misura del vetro - Glas afmeting - Klaasi mõõt: 514x1593 mm</p>   <p>1394x1875 mm</p>			
HS4	<p>Screw for door fillet - Schraube zur Befestigung Türleiste - Vis pour fixation baguette d'arrêt de porte - Viti per massellino della porta - Schroef voor deurlijst - Kruvi ukse kokkuvältsiliistule</p> 	5	3x30	
HS16	<p>Screw for door jamb - Schraube für Türrahmen - Vis de fixation partie haute avec montants du cadre de porte - Viti x fissaggio montanti porte - Schroef voor deurkozijn - Kruvi ukse lengile</p> 	4	5x90	
HS25	<p>Screw for doorstep - Schrauben für Swelle - Vis pour fixation barre de seuil - Vite per soglia della porta - Schroef voor deurdorpel - Kruvi lävepakule</p> 	3	4.5x65	
TL4	<p>Door handle fittings - Türgriff - Poignée de porte - Maniglie - Deurhendel klink - Ukse käepide</p> 	1		
TL5	<p>Set of door lock covers - Schlossblenden - Set de garnitures de porte - Copertura serrature - Slot sluitplaat set - Ukse lukuplaat</p> 	1		
	<p>Cylinder lock - Zylinderschloss - Barillet de porte - Serratura - Cylinder slot - Ukse lukusüdamik</p> 	1	30x35	
	<p>Male bolt hinge for door - Türband - Partie male de paumelle de porte - Cerniera anube x porta - Scharnier bout - Ukse polthing isane</p> 	6		
	<p>Striker for barrel bolt - Hülse für Grendelriegel - Gache au sol du targette - Boccola per fermo della porta - Huls voor vergrendelingsschuif - Vasturaud ukse servariivile</p> 	2		

Wandplan Rotterdam Modern

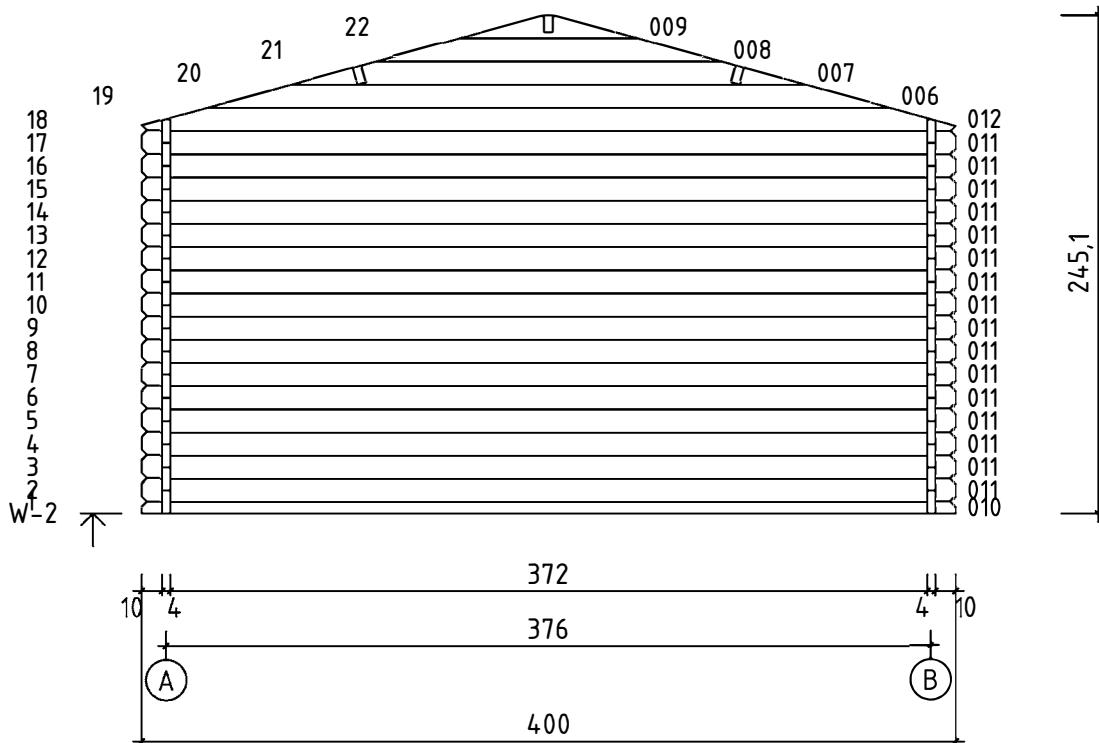
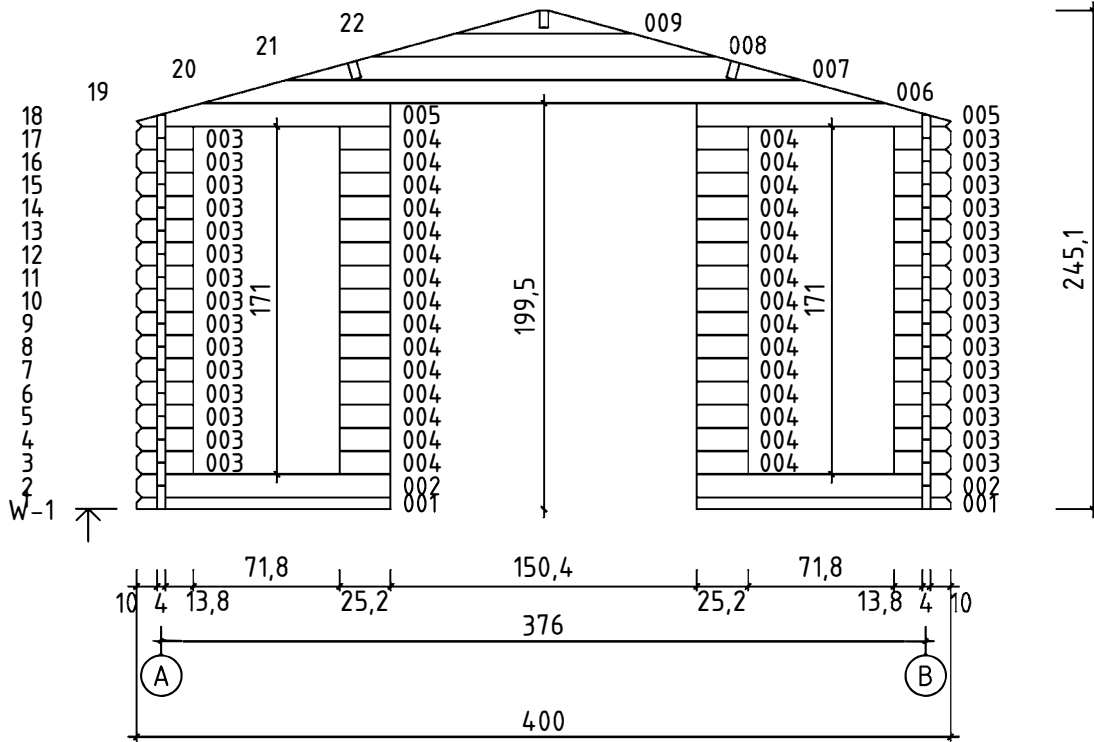

Wandplan Rotterdam Modern

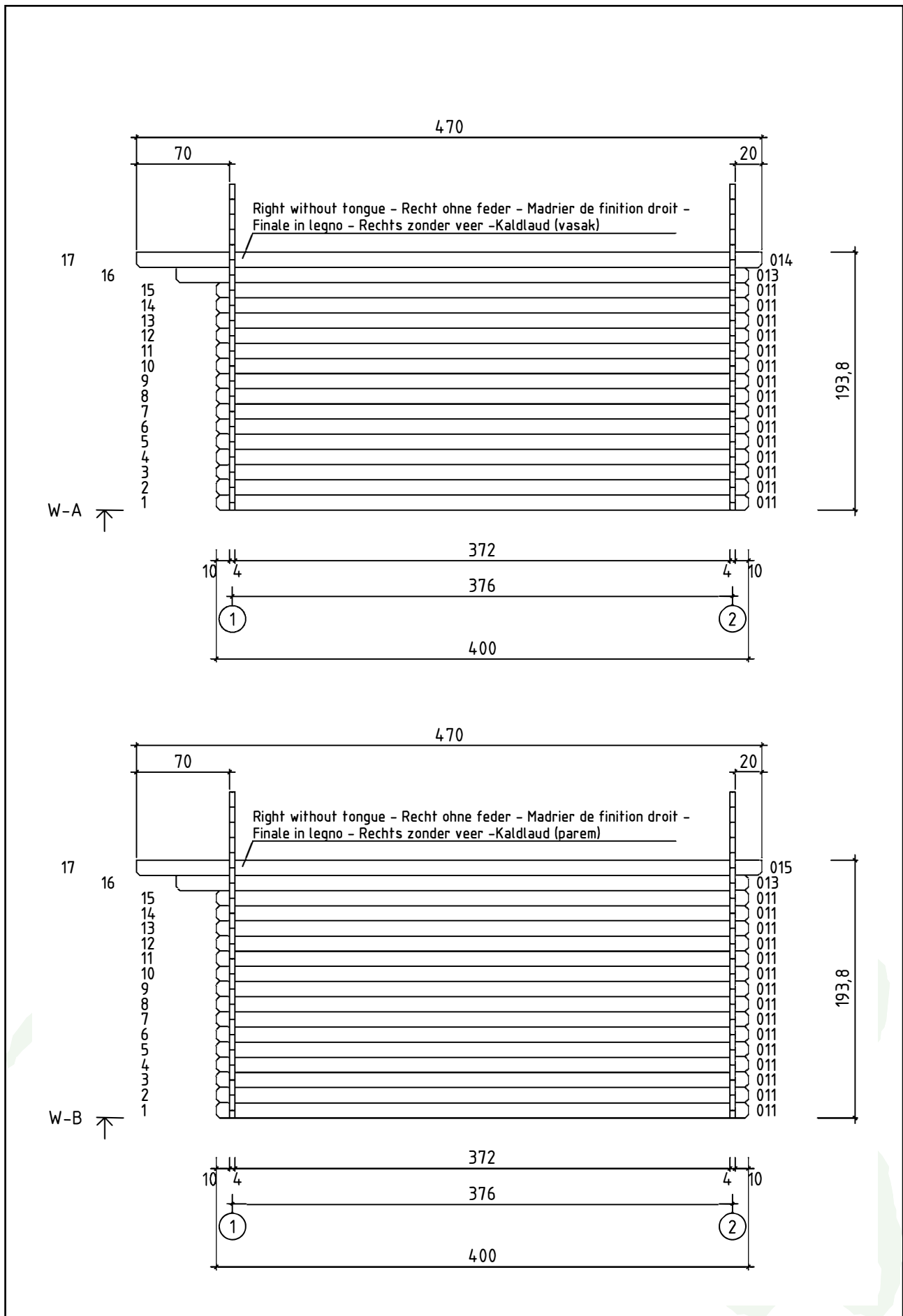

Sturmleiste-Frontseite Rotterdam Modern

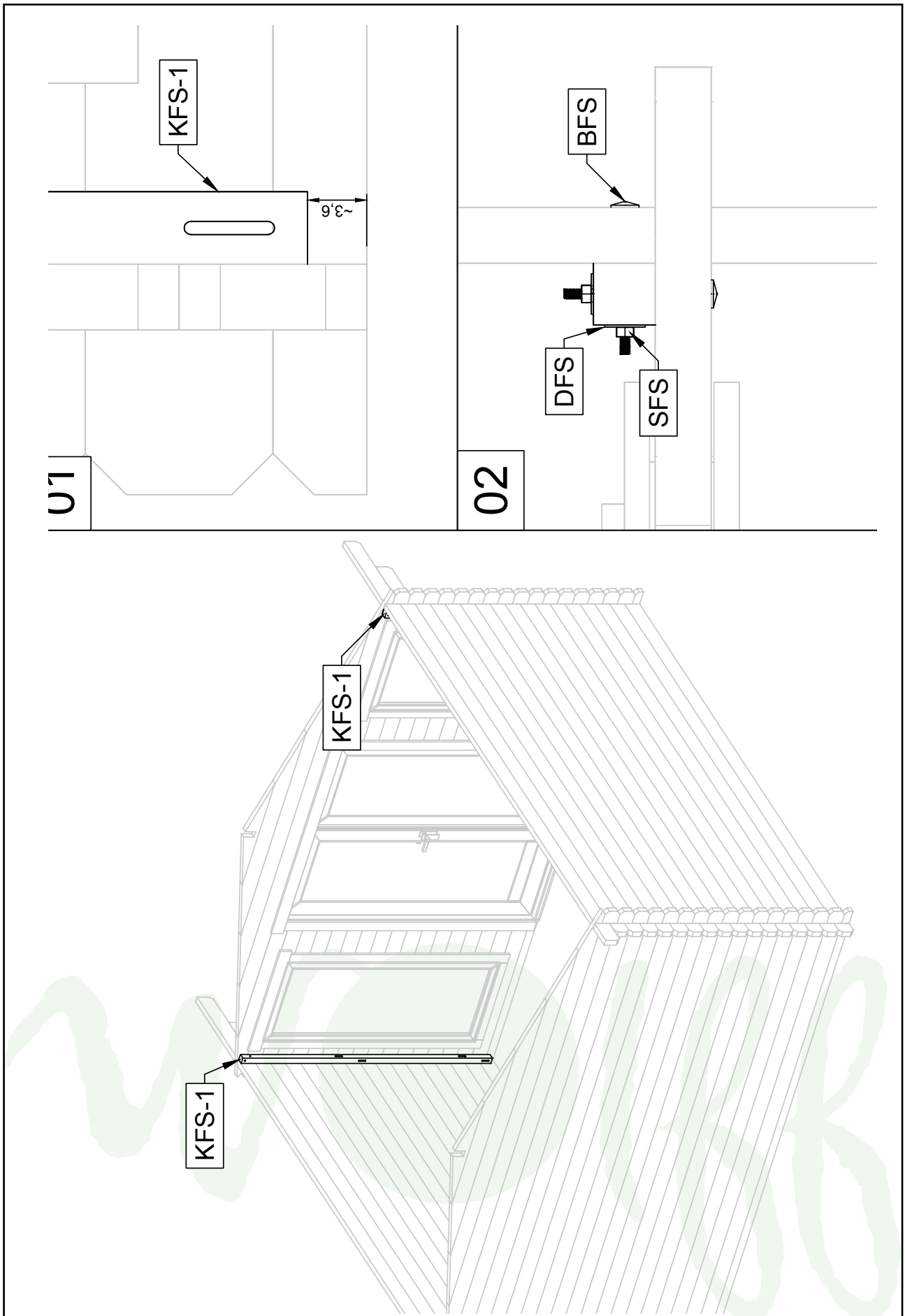

Detail Fenster Rotterdam Modern

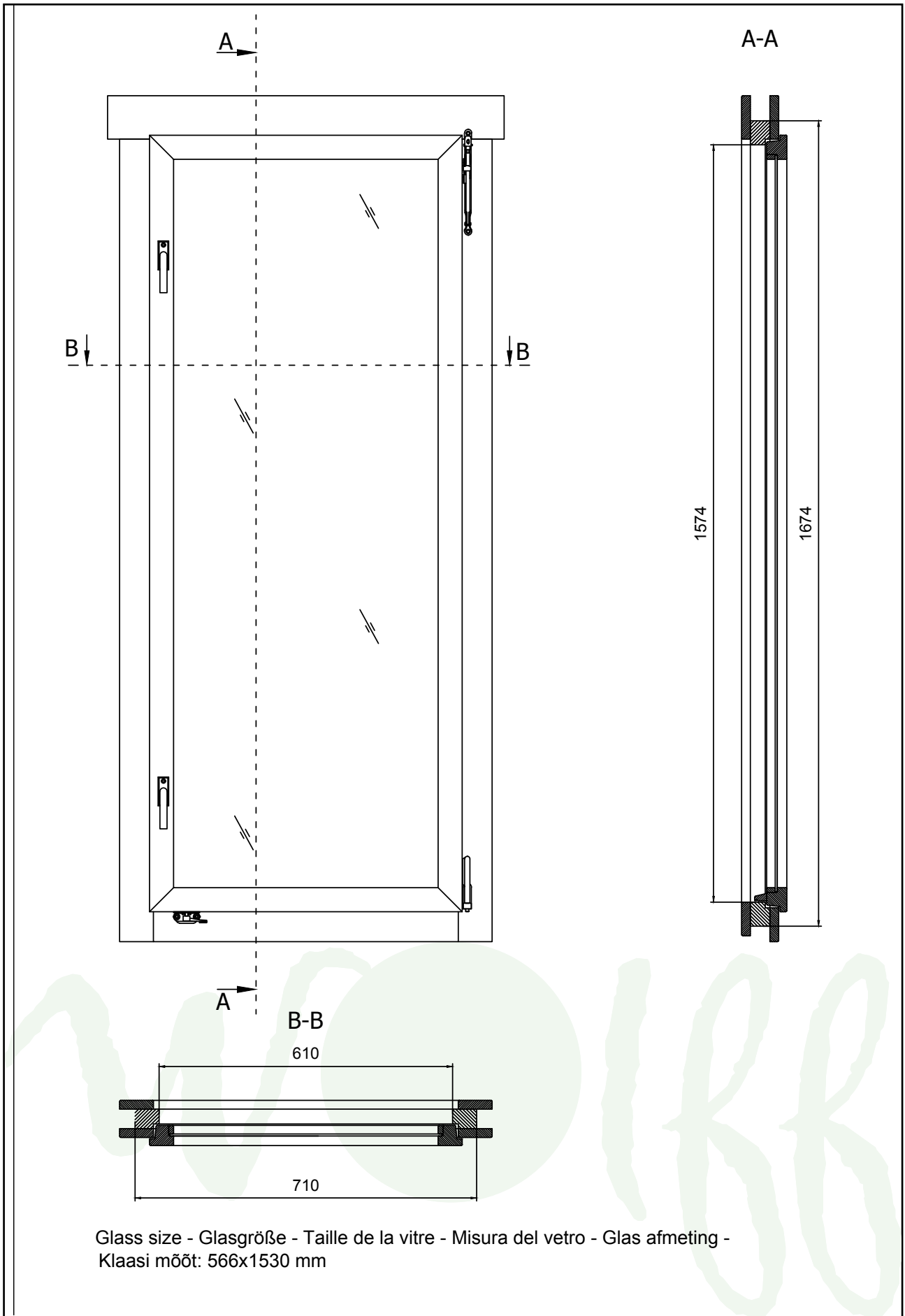

Detail Fenster Rotterdam Modern

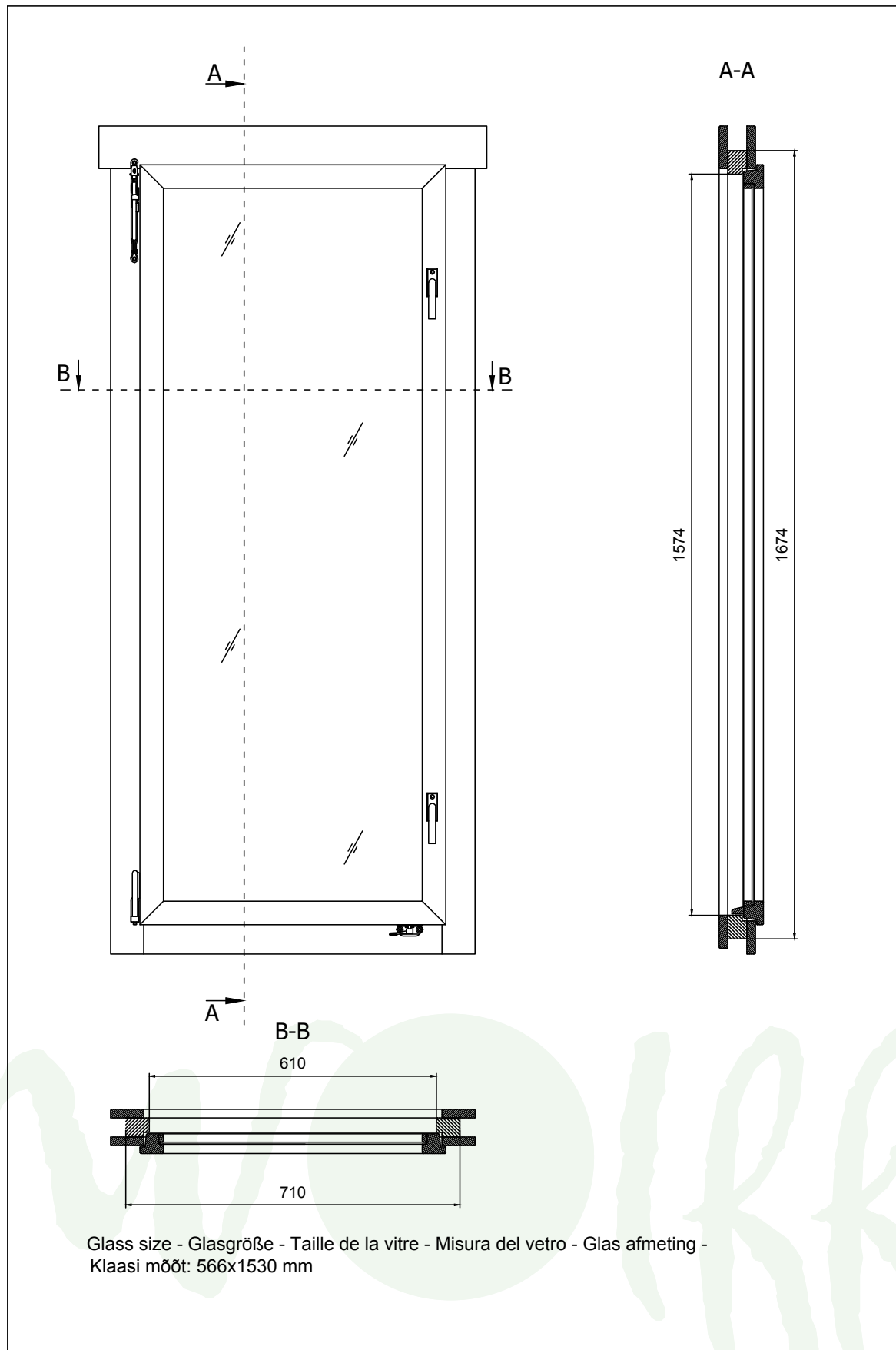

Detail Tür Rotterdam Modern

