

Pulti moderna B

Wandaußenmaß: 300 x 240 cm

Bohlenstärke: 28 mm



Kontrolliert durch:

Achtung: Alle angegebenen Maße sind ca.-Maße!

3D-Darstellung und Grundriss Pulti moderna B

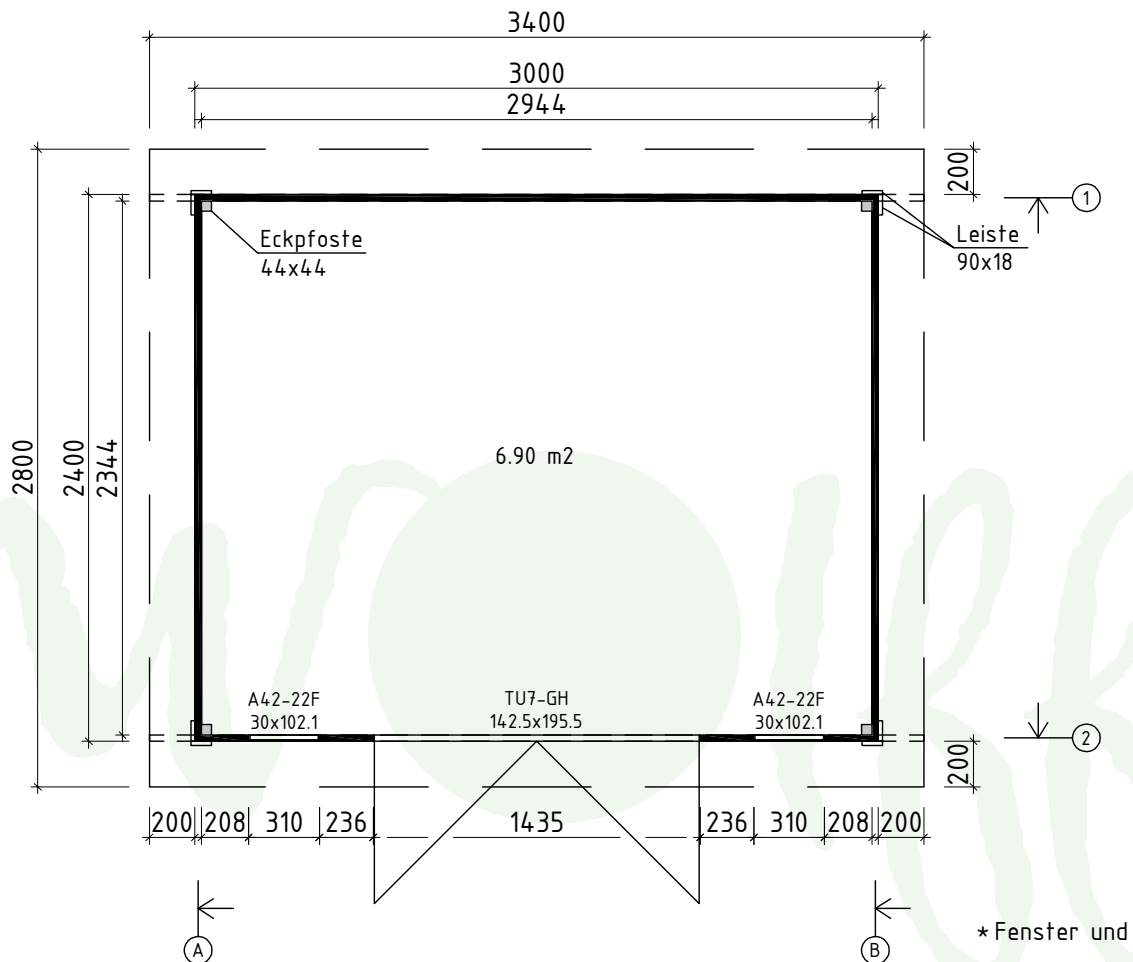
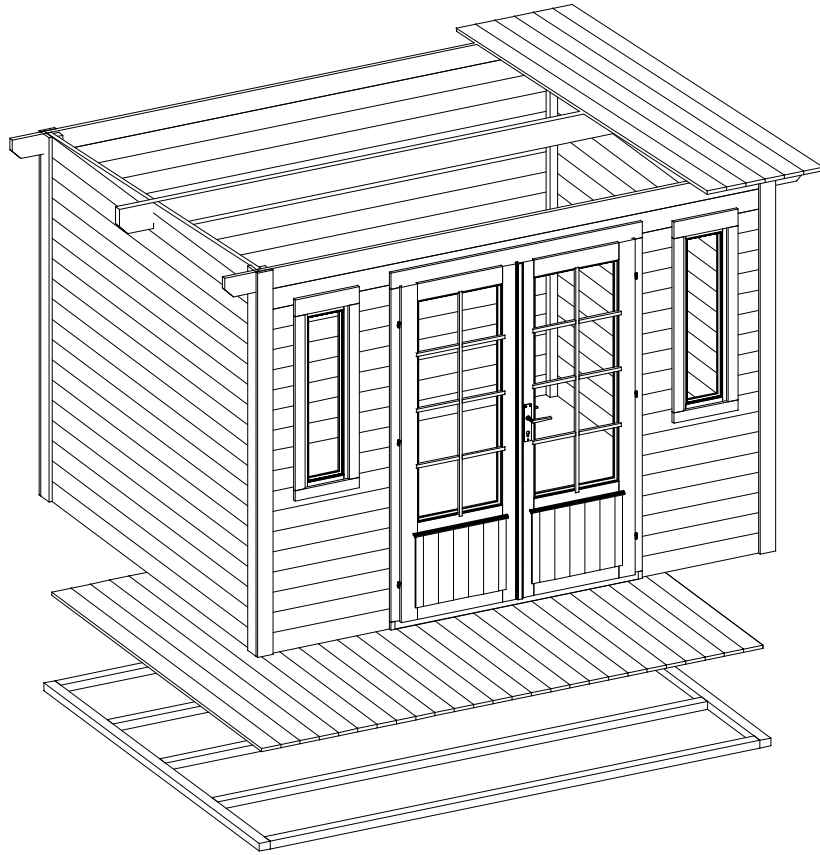

Lagerholzplan und Fundamentplan Pulti moderna B

Wir empfehlen als Fundament für Ihr Gartenhaus eine vollflächig, festgegründete gepflasterte oder betonierte Fläche.
Wahlweise ist auch ein Punkt- oder Streifenfundament möglich.

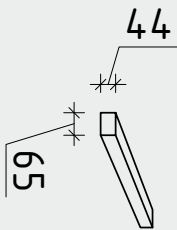
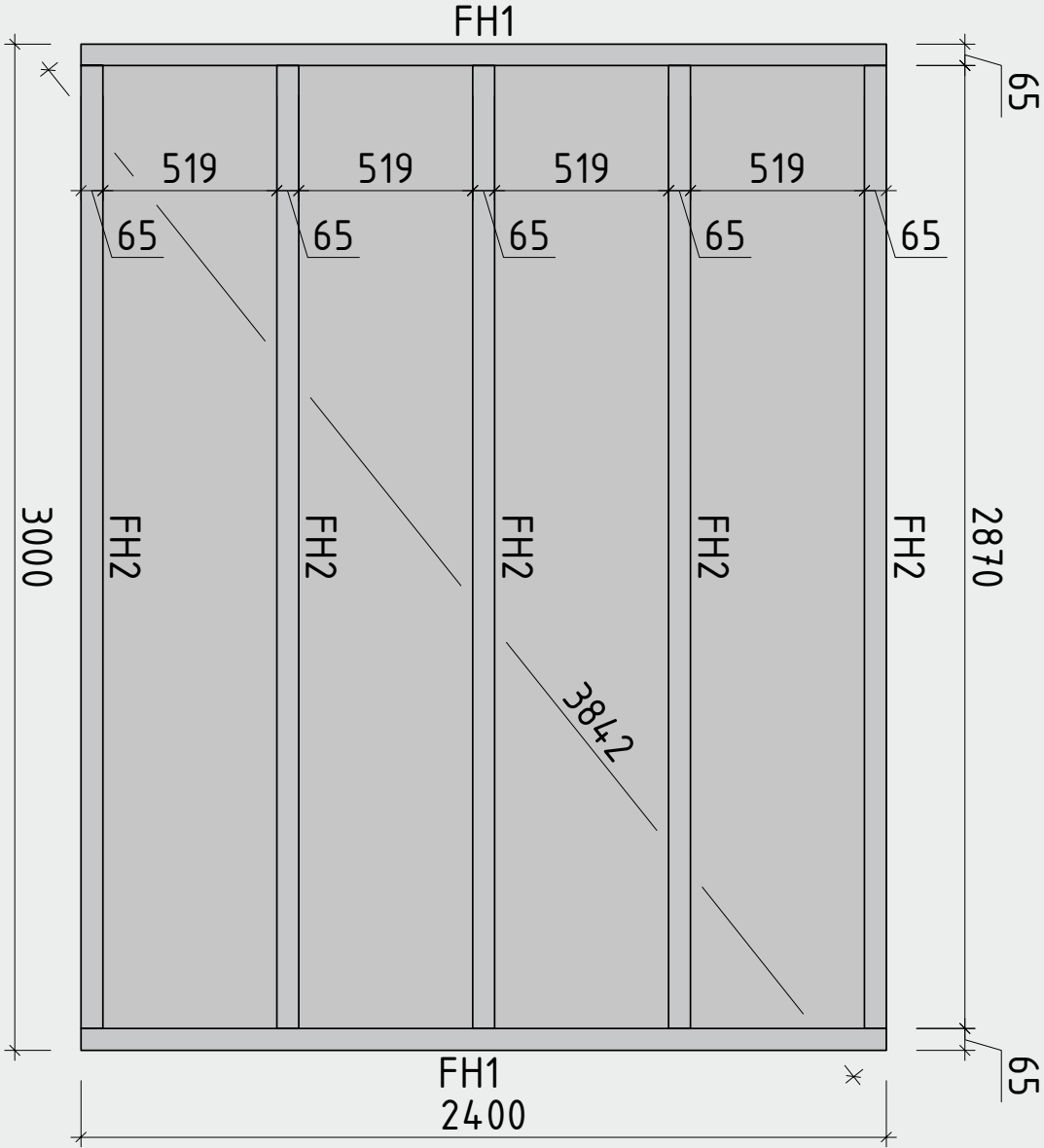









Teileliste 1

Pulti moderna B

Pos	Teileliste Pulti Moderna B 240x300 28	Stck.	Profil (mm)	Länge (mm)
001		2	28x114	3400
002		1	28x114	3000
003		17	28x114	3000
004		36	28x114	2344
005		2	28x114	2344
006		14	28x114	768
007		2	28x114	768
008		18	28x114	221
009		18	28x114	206
FH2	FUNDAMENTHÖLZER (imprägniert) 	5	65x44	2870
FH1	FUNDAMENTHÖLZER (imprägniert) 	2	65x44	2400
LE2	LEISTE 	✓ 4	90x18	2166
LE1	LEISTE 	✓ 4	90x18	2052
LE4	LEISTE 	2	15x28	1938
LE3	LEISTE 	4	15x28	1016
EP2	ECKPFOSTEN 	2	44x44	2156
EP1	ECKPFOSTEN 	2	44x44	2042
PF1	PFETTEN 	1	44x14,5	3400
	DACHBRETTER	31+1	113x18	2800
	FUSSBODENBRETTER	27+1	113x18	2340
	FUSSBODENLEISTE	✓	18x40	11,0 lfm
G1-1	GIEBELBRETTER 120X18	2	120x18	2820
G6-1	GIEBELDECKLEISTE 40X18	✓ 2	40x18	2820
T1-1	TRAUFENBRETTER 120X18	1	120x18	3436
T2-1	TRAUFENBRETTER 90X18	1	90x18	3400

Teileliste 2

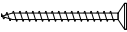
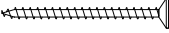
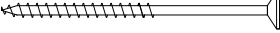
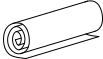
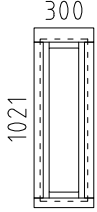
Pulti moderna B

Pos	Teileliste Pulti Moderna B 240x300 28	Stck.	Profil (mm)	Länge (mm)
T6-1	TRAUFENDECKLEISTE 40x18 	1	40x18	3436
T4-1	TRAUFENLEISTE 40x18  ✓		40x18	7,0 lfm
SH	Schlaghölzer  	3		
NG3	DACHPAPPNÄGEL 2.0x18 	200		
NG1	NÄGEL 2.5x50 Dachbretter Fussbodenbretter 	456		
SR01	SCHRAUBEN 3.0x30 Fussbodenleisten Traufenleisten, Giebeldeckleisten 40x18 	53		
SR03	SCHRAUBEN 3.5x45 Giebelbretter, Traufenbretter LE1, LE2, LE3, LE4 	176		
SR05	SCHRAUBEN 4.0x60 Wandbohlen zu Eckpfosten 	296		
SR11	SCHRAUBEN 5.0x100 Fundamenthölzer 	20		
	DACHPAPPE  ✓		3,4m-4st.	14,0 lfm
	AKEN 300x1021  A42-22F	2		
	UKS 1425x1955  TU7-GH DIN rechts	1		
	✓ - bitte selber anpassen (falls nötig)!			

Wandplan 1 Pulti moderna B

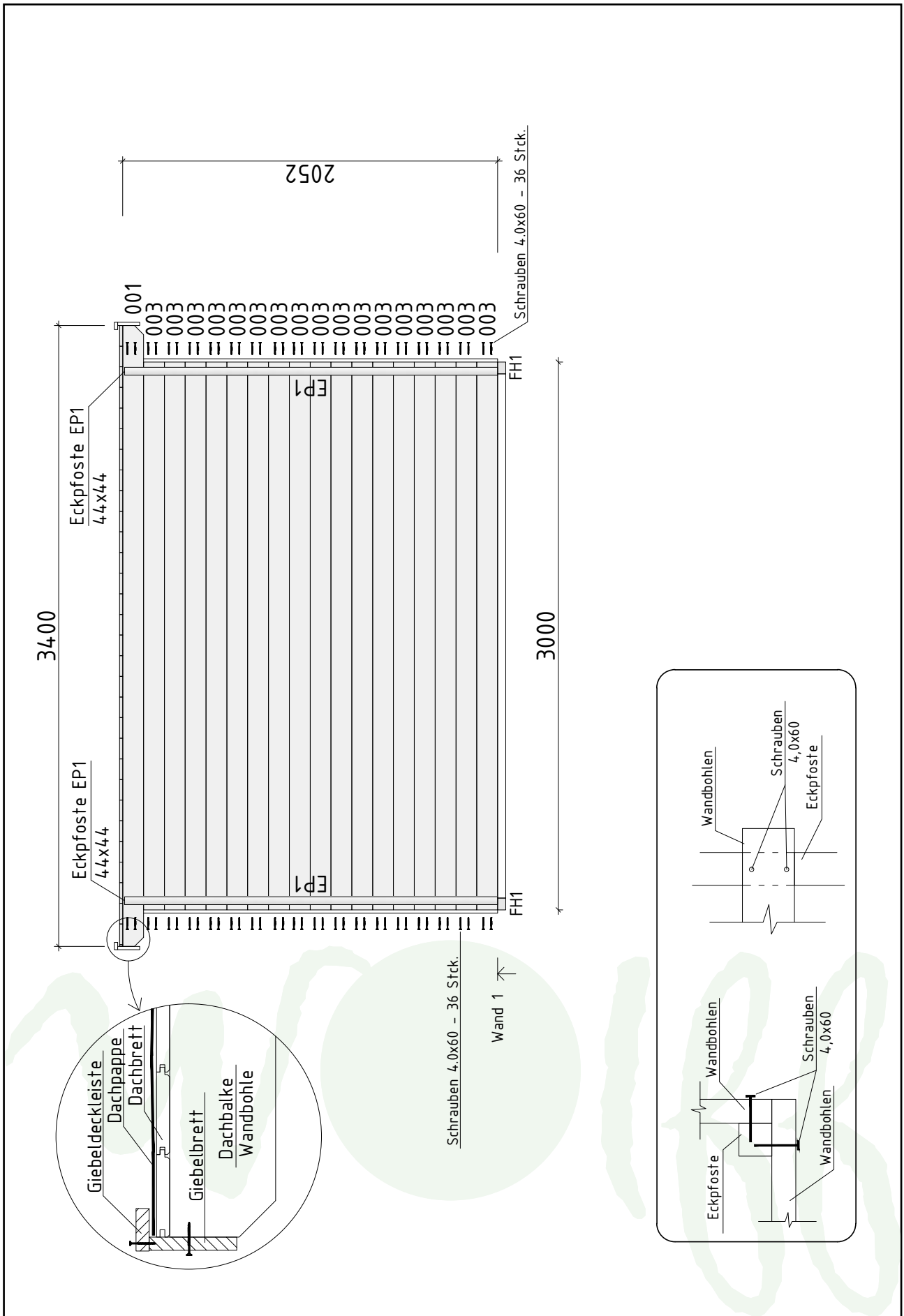

Wandplan 2 Pulti moderna B

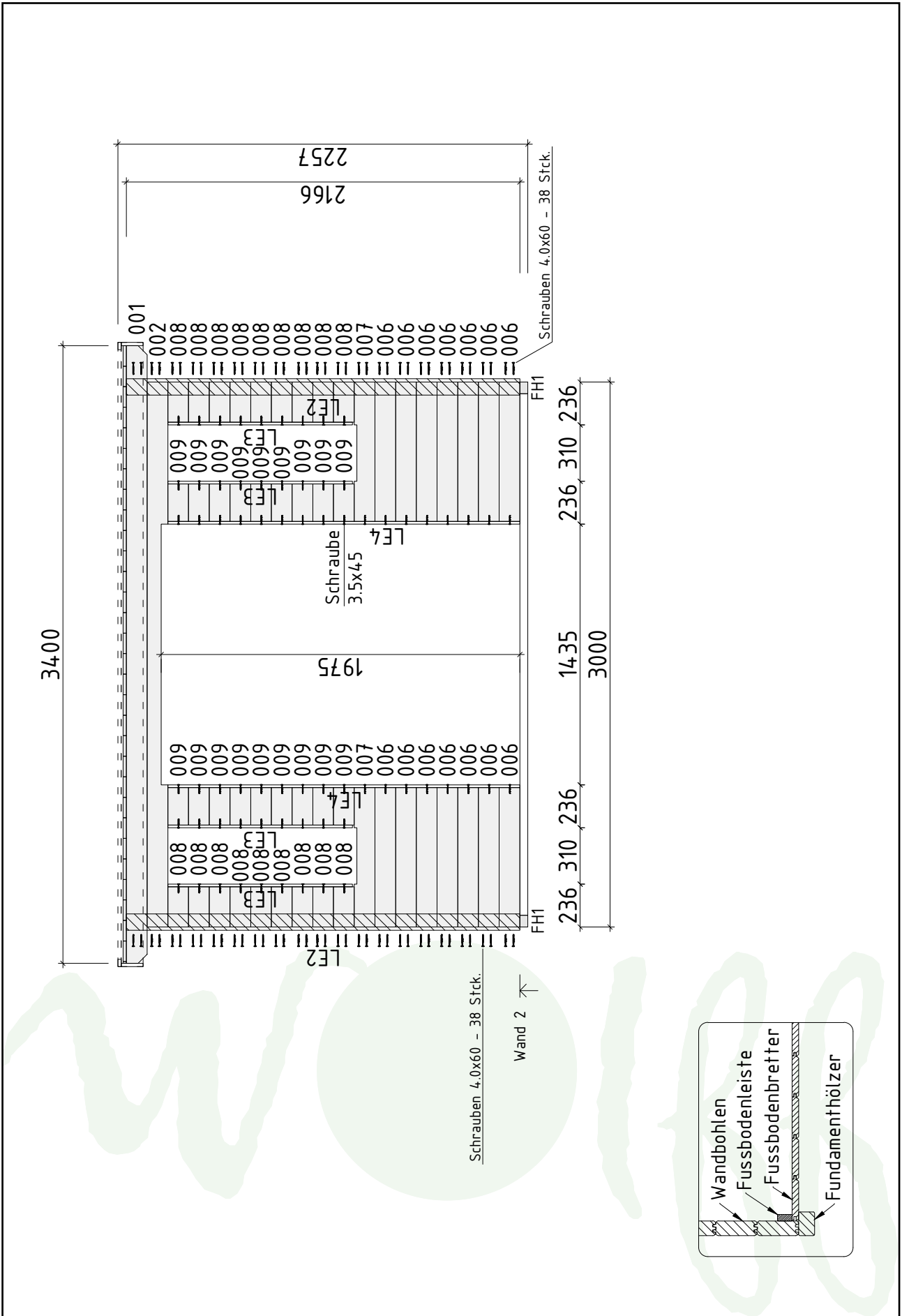

Wandplan A Pulti moderna B

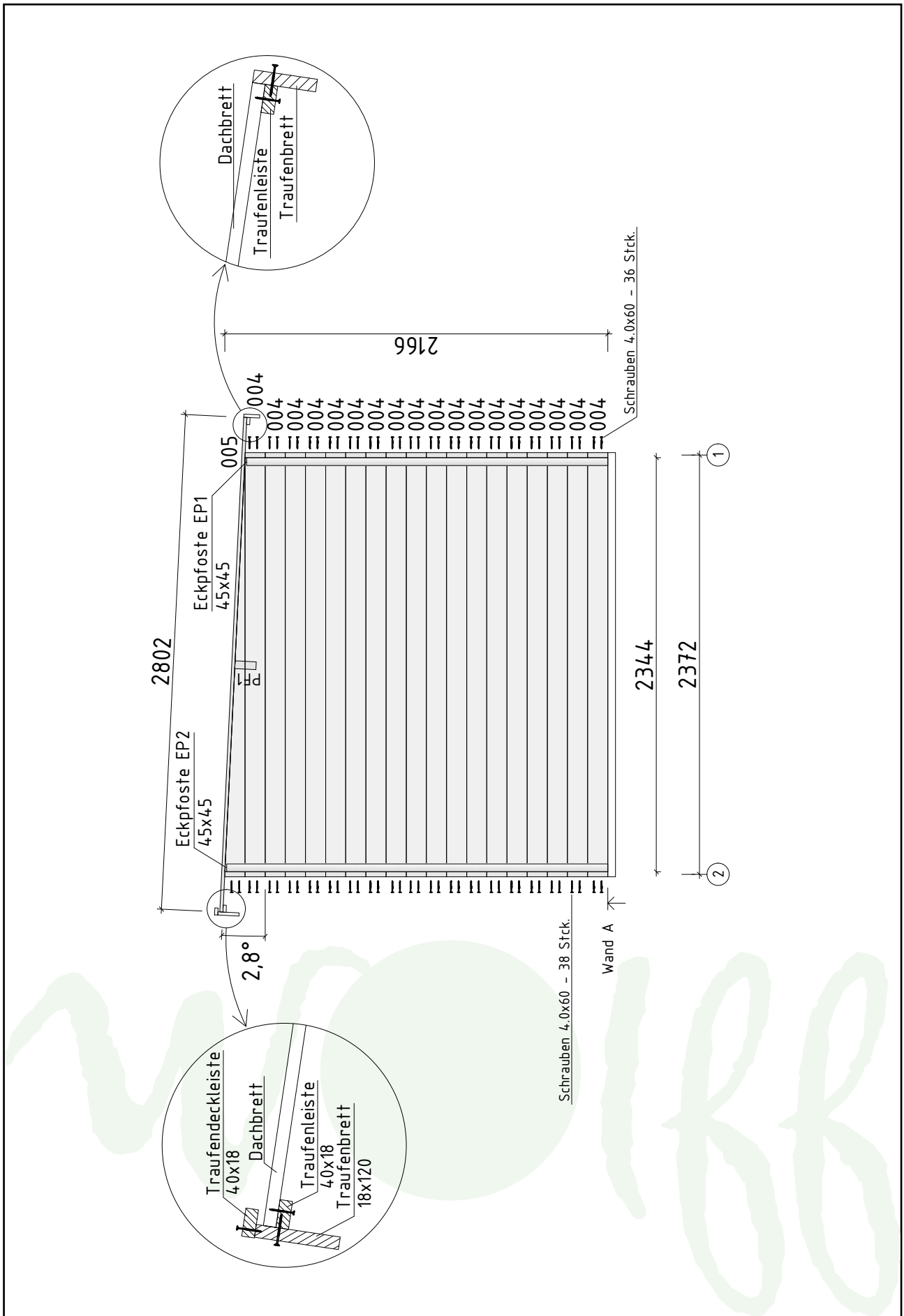

Wandplan B

Pulti moderna B

