

Paris A

Wandaußenmaß: 300 x 300 cm

Bohlenstärke: 28 mm



Kontrolliert durch:





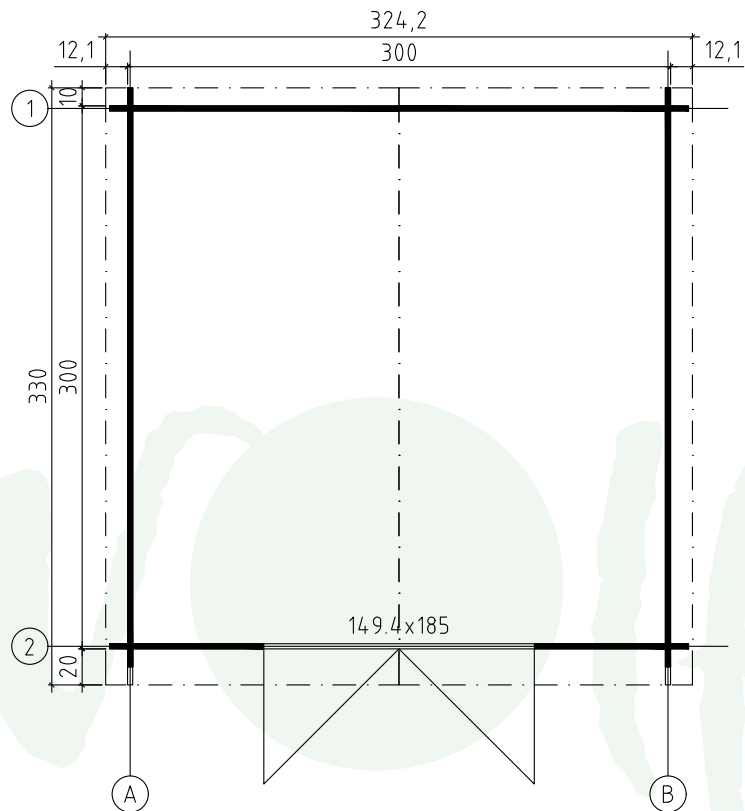





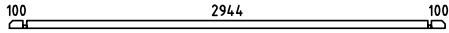
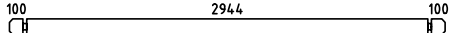
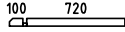
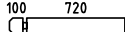
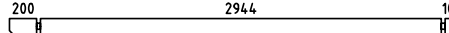
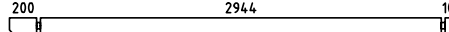

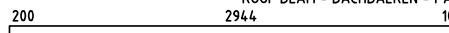
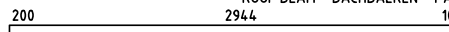

Achtung: Alle angegebenen Maße sind ca.-Maße!

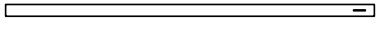
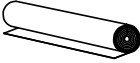
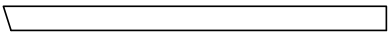
3D-Darstellung und Grundriss Paris A

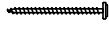





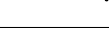





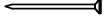

Teileliste 1

Paris A

Pos		Q.	P. (mm)	L. (mm)
001		1	28x57	3200
002		48	28x114	3200
006		2	28x57	848
007		32	28x114	848
008		1	28x120	3300
009		1	28x120	3300
W1-1 W2-1		2		
PR1	 ROOF BEAM - DACHBALKEN - PANNE DE TOIT	1	44x120	3300
A-PR1	 ROOF BEAM - DACHBALKEN - PANNE DE TOIT	2	44x120	3300
	ROOF BOARDS - DACHBRETTER - VOLIGES 	74	90x15	1650
	ROOFING FELT FILLET - DACHPAPPENLEISTE - BAGUETTE DE FIXATION DU FEUTRE BITUMEUX 	4	15x45	1700
	EAVES BOARD - TRAUFBRETT - BANDEAU DE TOIT 	2	15x45	3300
KFS-1	STORM PROTECTION - STURMLEISTE LATTE ANTI-TEMPETE 	4	22x45	2050
DPP-1	ROOFING FELT - DACHPAPPE - FEUTRE BITUMEUX 	4		3400
	GABLE MOULDING - GIEBELLEISTE PLANCHE DE RIVE 	4	15x90	1700
HS12	SCREW FOR GABLE SEGMENT - SCHRAUBEN FÜR DECKBLATT - VIS POUR FIXATION LOSANGE DE FINITION 	4	3.5x35	
HS22	SCREW FOR FIXING DOOR TO THE WALL - SCHRAUBE ZUR BEFESTIGUNG TÜR- ZARGE MIT WAND - VIS DE FIXATION DORMANT DE PORTE 	2	3.5x50	
HS59	SCREW FOR DOORSTEP - SCHRAUBEN FÜR SWELLE - VIS DE FIXATION DU SEUIL DE PORTE 	3	4.5x65	
HS56	SCREW FOR FIXING BOLT HINGE - SCHRAUBE FÜR TÜRRIEGEL - VIS DE FIXATION POUR CHARNIERES ET GONDS DE PORTE 	16	4x30	
HS58	SCREW FOR FIXING BOLT HINGE - SCHRAUBE FÜR TÜRRIEGEL - VIS DE FIXATION POUR CHARNIERES ET GONDS DE PORTE 	12	4x40	
	SCREW FOR GEORGIAN BARS - SCHRAUBE FÜR SPROSSEN - VIS DE BARRES GEORGIANNE 	12	2.5x20	
HS43	SCREW FOR ROOF BEAMS - SCHRAUBEN FÜR DACHBALKEN - VIS POUR PANNE DE TOIT 	10	5x120	
HS41	SCREW FOR DOOR JAMB - SCHRAUBE FÜR TÜRRAHMEN - VIS DE FIXATION POUR MONTANT DE PORTE 	2	5x90	
HS3	SCREW FOR DOOR FILLET - SCHRAUBE ZUR BEFESTIGUNG TÜRLEISTE - VIS D'ASSEMBLAGE DU CADRE DE PORTE 	5	3x30	
HS32	SCREW FOR EAVES BOARDS - SCHRAUBEN FÜR TRAUFBRETTER - VIS DE FIXATION POUR BANDEAU DE TOIT 	16	4x40	

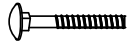
Teileliste 2

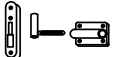
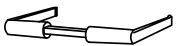
Paris A

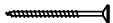
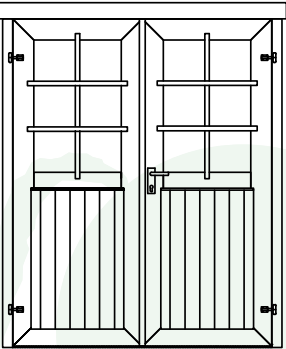
Pos		Q.	P. (mm)	L. (mm)
TL5	DOOR HANDLE FITTINGS - TÜRGRIF - SET DE GARNITURES DE SERRURE DE PORTE 	1		
SH28	HAMMER BLOCK - SCHLAGHÖLZ - CALLE DE FRAPPE 28 mm 	1		
NF2	ZN NAIL FOR ROOF - ZN NÄGEL FÜR DACHBRETTER - POINTE POUR TOIT 	236	2x50	
NFD	ZN NAIL FOR ROOFING FELT FILLET - ZN NÄGEL FÜR DACHPAPPENLEISTE - POINTE POUR BAGUETTE FIXATION FEUTRE BITUMEUX 	16	2x40	
NF	ROOFING NAILS FOR ROOFING FELT - NÄGEL FÜR DACHPAPPE - POINTE DE FIXATION POUR FEUTRE BITUMEUX 	138	2.8x15	
HS16	SCREW FOR GABLE MOULDING - SCHRAUBEN FÜR GIEBELLEISTE - VIS DE FIXATION POUR PLANCHE DE RIVE 	24	3.5x50	
TL	LATCH BOLT FÜR DOUBLE DOOR - TORRIEGEL - LOQUET POUR DOUBLE PORTE 	2		90
GS	GABLE SEGMENT-DECKBLATT - LOSANGE DE FINITION 	2		
SFS	NUT FOR STORM PROTECTION - SCHRAUBENMUTTER FÜR STURMLEISTE - ÉCROU POUR LAME ANTI-TEMPÊTE 	8	D6	
BFS	BOLT FOR STORM PROTECTION - BOLZEN FÜR STURMLEISTE - VIS POUR LAME ANTI-TEMPÊTE 	8	6x60	
DFS	WASHER FOR STORM PROTECTION - DICHTSCHEIBE FÜR STURMLEISTE - RONDELLE POUR LAME ANTI-TEMPÊTE 	8	D6	
	MALE BOLT HINGE FOR DOOR - TÜRRIEGEL - PARTIE MALE DE CHARNIERE DE PORTE 	4		
TL4	DOOR HANDLE FITTINGS - TÜRGRIF - GARNITURE DE POIGNÉE DE PORTE 	1		
	CYLINDER - ZYLINDERSCHLOSS - CYLINDRE DE SERRURE 	1	30/30	
HS41	SCREW FOR DOOR JAMB - SCHRAUBE FÜR TÜRRAHMEN - VIS DE FIXATION POUR MONTANT DE PORTE 	2	4x60	
	DOOR - TÜR - PORTE 1494x1850 SGA+28 TUK.2.056.SVP.MMX28 	1		

Wandpläne 1 und 2 Paris A

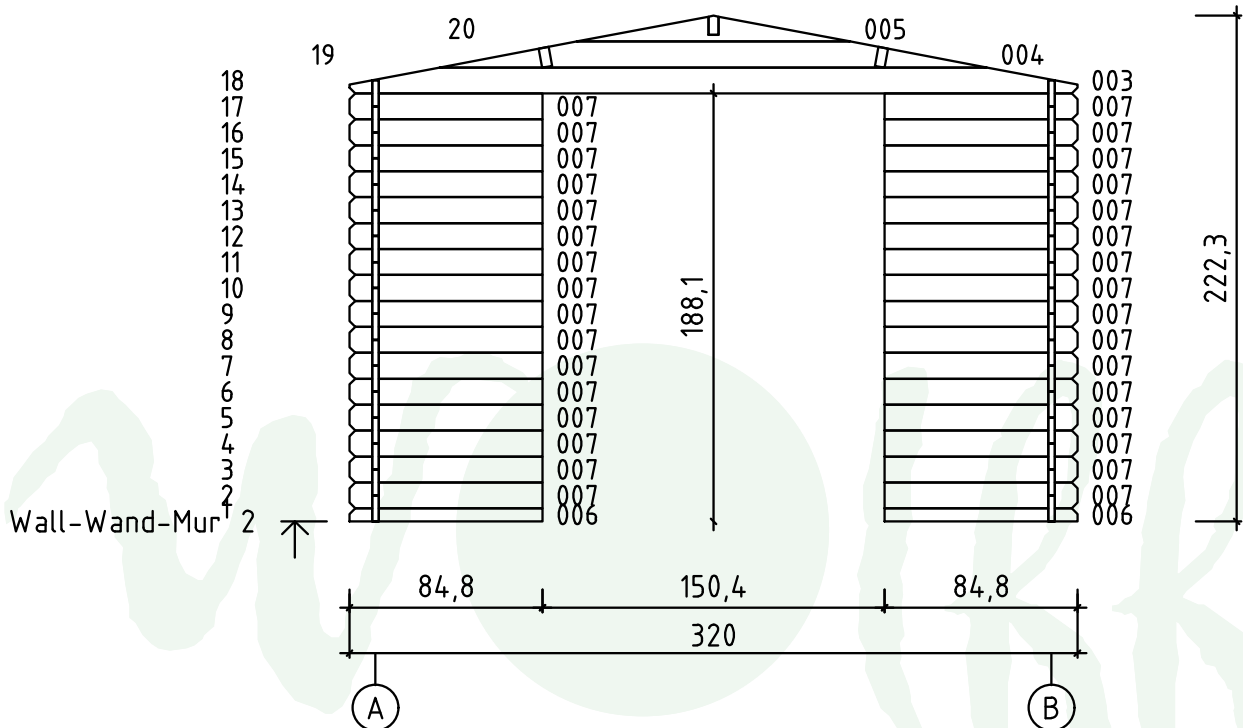
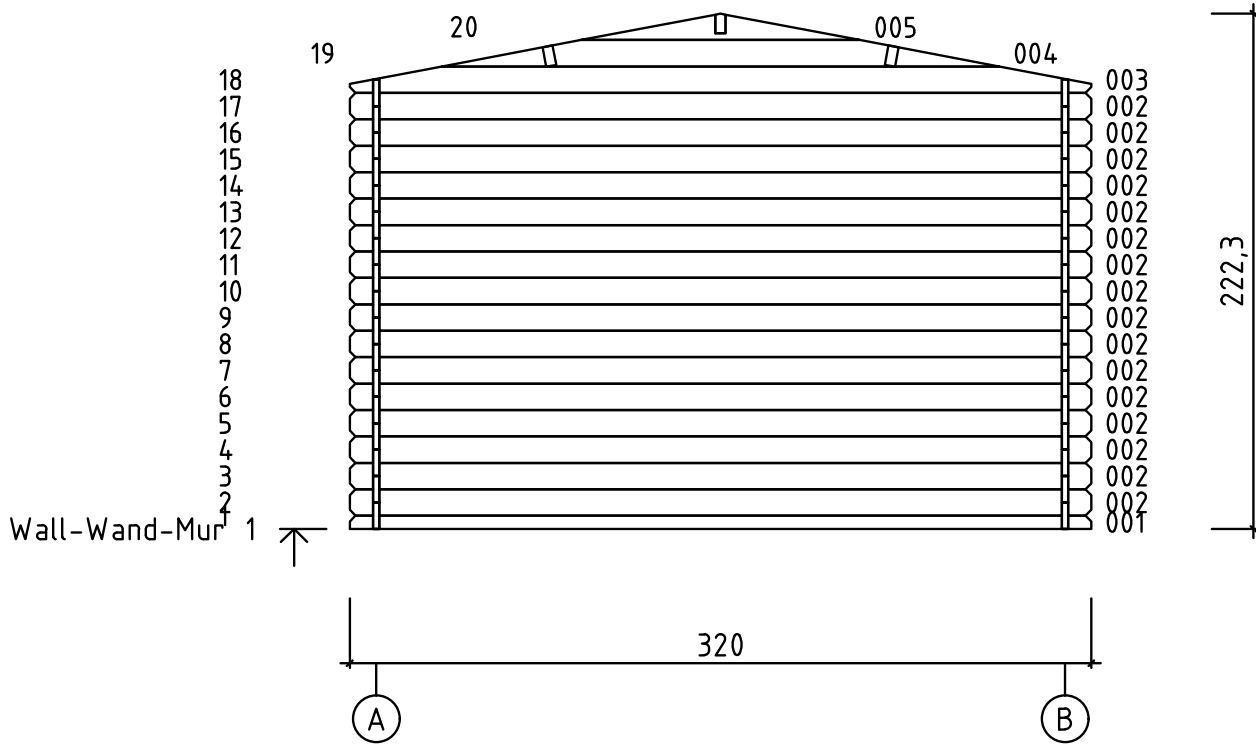



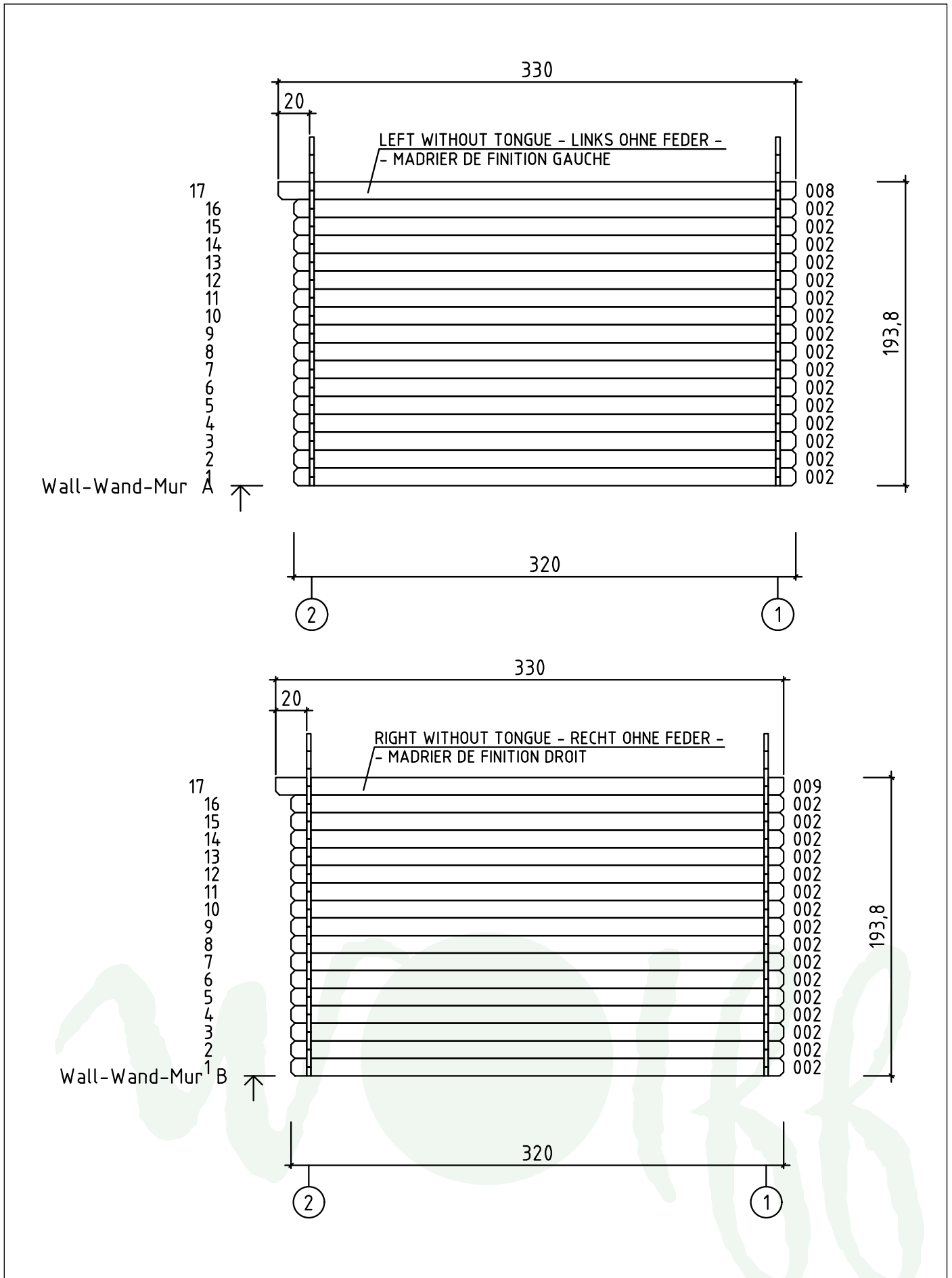

Wandpläne A und B Paris A

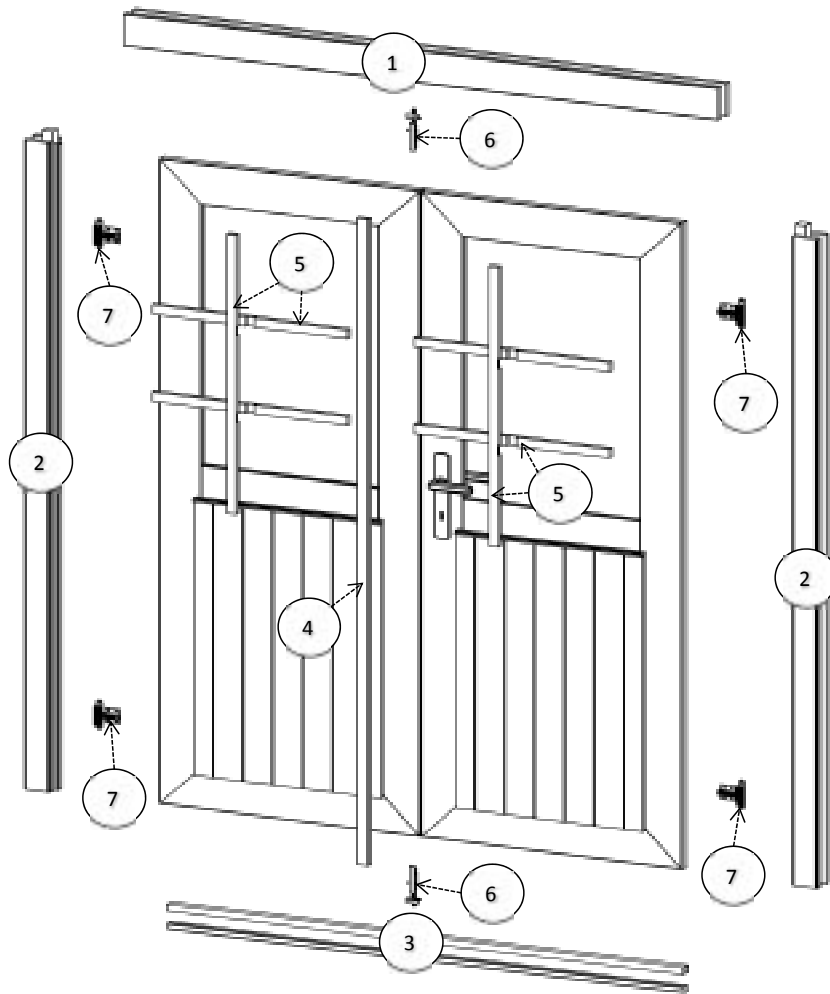

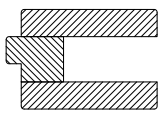
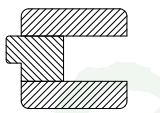
Detail Tür Paris A

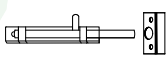
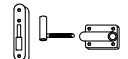

Pos	Piece list - Stückliste - Liste des pièces	Q.	P (mm)
1		1	66x100
2		2	66x80
3		1	19x20
4		1	13x32
5		6	15x25
6		2	
7		4	

Detail Tür Paris A

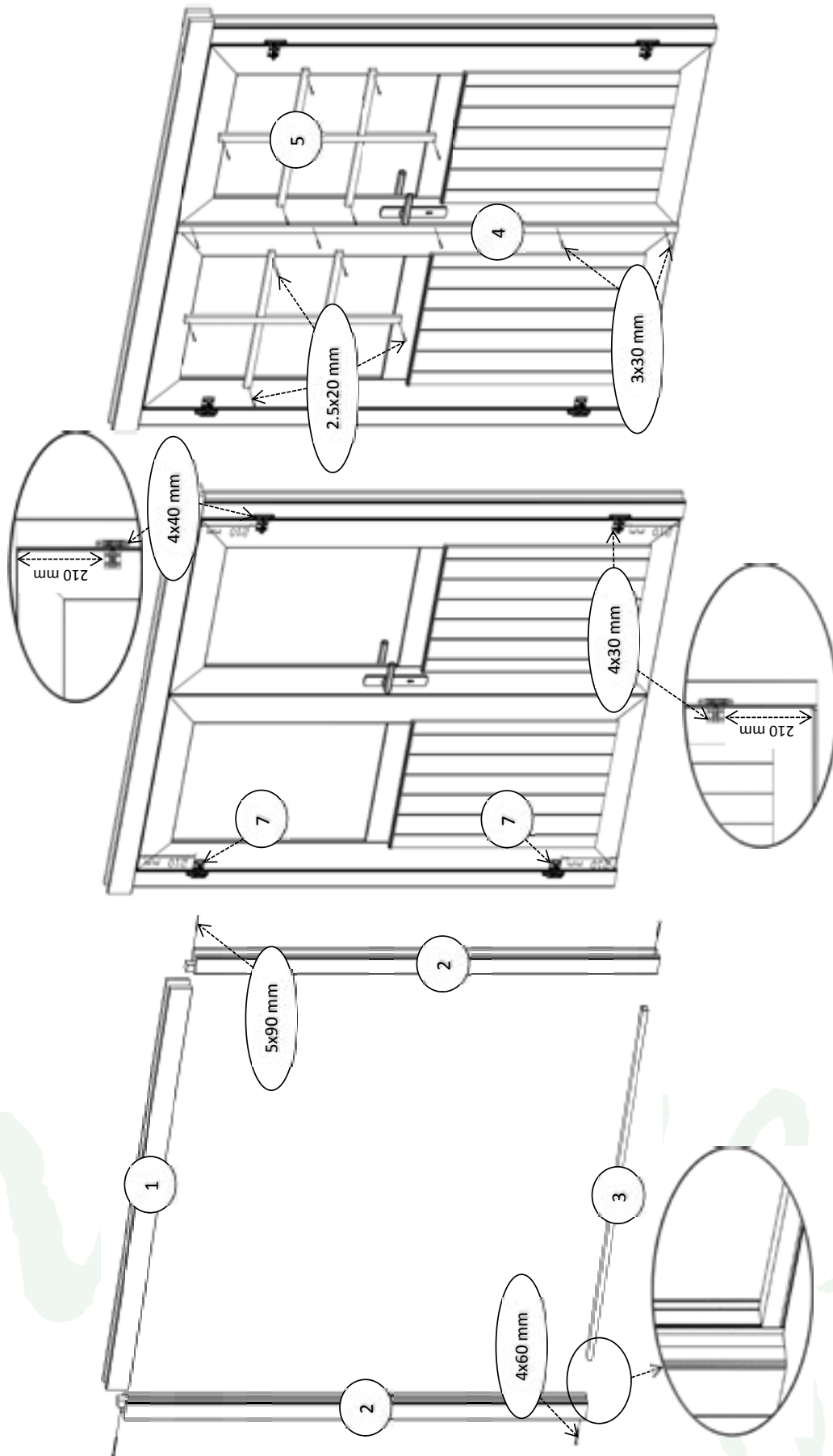

Detail Tür Paris A

