

Pos.	Artikel-Nr.	PG	Bezeichnung	Stk.
1	665877-6	13	ANSCHLUSSLEITUNG	1
2	682516-3	6	KNICKSCHUTZ 9.3-85	1
3	266326-2	1	SCHRAUBE 4x18	2
4	687124-5	1	KABELKLEMMPLATTE	1
5	654531-7	11	LUESTERKLEMME 1P	1
6	645200-1	10	KONDENSATOR	1
7	646056-5	12	DROSSEL	1
8	646090-5	3	DROSSEL	1
9	650642-6	16	MIKROSCHALTER	1
10	210030-5	8	RILLENKUGELLAGER 627ZZ	1
11	187052-9	30	GEHAEUSE-SET INKL. 41, 43	1
11,1	931202-6	1	MUTTER M5	2
12	621753-4	27	FELD 220-240V	1
13	191962-4	19	KOHLEBUERSTEN CB-419	1
14	643923-5	4	KOHLEBUERSTENHALTER	2
15	515824-6	34	ANKER 240V	1
16	452677-1	7	SCHALTHEBEL A	1
17	452680-2	5	SCHALTHEBEL C	1
18	650642-6	16	MIKROSCHALTER	1
20	452681-0	7	SCHALTHEBEL	1
21	326034-8	19	SPINDEL	1
22	262570-9	1	NYLONHUELSE 5	2
23	140830-8	38	SCHERBLATT KPL. 48cm	1
24	253777-8	2	SCHEIBE 8	1
25	214064-0	9	GLEITLAGER 8	1
26	227745-7	14	STIRNRAD 67	1
27	140828-5	17	LAGERGEHAEUSE KPL.	1
28	423417-4	1	FILZDICHTUNG	1
29	211062-5	19	RILLENKUGELLAGER 6000ZZ	1
30	268136-3	1	STIFT 4	1
31	452678-9	14	SCHALTBUEGEL	1
32	233156-6	1	DRUCKFEDER 5	1
33	452682-8	18	BUEGELGRIFF	1
34	911243-8	1	KOMBI-SCHRAUBE M5x25	2
35	140829-3	16	HANDSCHUTZ	1
36	266326-2	1	SCHRAUBE 4x18	2
37	266326-2	1	SCHRAUBE 4x18	14
38	268136-3	1	STIFT 4	1
39	253777-8	2	SCHEIBE 8	1
40	233156-6	1	DRUCKFEDER 5	1
41	187052-9	30	GEHAEUSE-SET INKL. 11, 43	1
41,1	931202-6	1	MUTTER M5	2
42	869253-8	2	TYPENSCHILD UH4861	1
43	892589-0	1	FIRMENSCHILD	1

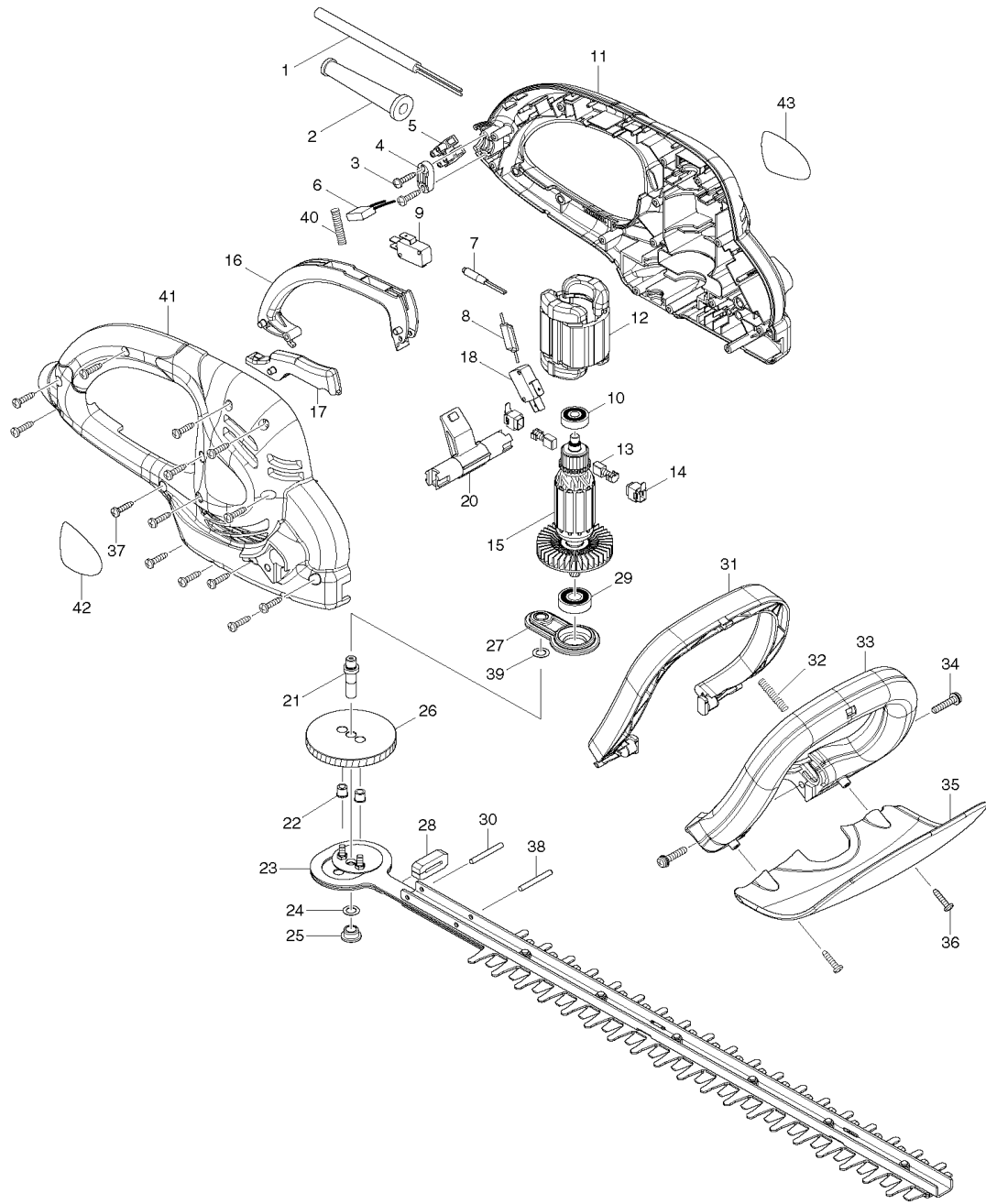

Pos.	Artikel-Nr.	PG	Bezeichnung	Stk.
*** ZUBEHÖR ***				
Z	194677-2		ZULEITUNGSSICHERUNG	1
Z	158024-1	4	KABELHALTEHAKEN	1
Z	452684-4		AUFBEWAHRUNGSBEHAELTER	1