

Lüttich B

Wandaußenmaß: 270 x 200 cm

Bohlenstärke: 28 mm



Kontrolliert durch:

Achtung: Alle angegebenen Maße sind ca.-Maße!

3D-Darstellung und Grundriss Lüttich B

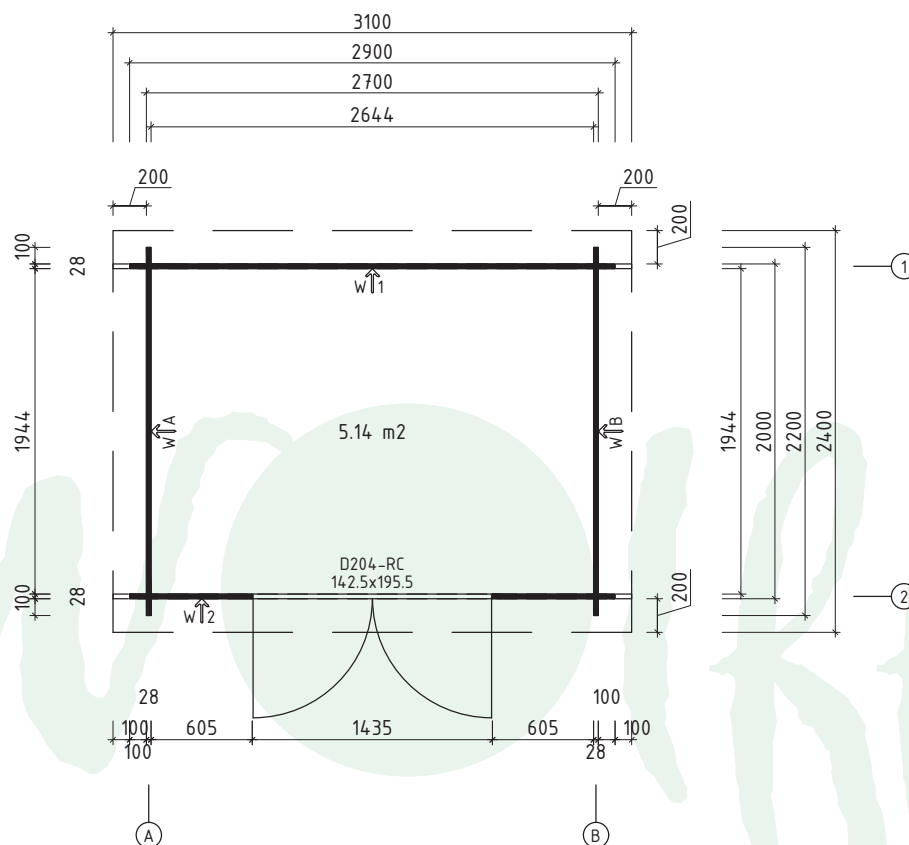
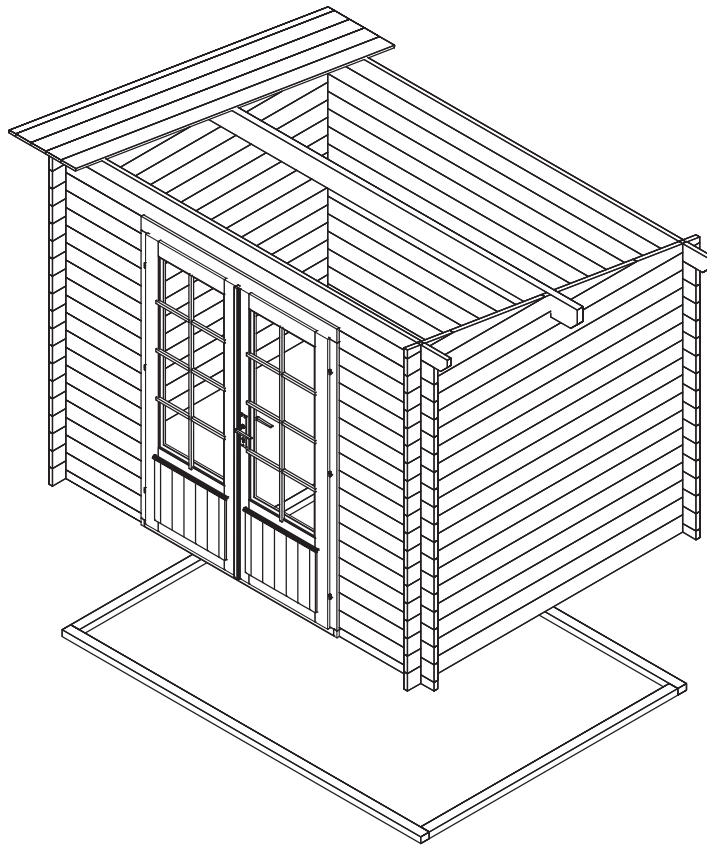

* Fenster und Türen sind mit Sprossen





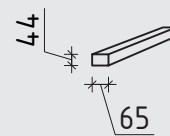
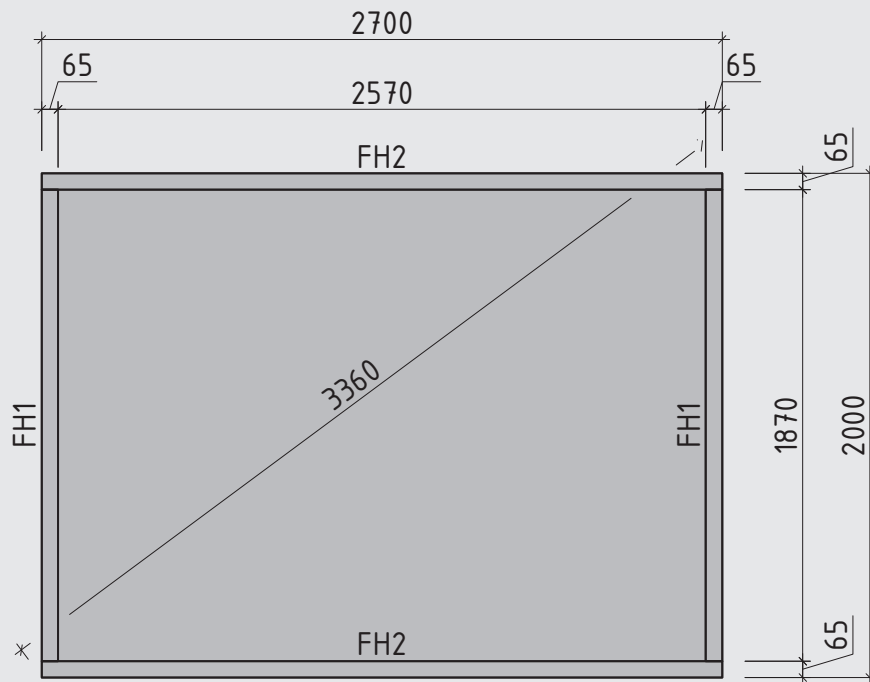





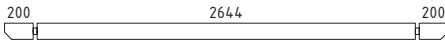
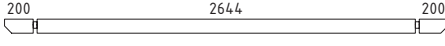
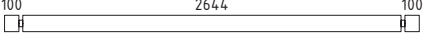
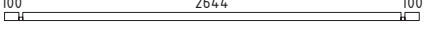
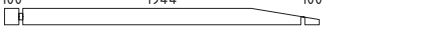
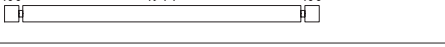



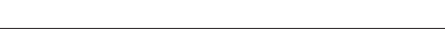

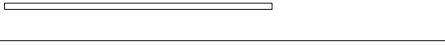
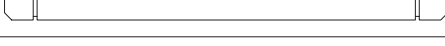
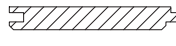
Fundamentplan Lüttich B

Wir empfehlen als Fundament für Ihr Gartenhaus eine vollflächig festgegründete, gepflasterte oder betonierte Fläche.
Wahlweise ist auch ein Punkt- oder Streifenfundament möglich.

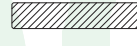



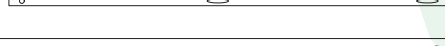

Teileliste 1

Lüttich B

Pos		Stck	Profil (mm)	Länge (mm)
001		1	28x114	3100
002		1	28x97	3100
003		16	28x114	2900
004		1	28x57	2900
005		2	28x114	2200
006		32	28x114	2200
007		2	28x114	1727
008		2	28x114	1036
009		34	28x114	733
010		2	28x57	733
011		2	28x57	345
FH2	FUNDAMENTHÖLZER (imprägniert) 	2	65x44	2700
FH1	FUNDAMENTHÖLZER (imprägniert) 	2	65x44	1870
PF1	PFETTEN 	1	44x145	3100
	DACHBRETTER 	28+1	113x16	2430
G02-1	GIEBELBRETTER 18x120 	2	18x120	2450
G05-1	GIEBELDECKLEISTEN 18x40  ✓	2	18x40	2430
T02-1	TRAUFBRETTER 18x120 	1	18x120	3136
T01-1	TRAUFBRETTER 18x90 	1	18x90	3100
T04-1	TRAUFENDECKLEISTEN 18x40 	1	18x40	3136
T06-1	TRAUFENLEISTEN 18x40  ✓		18x40	7,0 lfdm
SM-1	Sturmleisten 	2	18x40	1770
SM-2	Sturmleisten 	2	18x40	2110
SH	Schlaghölzer 	3		

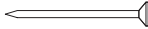
Teileliste 2

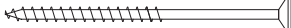
Lüttich B

Pos				Stck.	Profil (mm)	Länge (mm)
NG04	NÄGEL 2.5x50	Dachbretter		168		
SR32	SCHRAUBEN 3.0x30	Traufenleiste 40x18		14		
SR37	SCHRAUBEN 3.5x45	Giebeldeckleisten, Giebelbretter Traufenbretter, Traufendeckleisten		45		
SR57	SCHRAUBEN 5.0x100	Fundamenthölzer		16		
	 <p>TÜR 1425x1955 D204-RC DIN rechts</p>			1		

Wandplan 1 und 2 Lüttich B

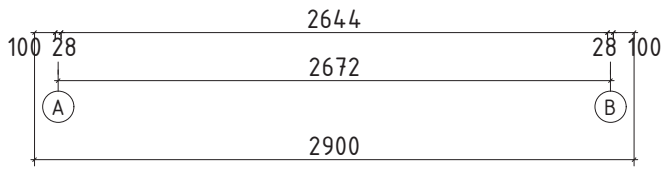
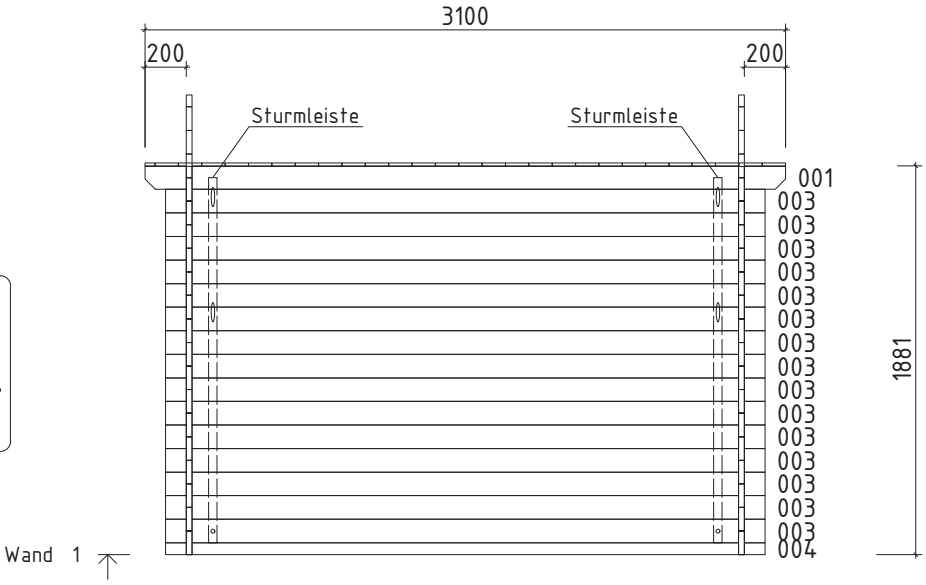
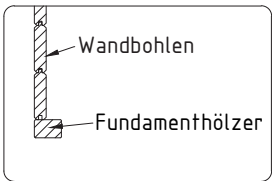
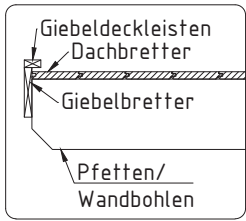

Wand 1

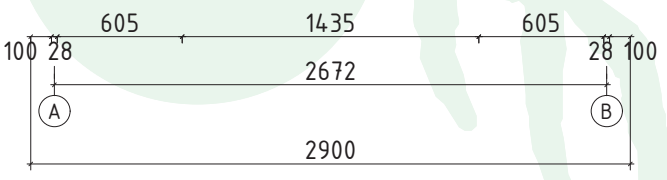
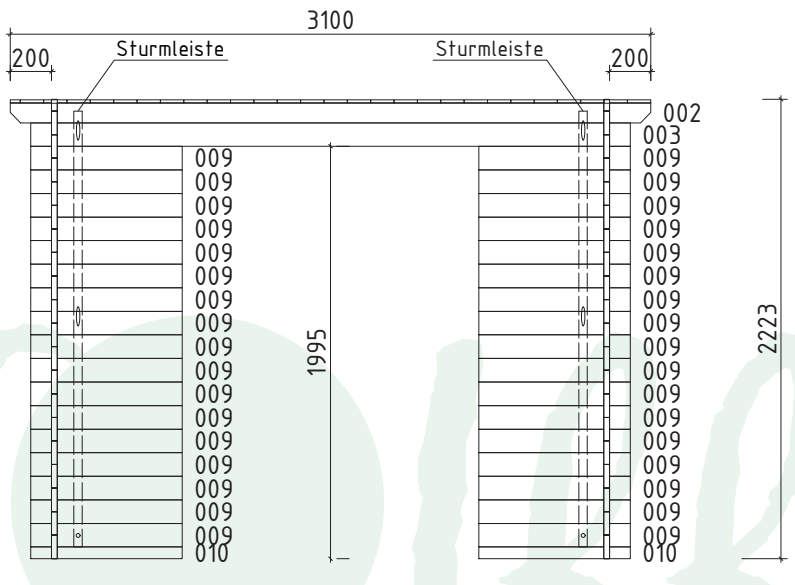

Wand 2

Wandplan A und B

Lüttich B

