

Technische Daten

Lille B

Wandaußenmaß: 450 x 290 cm

Bohlenstärke: 40 mm



Kontrolliert durch:

Achtung: Alle angegebenen Maße sind ca.-Maße!

3D-Ansicht Lille B

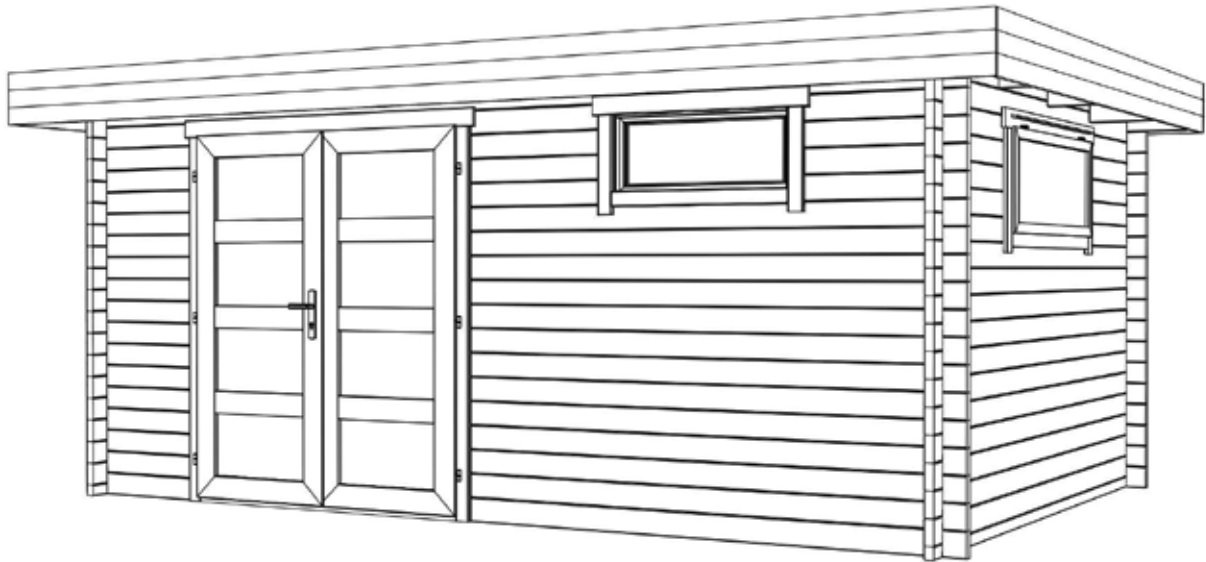

Grundriss Lille B

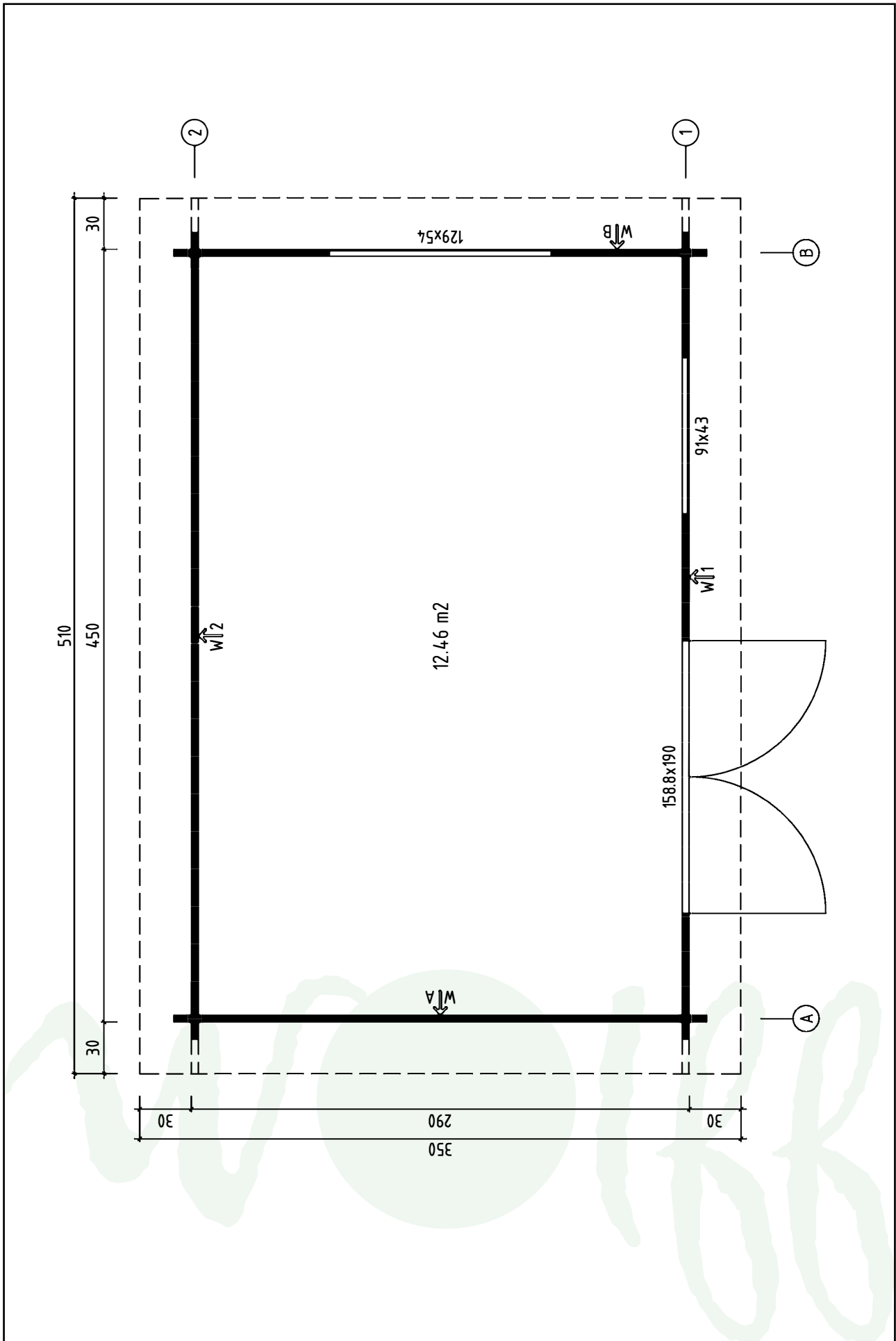



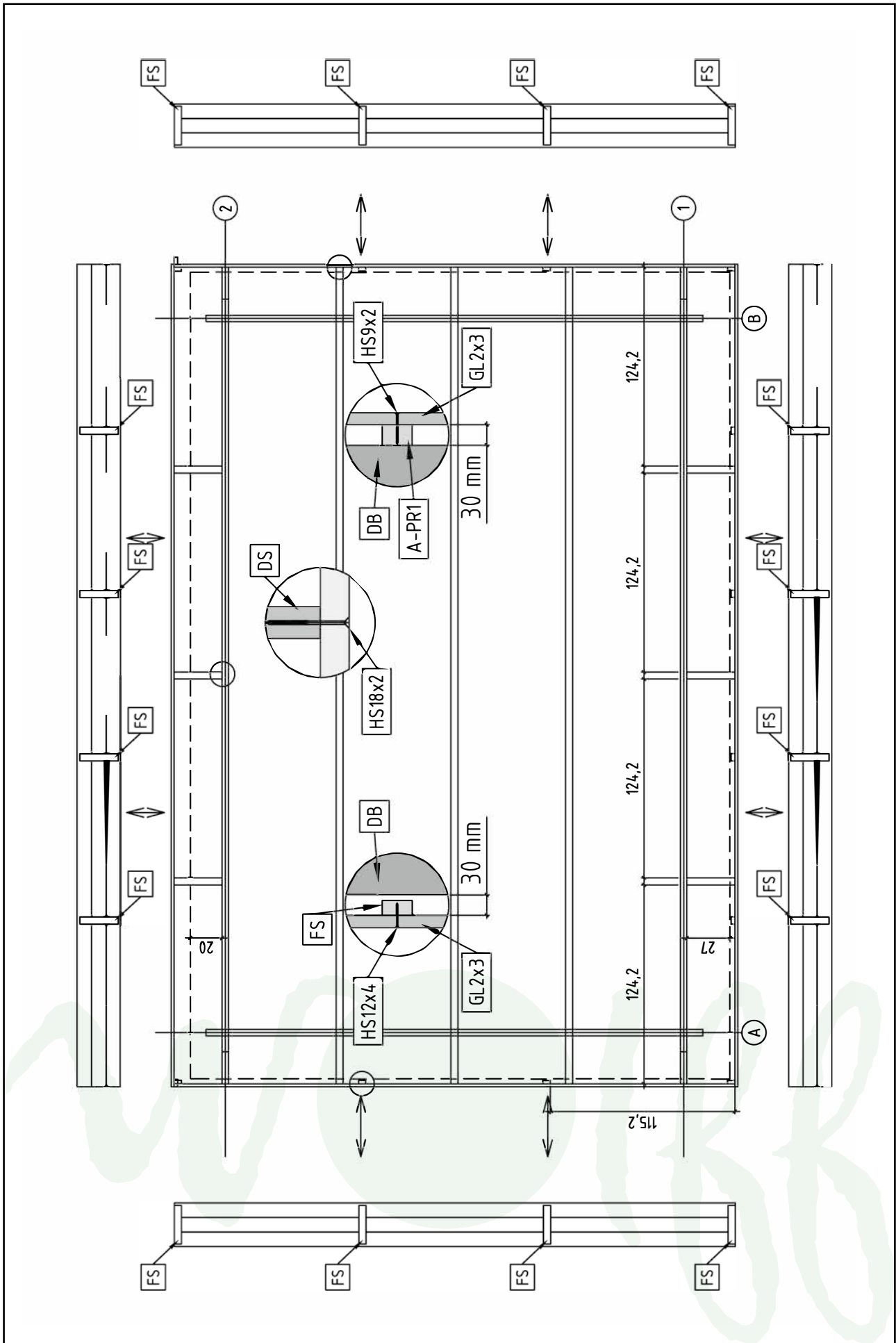



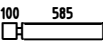
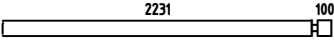
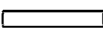
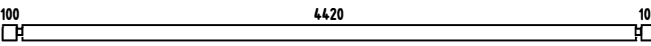
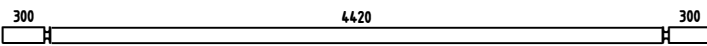
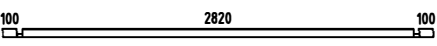
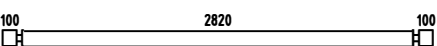
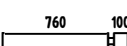
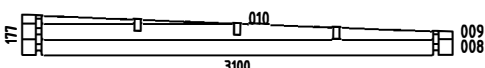
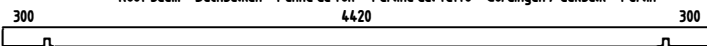
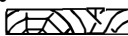
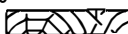

Dach-Draufsicht Lille B



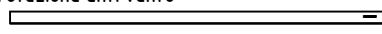
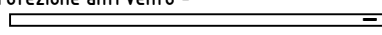

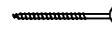

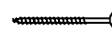

Teileliste 1

Lille B

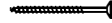
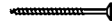
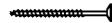
Pos		Q	P (mm)	L (mm)
001		21	40x114	725
002		13	40x114	2371
003		4	40x114	725
004		18	40x114	4700
005		2	40x114	5100
006		2	40x57	3100
007		27	40x114	3100
011		10	40x114	900
WA-1 WB-1		1 1		
A-PR1	Roof beam - Dachbalken - Panne de toit - Perlina del tetto - Gordingen / dakbalk - Pärllin 	3	44x140	5100
GL1	Gable moulding - Giebelleiste - Planche de rive - Finitura per frontale e retro del tetto - Gevellijst - Viilulaud 	6	18x90	5136
GL2	Gable moulding - Giebelleiste - Planche de rive - Finitura per frontale e retro del tetto - Gevellijst - Viilulaud 	6	18x90	3500
DPL1	Roofing felt fillet - Dachpappenleiste - Baguette de fixation du feutre bitumeux - Asse per fissaggio guaina bituminosa - Afdekljst asfaltpapier - Katusepapiilist 	2	18x58	2520
DPL2	Roofing felt fillet - Dachpappenleiste - Baguette de fixation du feutre bitumeux - Asse per fissaggio guaina bituminosa - Afdekljst asfaltpapier - Katusepapiilist 	2	18x58	3312
DB	Roof boards - Dachbretter - Voliges - Perlina per tetto - Dakhout - Katuselaud 	56	90x18	3373
DRV-1	Roof edge reinforcement - Dachrandverstärkung - Corniere de renfort de bord de toit - Rinforzo x tetto - Dakrand versterking - Räästatugevdus 	2	28x34	2520
KFS-1	Storm protection - Sturmleiste - Latte anti-tempete - Protezione anti vento - Stormverankerung / beveiliging - Tormikinnusliist 	2	22x45	2050
KFS-2	Storm protection - Sturmleiste - Latte anti-tempete - Protezione anti vento - Stormverankerung / beveiliging - Tormikinnusliist 	2	22x45	2500
FS	Fixing slat for gable moulding - Befestigungsleiste - Renforts planches de rives - Stecca per fissare i distanziatori - Bevestigingslat afstandhouders - Viilulaua kinnitus 	18	22x45	240
DS	Distance spacers for gable moulding - Dachstützen - Supports extension toiture - Distanziatori per la modanatura del timpano - Daksteun / afstand houder - Viilulaua tugiklots 	6	44x95	300
HS8	Screw for gable moulding fixing slat - Schrauben für befestigungs - leiste - Vis de fixation renforts planches de rives - Viti per distanziatore della stecca di fissaggio - Schroef voor afstand houder lat - Kruvi viilulaua kinnitusele 	120	3.5x35	
HS9	Screw for gable moulding - Schrauben für giebelleiste - Vis pour fixation planche de rive - Vite per fissare finiture davanti e dietro del tetto - Schroef voor gevellijst - Kruvi viilulauale 	32	3.5x50	
HS12	Screw for roof edge reinforcement - Schrauben für dachrandverstärkung - Vis pour fixation corniere renfort de bord de toit - Viti x rinforzo bordo tetto - Schroef voor dakrand versterking - Kruvi räästatugevdusele 	12	4x40	

Teileliste 2

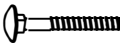
Lille B

Pos		Q	P (mm)	L (mm)
HS18	Screw for roof beams - Schrauben für dachbalken - Vis pour fixation pannes de toit - Viti per perline del tetto - Schroef voor gordingen / dakbalken - Kruvi pärlinitele 	6	5x120	
HS18	Screw for gable - Schrauben für giebel - Vis pour fixation des pignons - Viti per timpano - Schroef voor gevelpunt - Kruvi viilude kinnitamiseks 	8	5x120	
HS16	Screw for fixing gable moulding distance spacers to the wall - Schrauben für dachstützen - Vis de supports extension toiture - Viti x fissaggio fascioni - Schroef voor bevestiging gevelpunt afstandhouder tot wand - Kruvi viilulaudade distantklotsi kinnitamiseks seinale 	12	5x90	
SH40	Hammer block - Schlagholz - Calle de frappe - Blocco di legno da usare come cuscinetto quando si usa il martello - Slagklos - Löögiklots 	1		
SFS	Nut for storm protection - Schraubenmutter für sturmleiste - Ecrou pour latte anti-tempete - Dado x asta protezione vento - Moer voor stromverankering - Mutter tormikinnitusliistule 	8	D6	
NF4	Zn nail for roof - Zn nägel für dachbretter - Pointe pour fixation voliges de toit - Chiodi x perline tetto - Spijker(nagel) voor dakhout - Nael katuselauale 	293	2x50	
NF5	Zn nail for roofing felt fillet - Zn nägel für dachpappeneleiste - Pointe pour baguette de fixation feutre bitumeux - Chiodi x carta bituminosa x tetto - Spijker(nagel) voor asfaltpapier afdeklijst - Papiliistunael 	28	2x40	
BFS	Bolt for storm protection - Bolzen für sturmleiste - Boulon pour latte anti-tempete - Bullone x asta protezione vento - Bout voor stormankerlat - Puidupolt tormikinnitusliistule 	8	6x70	
DFS	Washer for storm protection - Dichtscheibe für sturmleiste - Rondelle pour latte anti-tempete - Rondella x asta protezione vento - Afdichtring voor storm strip - Seib tormikinnitusliistule 	8	D6	
	Window - Fenster - Fenetre - Finestra - Raam - Aken 910x430 AK.1.100.MSV.f MGC	1		
	Window - Fenster - Fenetre - Finestra - Raam - Aken 1290x540 AK.1.100.MVA.c MGC	1		
	Door - Tür - Porte - Porte - Deur - Uks 1588x1900 TUK.4.020.MVV.MMb MGC	1		



Fensterdetails

Lille B

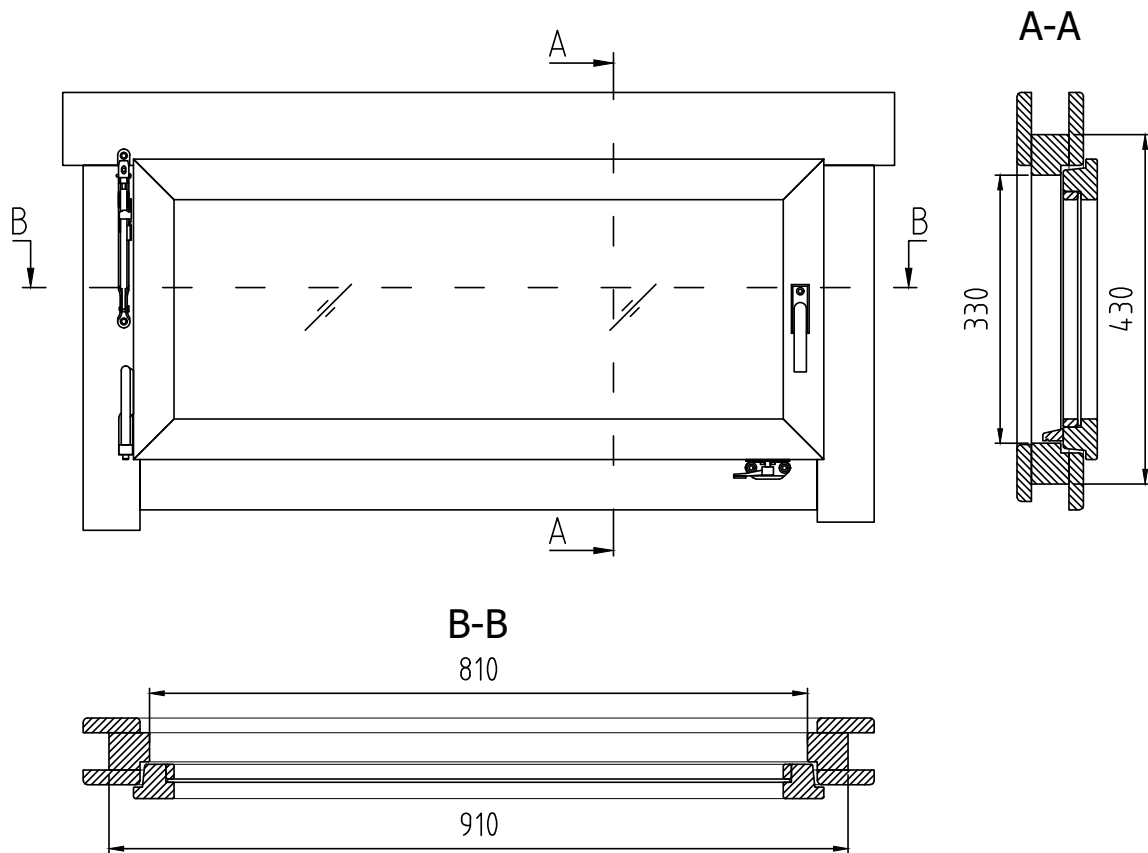
Milklass size - Milchglasgröße - Taille de la vitre - Misura del vetro -
Glas afmeting - Klaasi mõõt: 766x266 mm

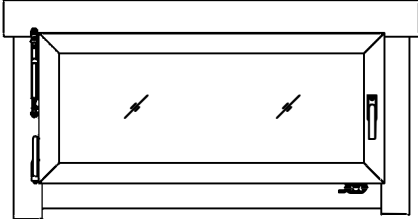
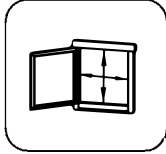

Teileliste Fenster Lille B

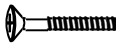
Pos		P (mm)	L (mm)
	<p>Glass size - Glasgröße - Taille de la vitre - Misura del vetro - Glas afmeting - Klaasi mõõt: 766x286 mm</p>   <p>810x330 mm</p>		
FS1	<p>Window handle fittings - Fenstergriff - Poignee de fenetre - Maniglia c/ferramenta - Raamhendel -/grendel -/klink - Aknalink</p> 	1	
FSP	<p>Bolt for window handle fittings - Bolzen für fenstergriff beschlag - Vis pour fixation poignee de fenetre - Bullone x apertura manuale finestra - Schroef voor raamhendel - Akna käepideme polt</p> 	2	

Fensterdetails Lille B

Milklass size - Milchglasgröße - Taille de la vitre - Misura del vetro -
Glas afmeting - Klaasi mõõt: 1146x396 mm

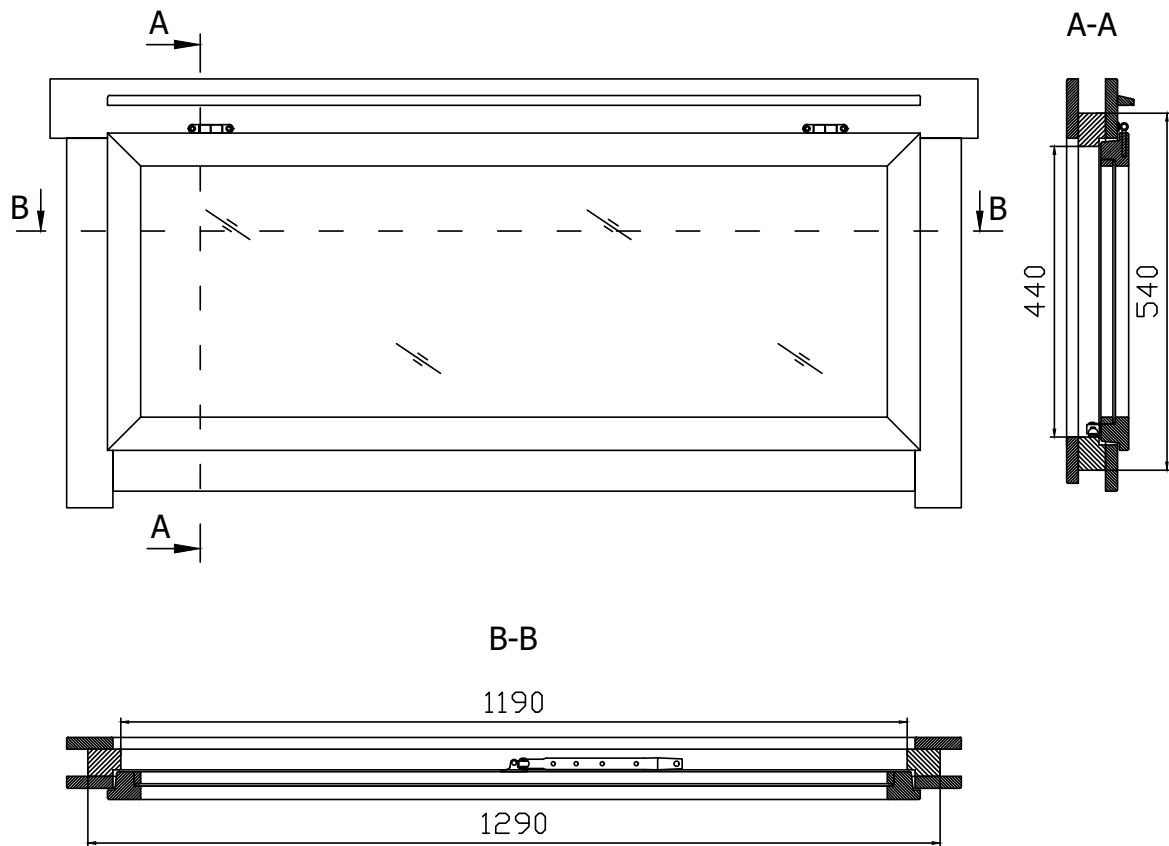

Teileliste Fenster Lille B

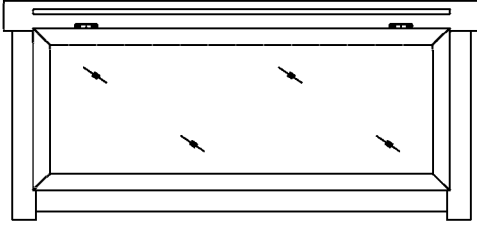
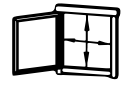





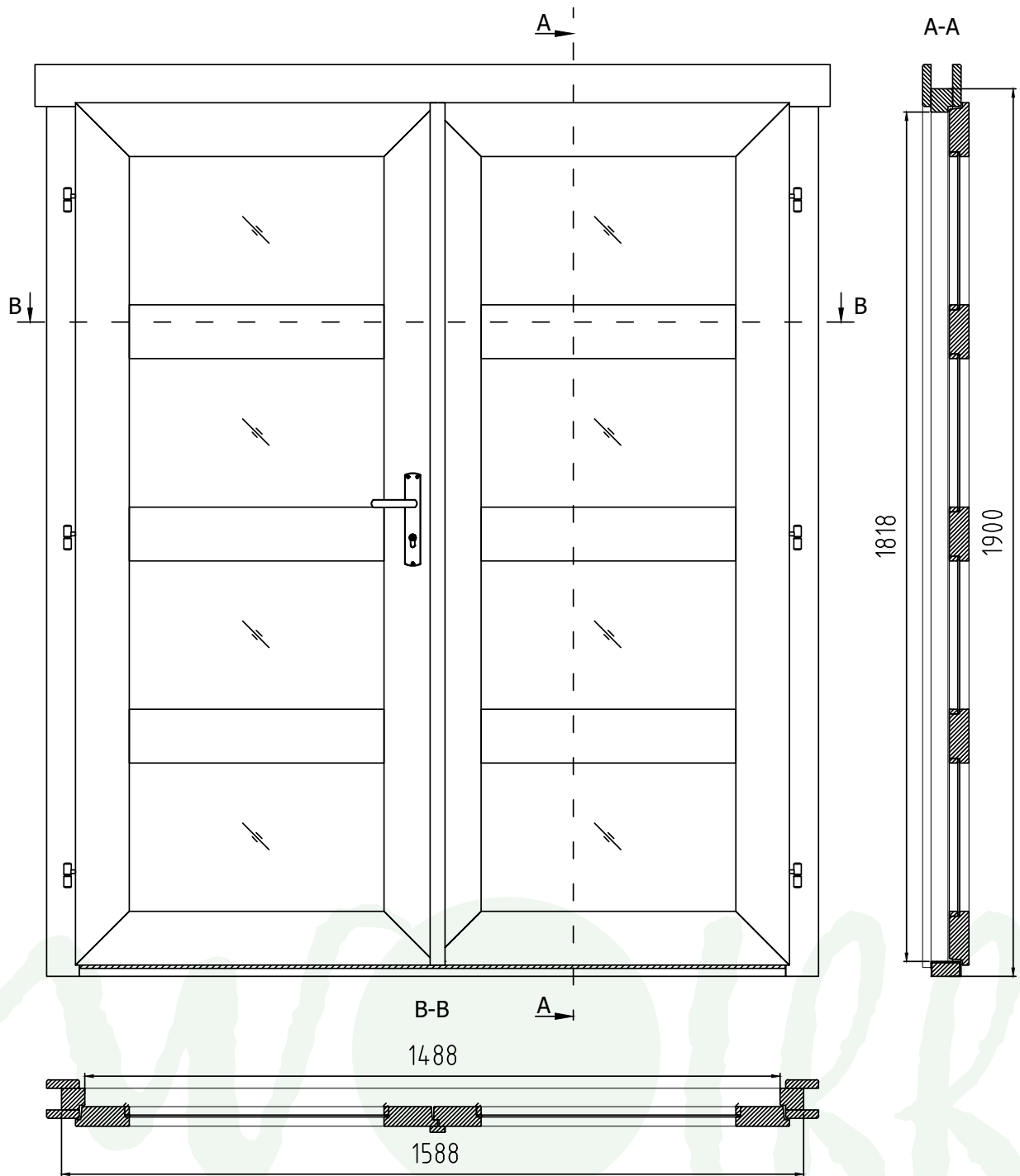

Pos		Q	P (mm)	L (mm)
	<p data-bbox="271 353 1165 385">Glass size - Glasgröße - Taille de la vitre - Misura del vetro - Glas afmeting - Klaasi mõõt: 1146x396 mm</p>  <p data-bbox="1204 358 1364 504"> 1190x440 mm</p>			

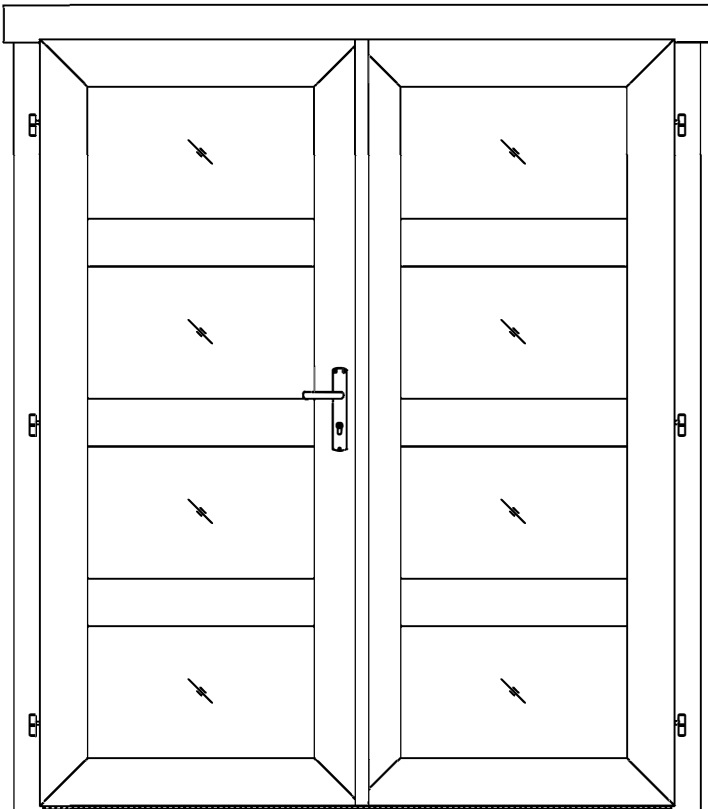
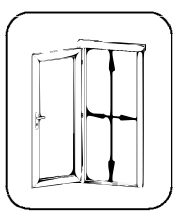
Türdetails Lille B

Milklass size - Milchglasgröße - Taille de la vitre - Misura del vetro -
Glas afmeting - Klaasi mõõt: 561x334 mm

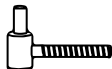

Teileliste Tür Lille B

Pos		Q	P (mm)	L (mm)	
	<p>Glass size - Glasgröße - Taille de la vitre - Misura del vetro - Glas afmeting - Klaasi mõõt: 561x334 mm</p>   <p>1488x1818 mm</p>				
HS4	Screw for door fillet - Schraube zur Befestigung Türleiste - Vis pour fixation baguette d'arrêt de porte - Viti per massellino della porta - Schroef voor deurlijst - Kruvi ukse kokkuvaltssiliistule		5	3x30	
HS16	Screw for door jamb - Schraube für Türrahmen - Vis de fixation partie haute avec montants du cadre de porte - Viti x fissaggio montanti porte - Schroef voor deurkozijn - Kruvi ukse lengile		4	5x90	
HS25	Screw for doorstep - Schrauben für Swelle - Vis pour fixation barre de seuil - Vite per soglia della porta - Schroef voor deurdorpel - Kruvi lävepakule		3	4.5x65	
TL4	Door handle fittings - Türgriff - Poignée de porte - Maniglie - Deurhendel / klink - Ukse käepide		1		
TL5	Set of door lock covers - Schlossblenden - Set de garnitures de porte - Copertura serrature - Slot sluitplaat set - Ukse lukuplaat		1		
	Cylinder lock - Zylinderschloss - Barillet de porte - Serratura - Cylinder slot - Ukse lukusüdamik		1	30x35	
	Male bolt hinge for door - Türband - Partie male de paumelle de porte - Cerniera anube x porta - Scharnier bout - Ukse polthing isane		6		
	Striker for barrel bolt - Hülse für Grendelriegel - Gache au sol du targette - Boccola per fermo della porta - Huls voor vergrendelingsschuif - Vasturaud ukse servariivile		2		

Wandplan Lille B

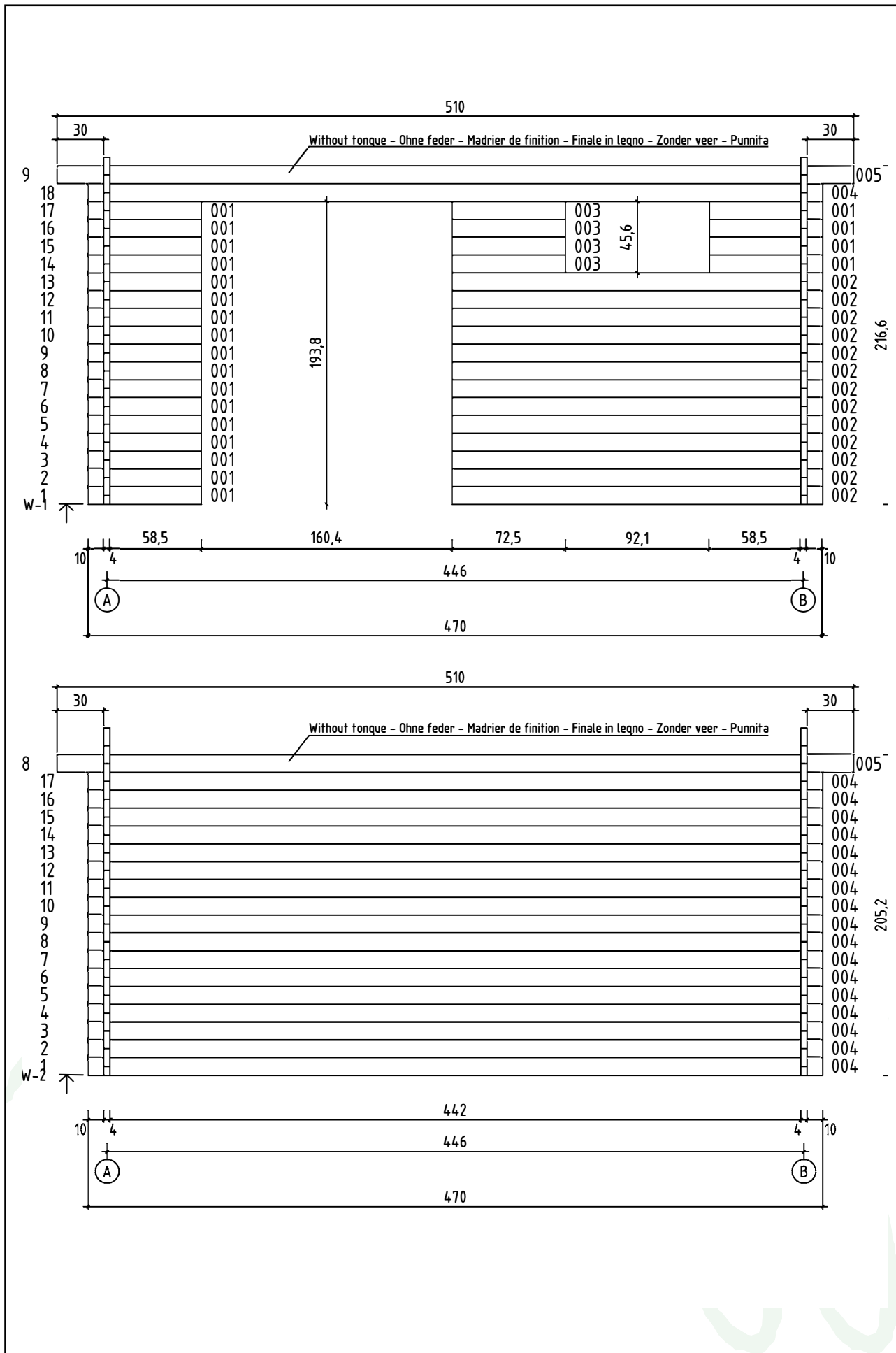

Wandplan Lille B

