

99955 99956

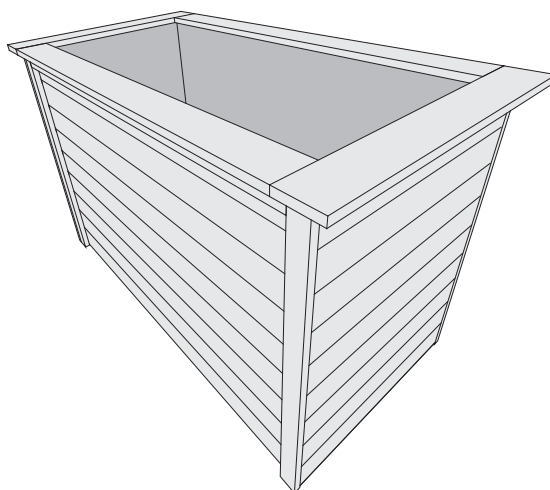

- | | |
|---|--|
|  Innenliegende Folie ist Bestandteil des Bausatzes (Kein Verpackungsmaterial) |  La lámina interior forma parte del kit (sin material de embalaje) |
|  Inner foil is part of the kit (no packaging material) |  La pellicola interna fa parte del kit (senza materiale di imballaggio) |
|  Le film intérieur fait partie du kit (pas de matériel d'emballage) |  Vnitřní fólie je součástí sady (bez obalového materiálu). |
|  Binnenfolie maakt deel uit van de kit (geen verpakkingsmateriaal) |  Notranja folija je del kompleta (brez embalažnega materiala) |
|  Den indvendige folie er en del af sættet (intet emballagemateriale) | |



-  **Aufbauanleitung**
-  **Building Instructions**
-  **notice de montage**
-  **montagehandleiding**
-  **Montagevejledning**
-  **Instrucciones de construcción**
-  **Istruzioni per il montaggio**
-  **Montážní návod**
-  **Navodila za sestavljanje**

Bitte bewahren Sie die Anleitung und den Garantieschein zur Seriennummer auf.





Vernichten Sie diese erst nach Ablauf der Garantiezeit.

Eventuelle Beanstandungen können mithilfe der Stückliste einfacher zugeordnet werden.





Beigelegte Dokumente

- Informationsheft
- Garantieschein zur Seriennummer
- Typenschild inkl. Warnhinweise (Sauna)
- ggf. Zubehör-Anleitungen in externen Paketen





- *  Nicht im Lieferumfang enthalten
 Not included
 Non comprises dans la livraison
 Niet bijgeleverd

-  No forman parte del suministro
 Non incluso
 V ceně není zahrnuto
 Ikke inkluderet

- 1  Länge muss ermittelt und zugesägt werden
 Length must be determined and sawn
 La longueur doit être déterminée et sciée
 De lengte moet worden bepaald en worden gezaagd

-  La longitud debe ser determinada y aserrada
 La lunghezza deve essere determinata e segata
 Délka musí být určena a rozřezána
 Længden skal bestemmes og saves





- 2  Nicht gebraucht
 Not needed
 Pas nécessaire
 Niet nodig

-  No es necesario
 Non necessario
 Není nutná
 Ikke nødvendigt





- 3  Mit Zubehör
 With accessories
 Avec accessoires
 Met toebehoren

-  Con accesorios
 Con accessori
 S příslušenstvím
 Med tilbehør

- 4  Fixiert vorübergehend
 Fixed temporarily
 Temporairement fixe
 Tijdelijk vast

-  Temporalmente fijo
 Temporaneamente fisso
 Dočasně pevný
 Midlertidigt rettet

- 5  Bestand vom Haus
 Inventory of the house
 Inventaire de la maison
 Inventaris van het huis

-  Inventario de la casa
 Inventario della casa
 Inventář domu
 Inventar af huset

 Vergleichen Sie zuerst die Material-liste mit Ihrem Paketinhalt! Bitte haben Sie Verständnis, dass Beanstandungen nur im nicht aufgebauten Zustand bearbeitet werden können!

 Vergelijk eerst de lijst van materialen met de inhoud van uw pakket! Reclamaties kunnen alleen in behandeling worden genomen zolang de onderdelen nog niet zijn gemonteerd!

 Confrontate questa distinta materiali prima con il contenuto del pacchetto! Vi preghiamo di comprendere che eventuali reclami possono essere accolti solo prima del montaggio!

 First compare the list of materials with your package contents! Please understand that complaints can be processed in the non-built status only!

 Start med at kontrollere materialelisten med indholdet af den leverede pakke! Vi gør venligst opmærksom på at reklamationer kun kan behandles for materialer som ikke er blevet bearbejdet!

 Nejprve překontrolujte obsah balení podle materiálového listu! Mějte pochopení pro to, že případnou reklamaci se můžeme zabývat pouze tehdy, když díly nebudou smontované! Za pomoci tohoto seznamu můžete jednotlivé díly přiřadit k montážnímu návodu.

 Commencez par comparer la liste du matériel avec le contenu de votre paquet! Sachez que nous traitons uniquement les réclamations concernant le matériel à l'état non monté!

 En primer lugar, compare la lista de material con el contenido del paquete. Rogamos entienda que las reclamaciones sólo pueden ser tramitadas antes de montar el objeto!

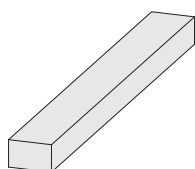

 Najprej primerajte seznam materialov z vsebino vašega paketa! Upoštevajte, da lahko pritožbe obravnavamo le v neseštavljenem stanju!



2 x B1	816 x 45 x 18 mm	ID 99961
8 x B2	800 x 45 x 18 mm	ID 99962
2 x B3	1583 x 45 x 18 mm	ID 99963
2 x B4	967 x 95 x 18 mm	ID 99964
2 x B5	1586 x 95 x 18 mm	ID 99965

18 x R1	870 x 96 x 19 mm	ID 99957
18 x R2	1640 x 96 x 19 mm	ID 99958

1 x	ID 65384
-----	----------

		
180	4 x 35 mm	ID 3687
40	4 x 50 mm	ID 3688

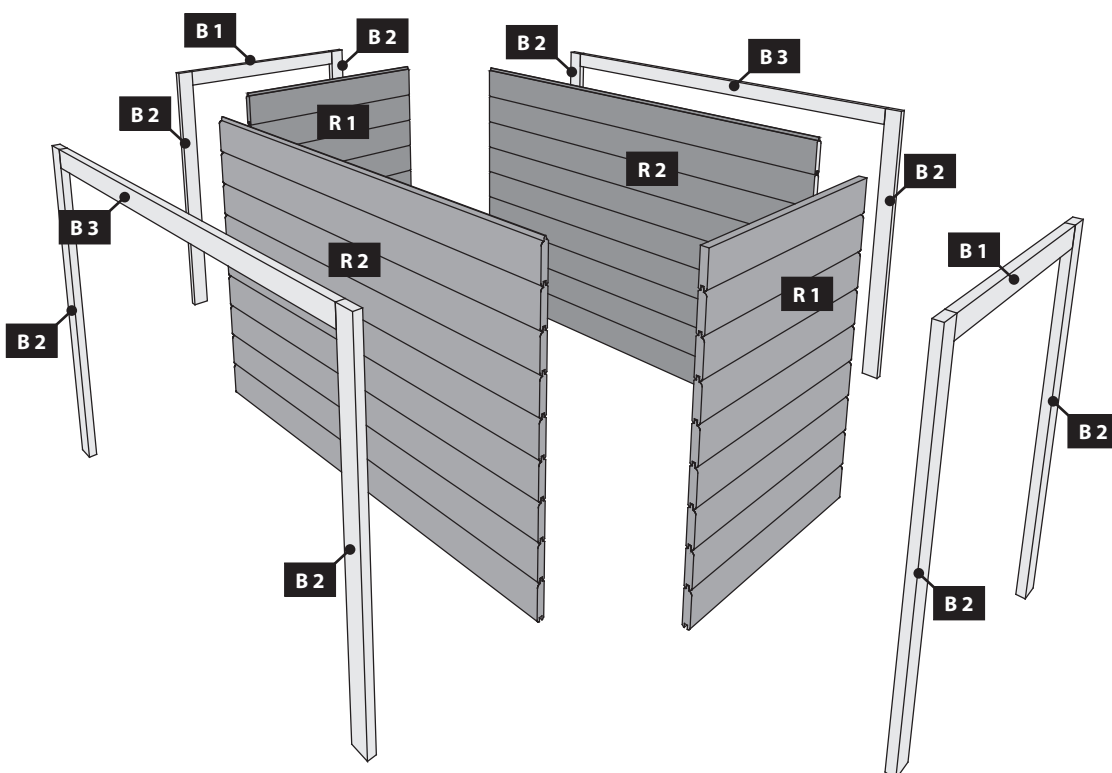
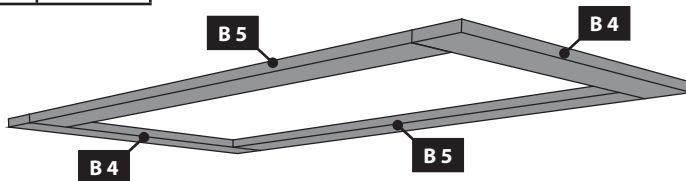

Ø3mm 4x35

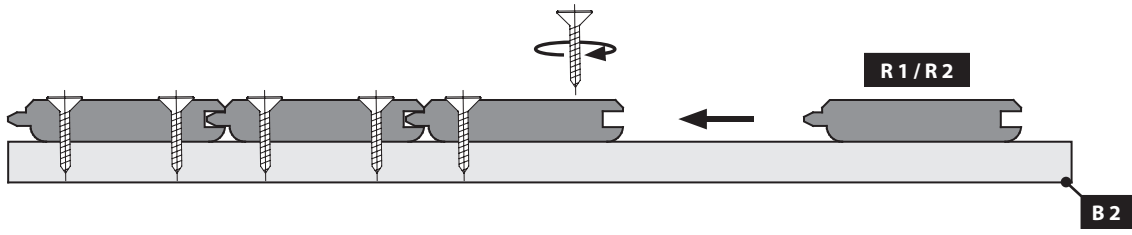
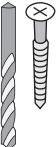

01

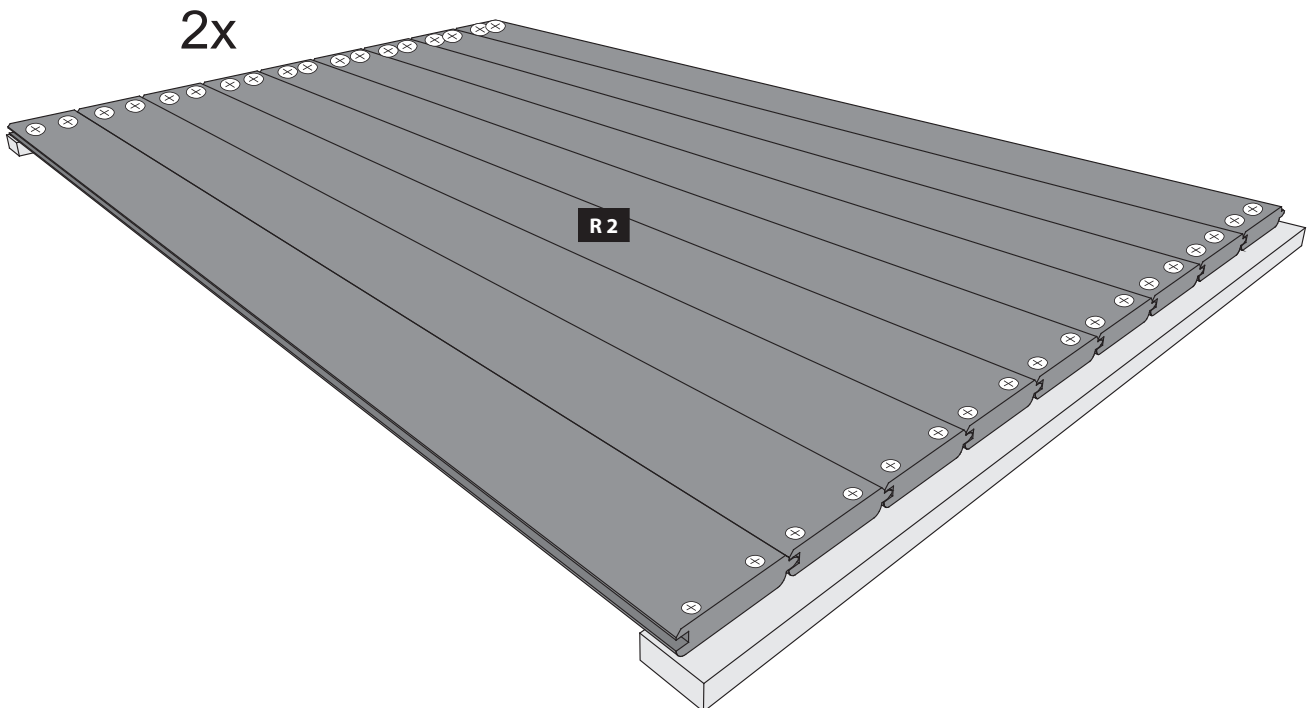
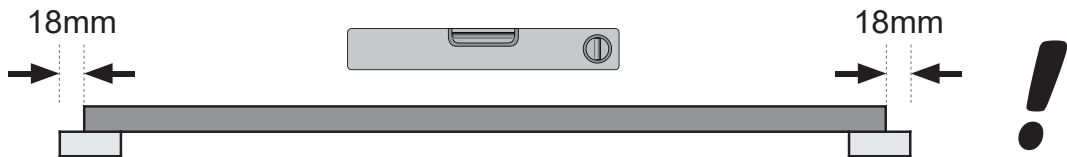
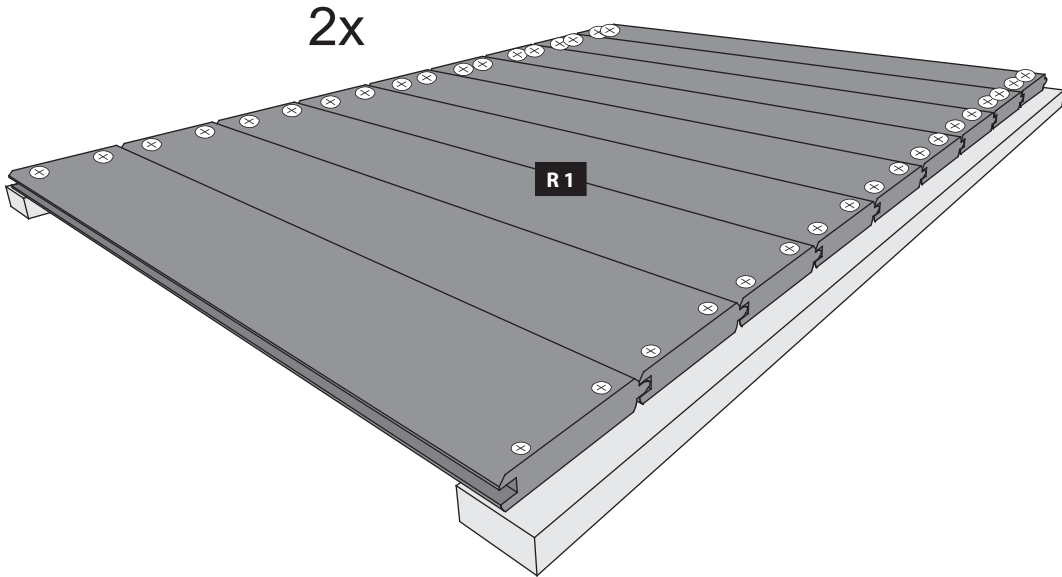

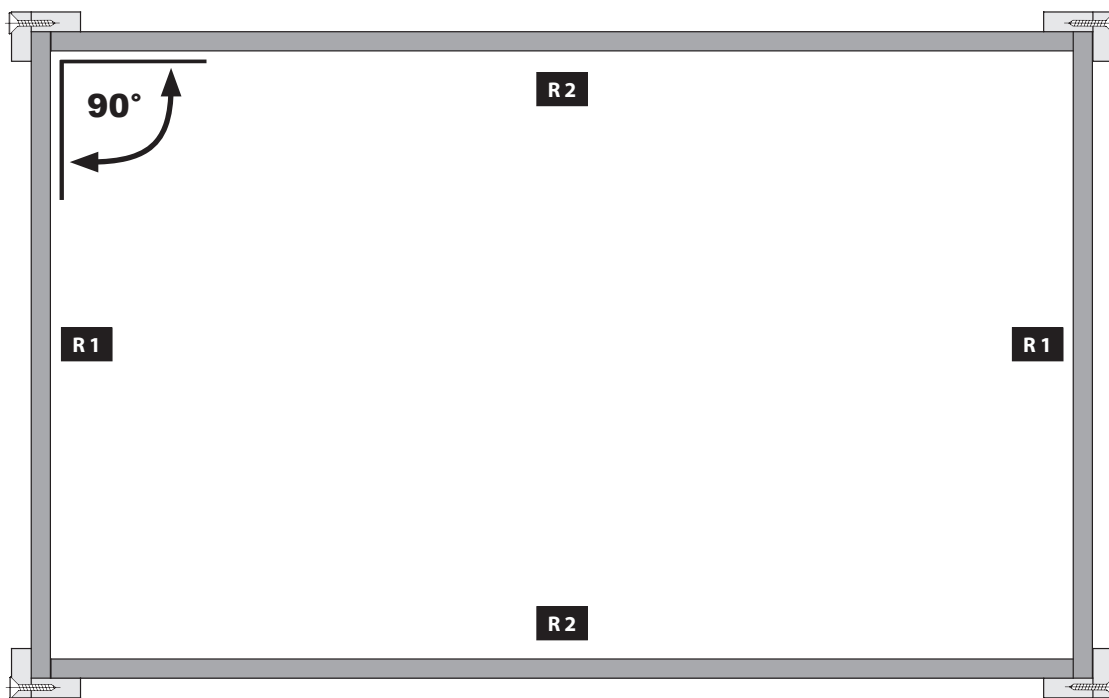
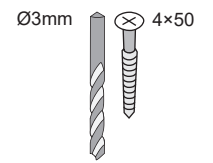
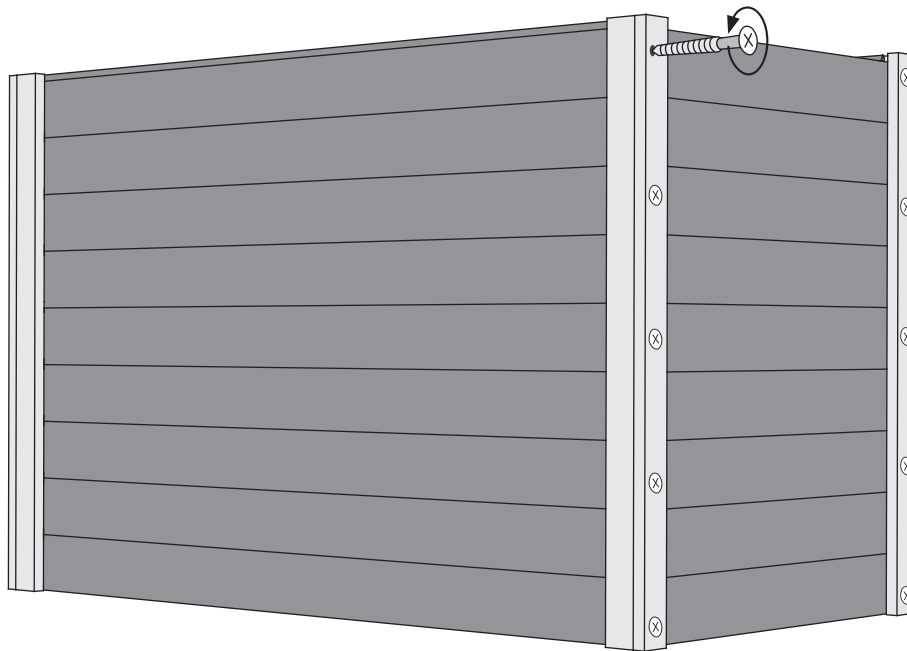

- | | |
|--|---------------|
| | Bündig! |
| | Flush! |
| | Affleurement! |
| | Gelijk! |
| | I flugt! |
| | Aras! |
| | Combacia! |
| | Stejný! |
| | Splakovanie! |

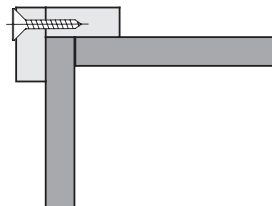

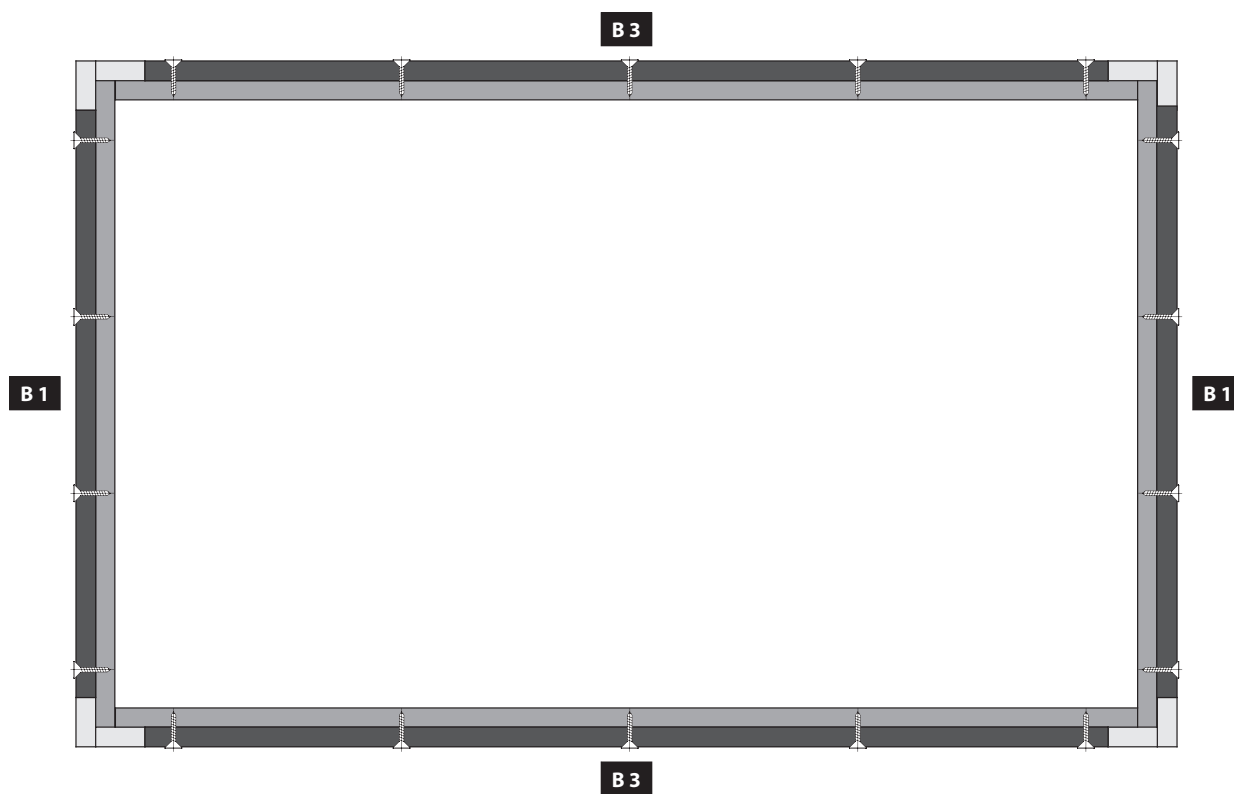
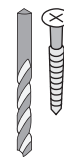
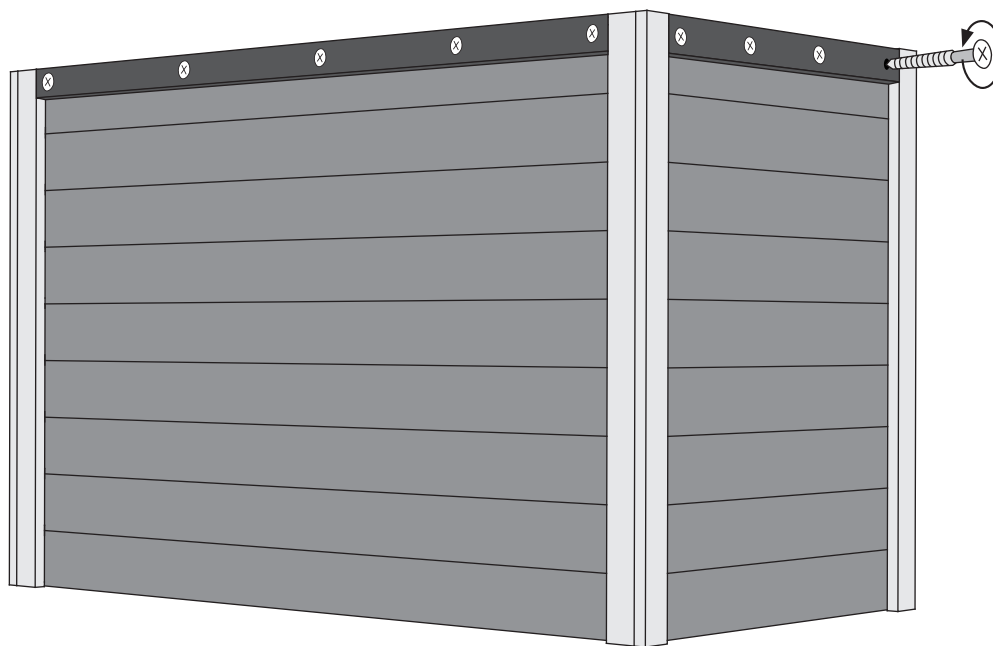

Ø3mm 4x35

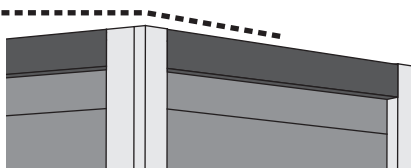

-  Bündig!
-  Flush!
-  Affleurement!
-  Gelijk!
-  I flugt!
-  Aras!
-  Combacia!
-  Stejný!
-  Splakovanje!

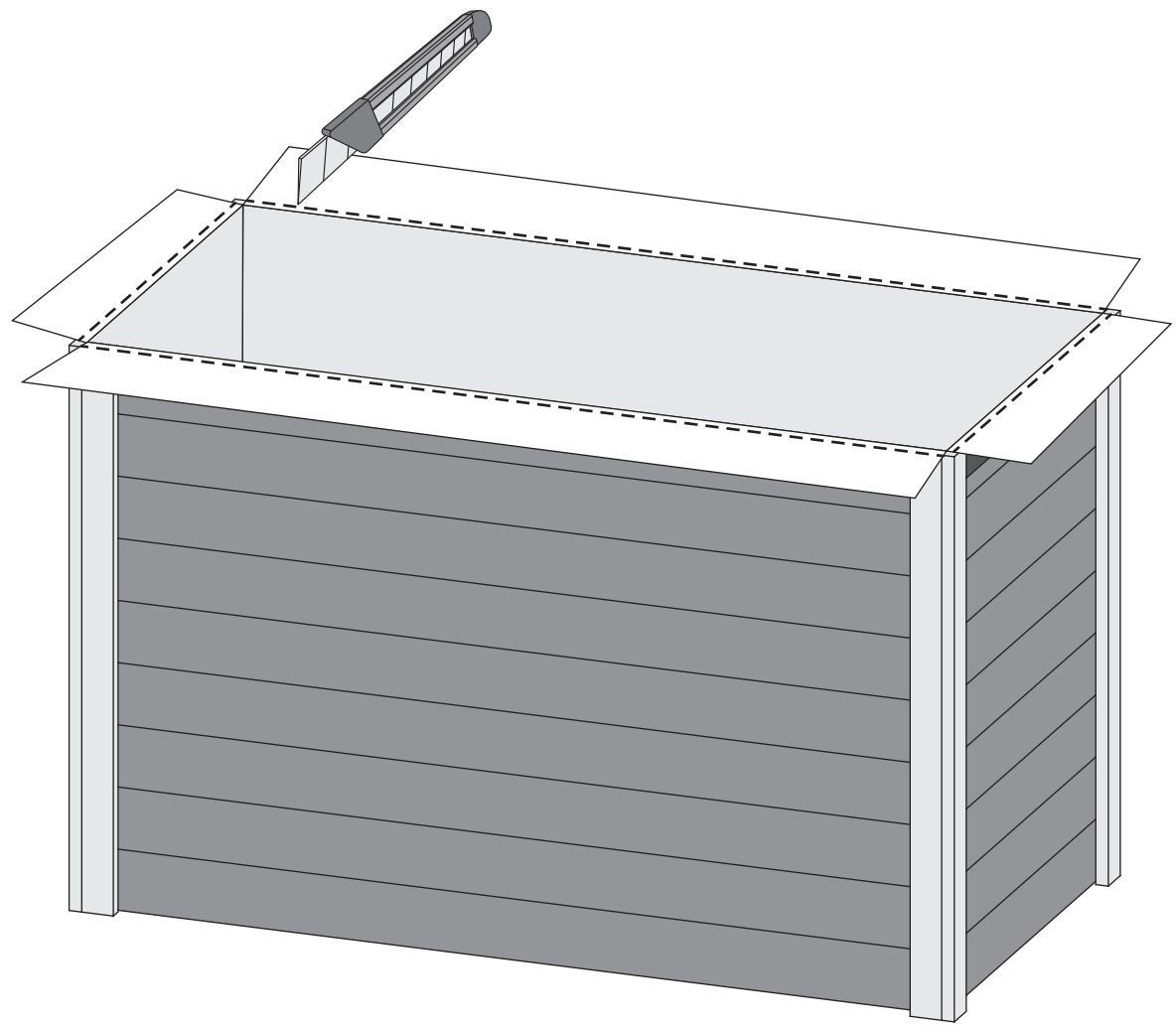
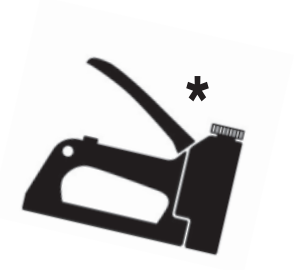
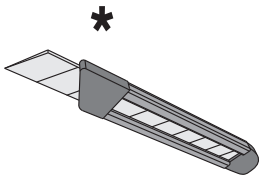



Ø3mm  4x50 

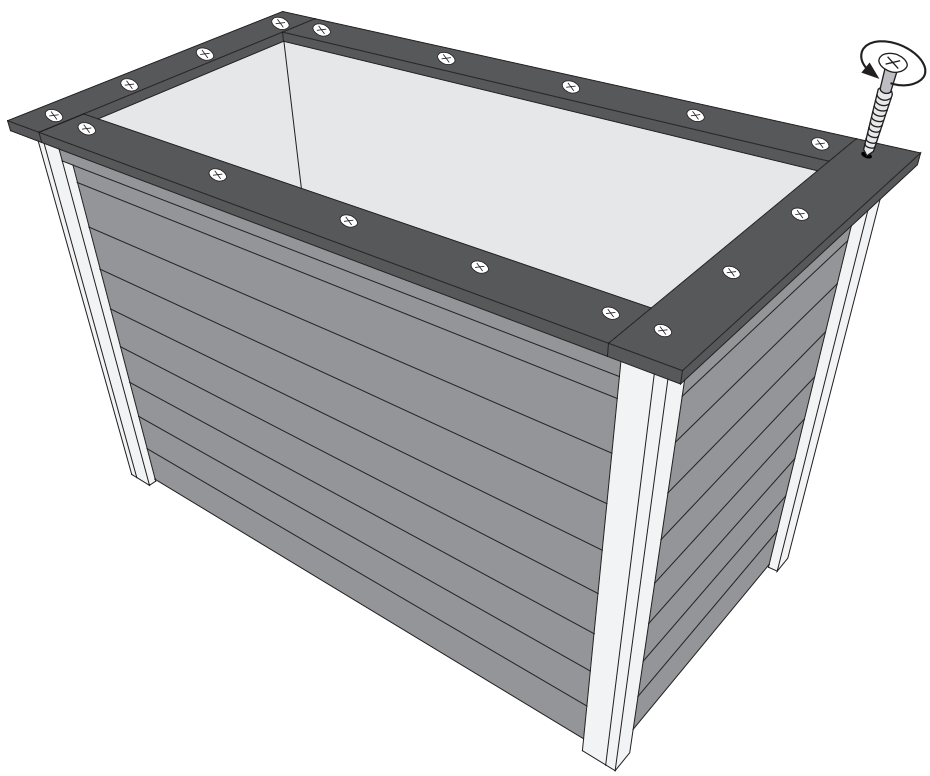

B 5

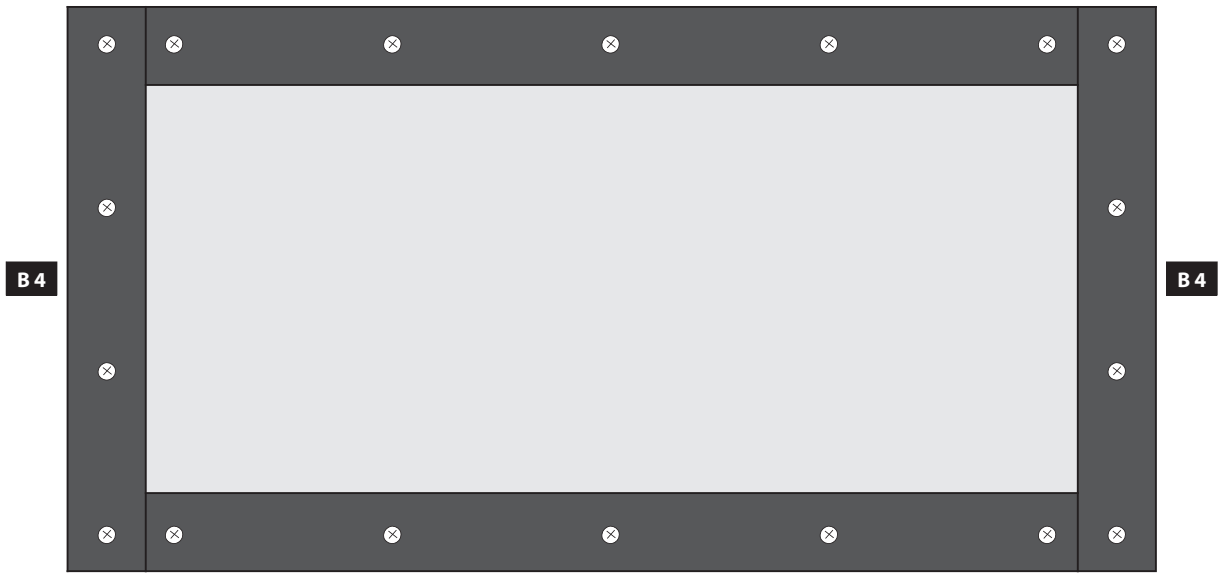



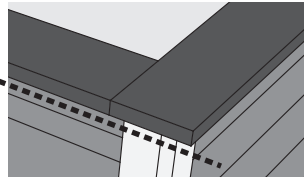

B 5

-  Bündig!
-  Flush!
-  Affleurement!
-  Gelijk!
-  I flugt!
-  Aras!
-  Combacia!
-  Stejný!
-  Splakovanje!



 Hochbeet befüllen
 fill properly
 remplir correctement
 goed invullen

 llenar correctamente
 riempire correttamente
 správně vyplňte
 správne vyplňte

A

B

C

D

 Gartenerde
 Garden soil
 Terreau de jardin
 Tuinaarde
 Tierra de jardín
 Terreno da giardino
 Zahradní půda
 Vrtna zemlja

 Laub
 Foliage
 Feuilles mortes
 Bladeren
 Follaje
 Fogliame
 Listia
 Listje

 Feine Äste
 Fine branches
 Nœuds fins
 Fijne takken
 Ramas finas
 Rami sottili
 Jemné větve
 Drobné veje

 Grobe Äste
 Coarse branches
 Grosses branches
 Grove takken
 Ramas gruesas
 Rami grossi
 Hrubé větve
 Grobe veje

