

# 32414 41838

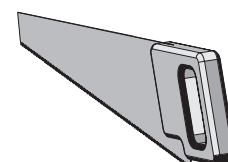
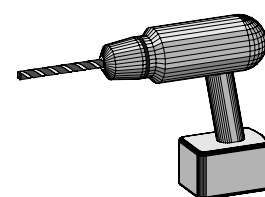
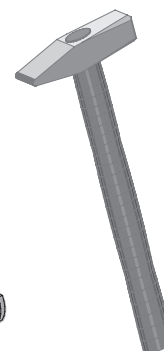
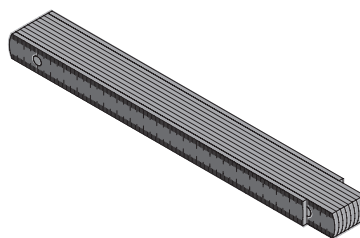
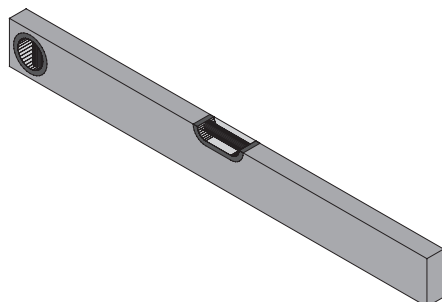

 **Aufbauanleitung**

 **notice de montage**

 **Building Instructions**

 **montagehandleiding**

 **Instrucciones de construcción**

 **Istruzioni per il montaggio**

 **Service-Hotline: +49 421 38693 33**



Vergleichen Sie zuerst die Materialliste mit Ihrem Paketinhalt! Bitte haben Sie Verständnis, dass Beanstandungen nur im nicht aufgebauten Zustand bearbeitet werden können!



Commencez par comparer la liste du matériel avec le contenu de votre paquet! Sachez que nous traitons uniquement les réclamations concernant le matériel à l'état non monté!



First compare the list of materials with your package contents! Please understand that complaints can be processed in the non-built status only!



Vergelijk eerst de lijst van materialen met de inhoud van uw pakket! Reclamaties kunnen alleen in behandeling worden genomen zolang de onderdelen nog niet zijn gemonteerd!



En primer lugar, compare la lista de material con el contenido del paquete. Rogamos entienda que las reclamaciones sólo pueden ser tramitadas antes de montar el objeto!



Confrontate questa distinta materiali prima con il contenuto del pacchetto! Vi preghiamo di comprendere che eventuali reclami possono essere accolti solo prima del montaggio!



# 32414 41838



1 x F1

690 x 796 x 55mm



1 x F2

580 x 682 x 40mm



1 x F3



1 x F4

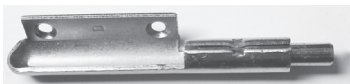

1 x F5

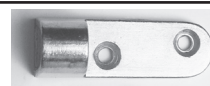

1 x F6



1 x F7



1 x F8



1 x F9

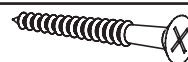

12 x

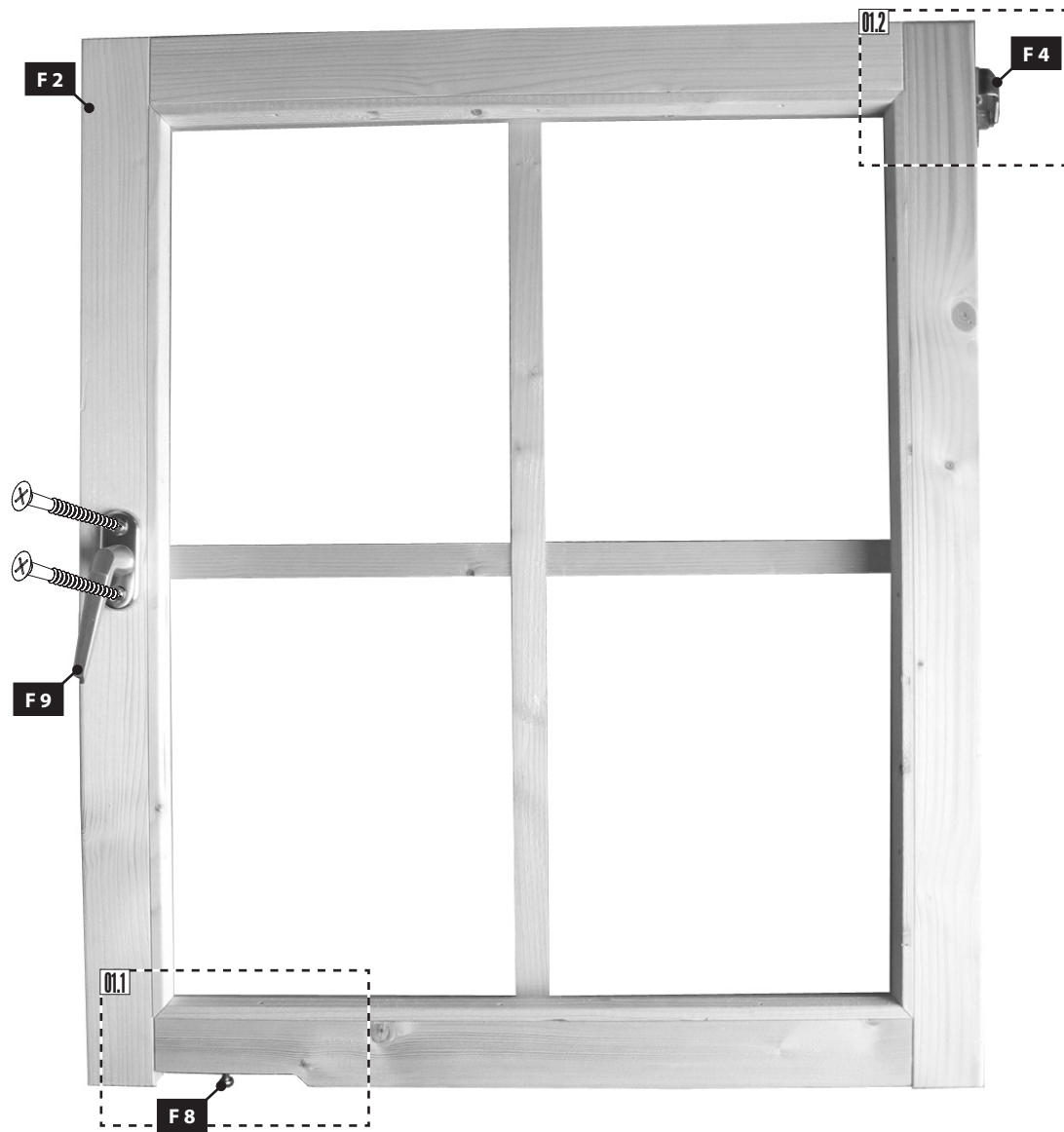

01.1

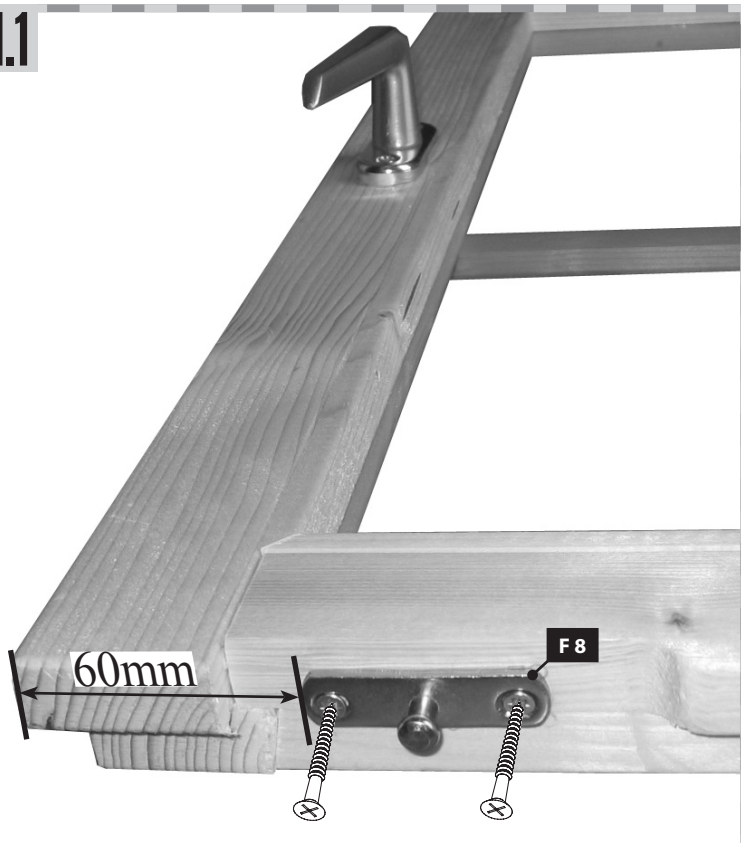

01.2

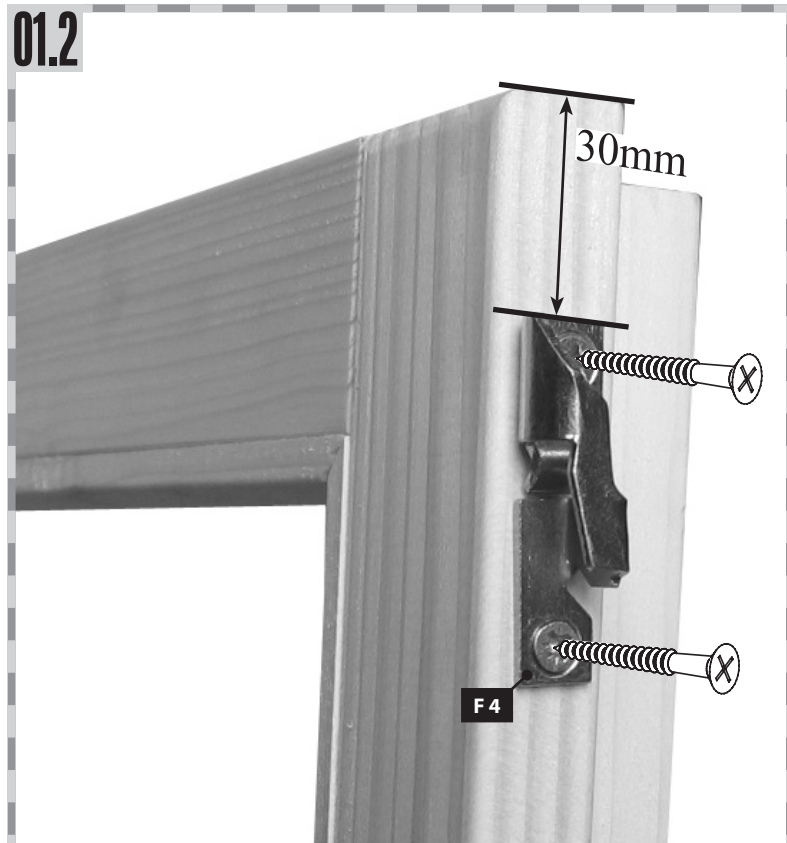

02

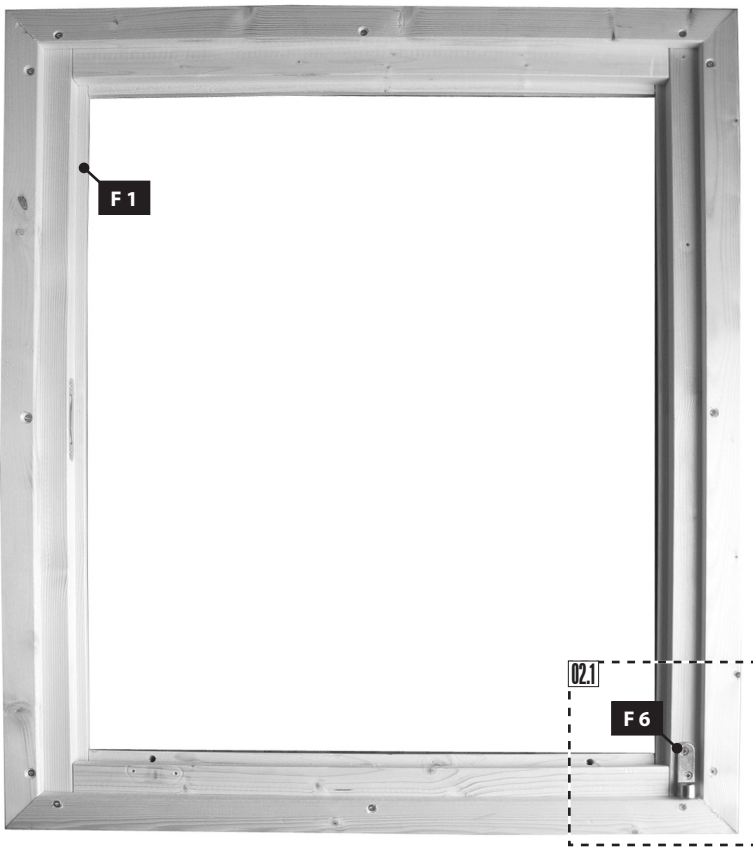

02.1

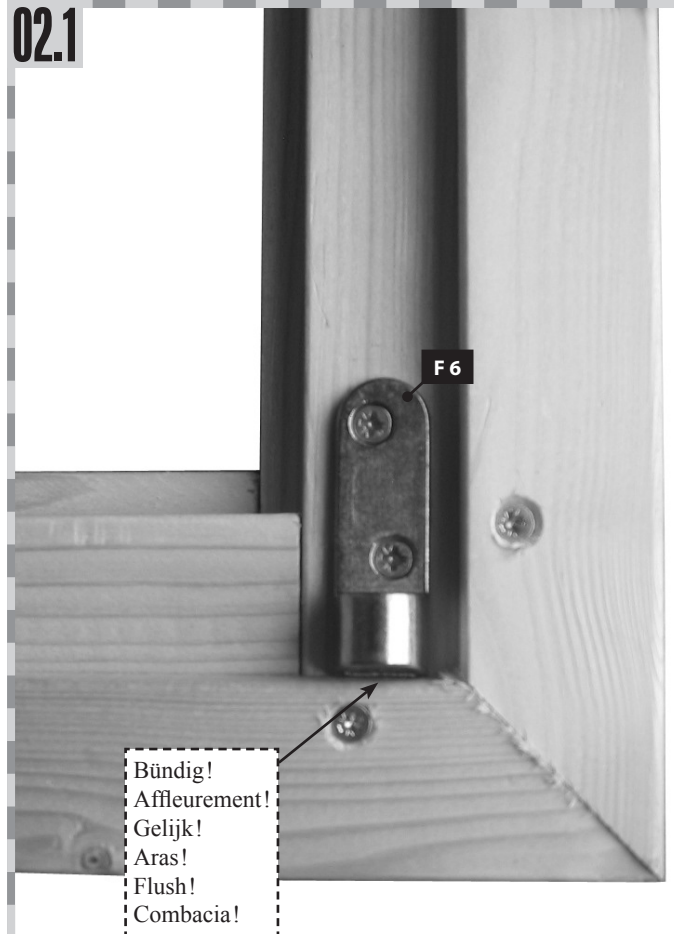

03

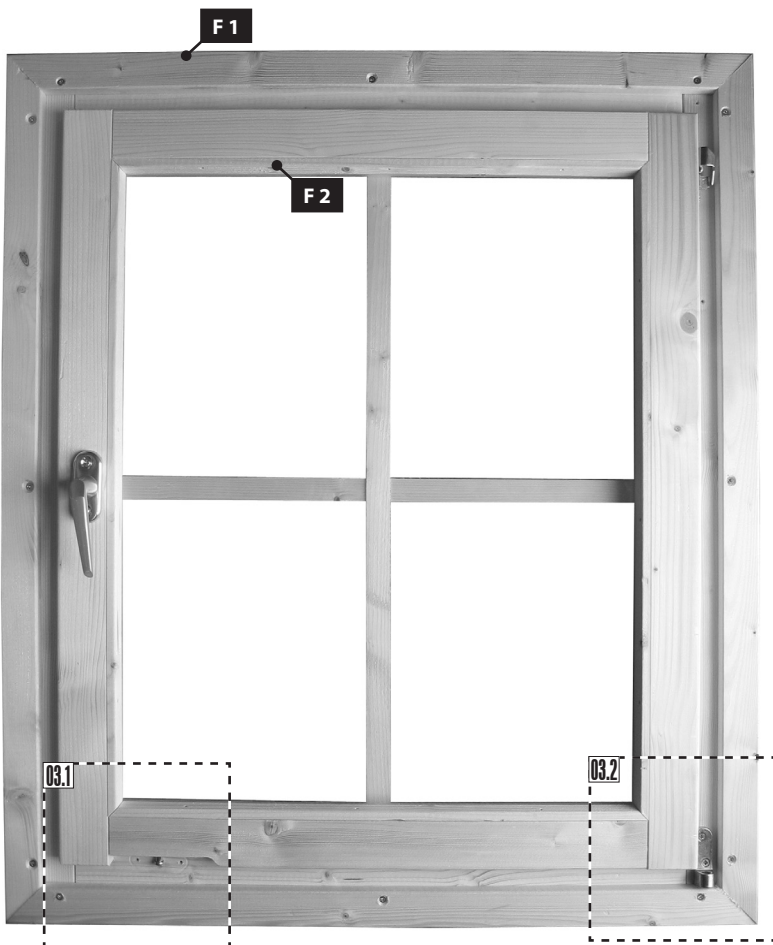

03.1

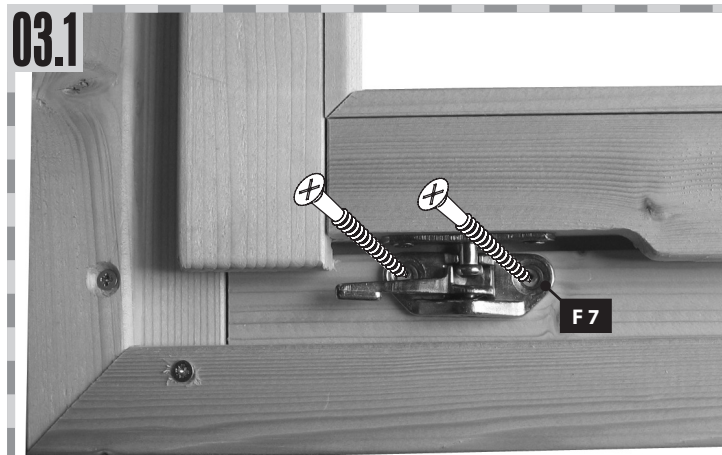

03.2



04



04.1

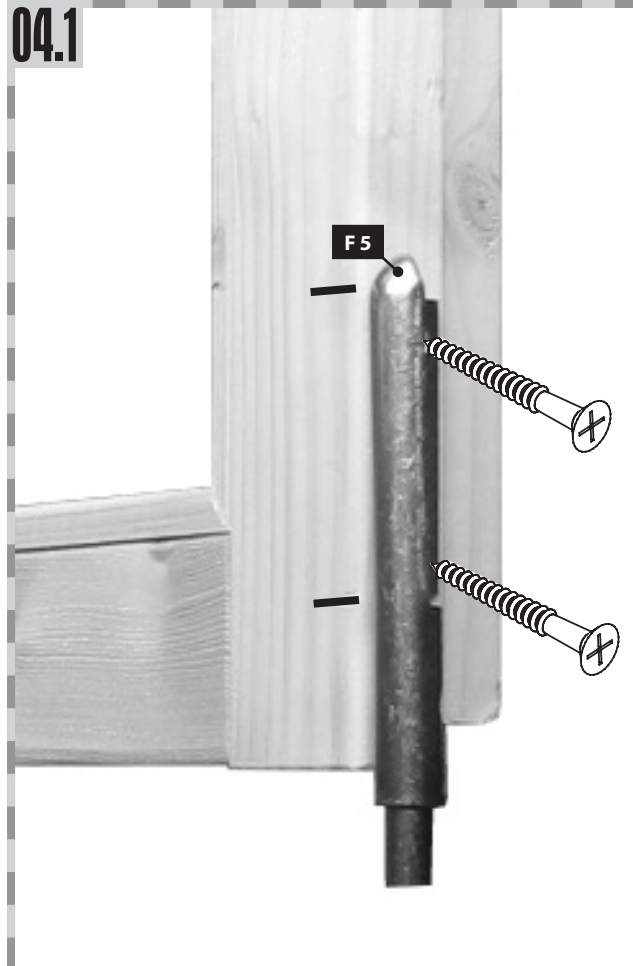

05

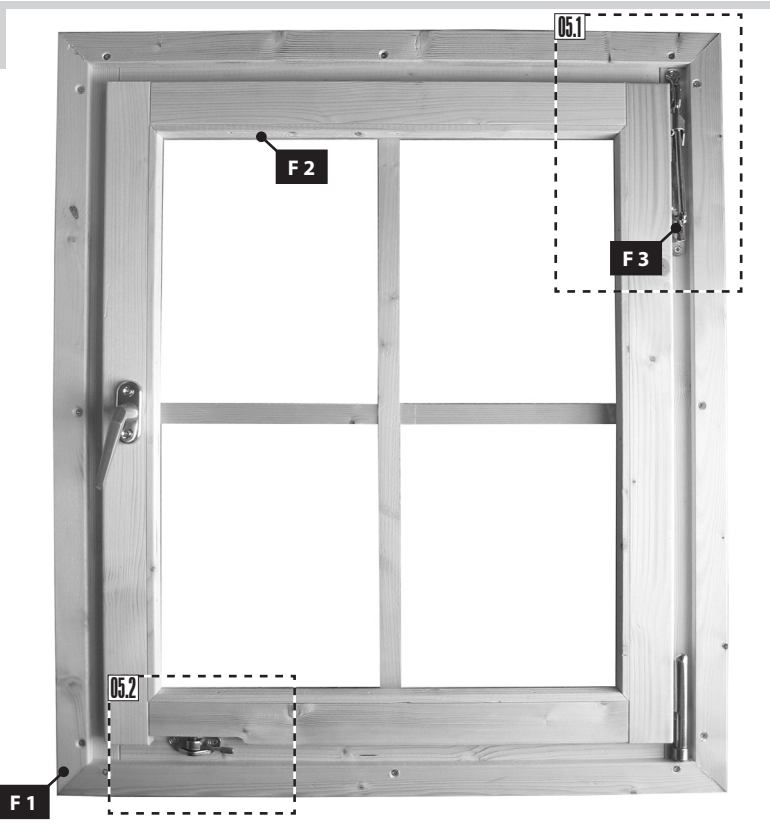



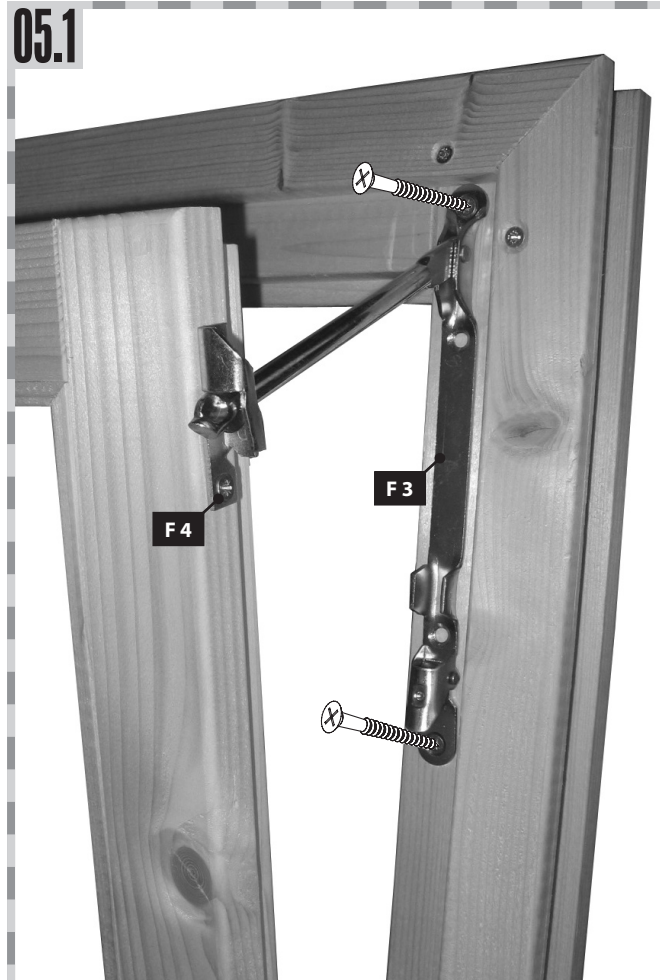



05.1



05.2

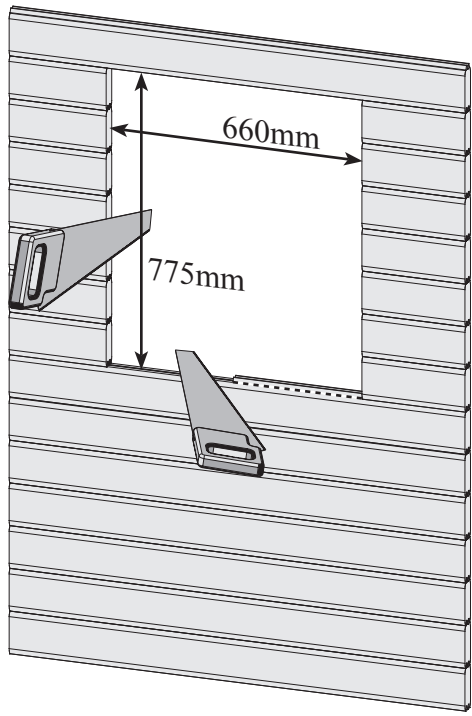
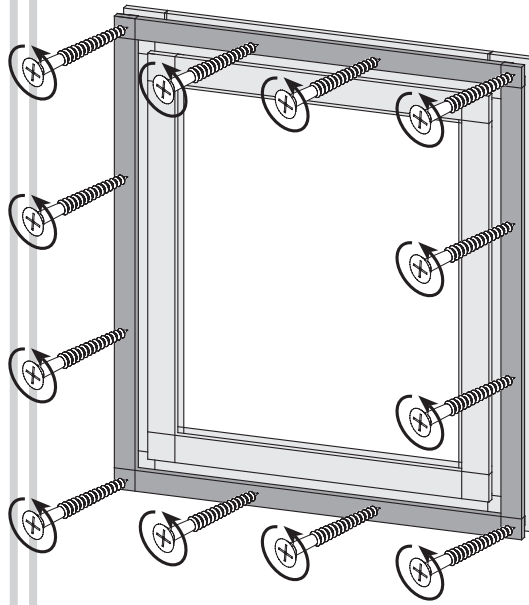
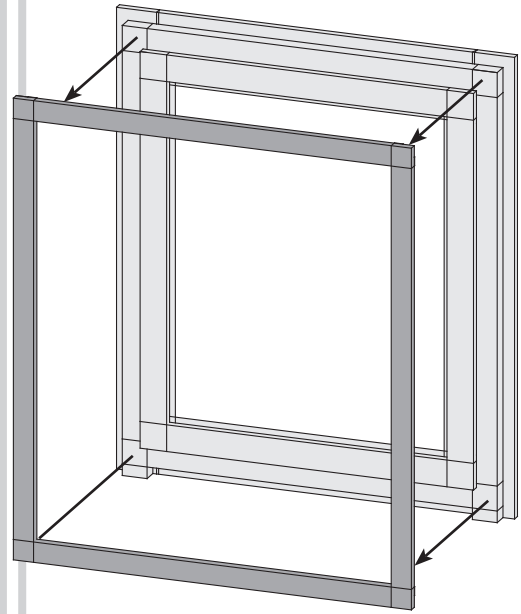
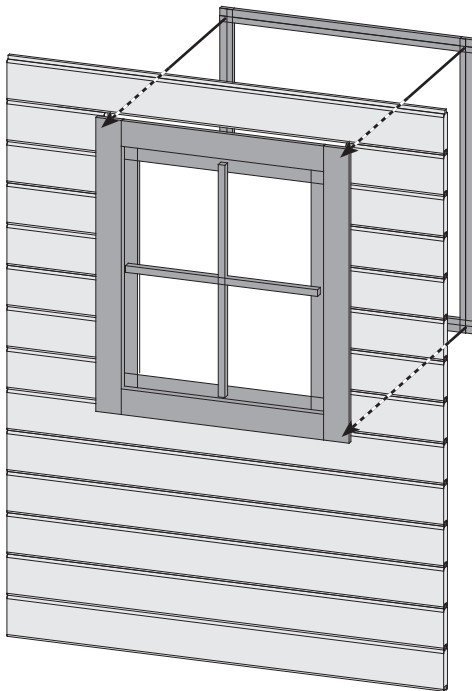

-  Führen Sie F3 durch F4 hindurch + Festschrauben
-  Mettez le F3 per F4 + Visser
-  Put F3 through F4 + Screw on
-  Gezette F3 door F4 + Schroef
-  Pase el F3 con F4 + Tornillo encendido
-  Faccia passare il F3 con F4 + Vite sopra

**01****02****03****04****05**