

61587

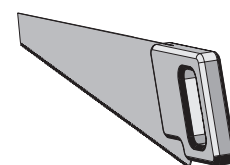
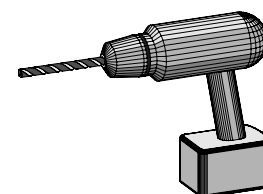
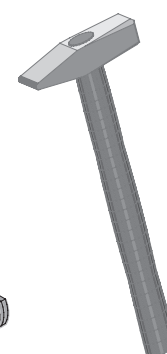
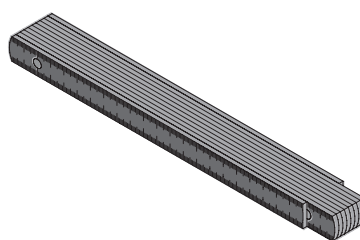
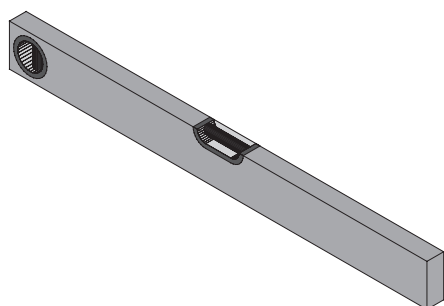
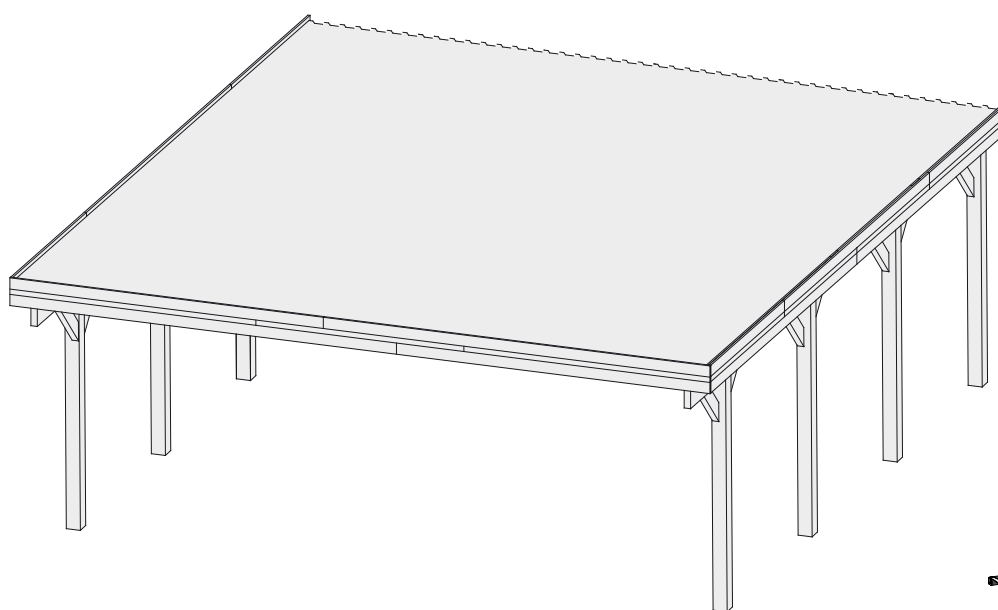

 **Aufbauanleitung**

 **notice de montage**

 **Building Instructions**

 **montagehandleiding**

 **Instrucciones de construcción**

 **Istruzioni per il montaggio**

 **Service-Hotline: +49 421 38693 33**

 Vergleichen Sie zuerst diese Materialliste mit Ihrem Paketinhalt! Bitte haben Sie Verständnis, daß Beanstandungen nur im nicht aufgebauten Zustand bearbeitet werden können!

 Vergelijk eerst deze materiaallijst met de inhoud van uw pakket. Wij vragen uw begrip voor het feit dat we klachten enkel in niet opgebouwde toestand kunnen behandelen.

 Veuillez d'abord comparer la liste du matériel avec le contenu de votre paquet ! Nous vous remercions de bien vouloir comprendre que nous traitons uniquement les réclamations concernant le matériel à l'état non monté !

 ¡En primer lugar compare la lista de material con el contenido de su paquete! ¡Rogamos entienda que las reclamaciones solo pueden ser tramitadas antes de montar el objeto!

 First, check and compare the list of materials with the contents of your package! We ask for your understanding that complaints can only be processed when the product has not been assembled!

 Confrontate questa distinta materiali con il contenuto del pacchetto! Vi preghiamo di comprendere che eventuali reclami possono essere accolti solo prima del montaggio!

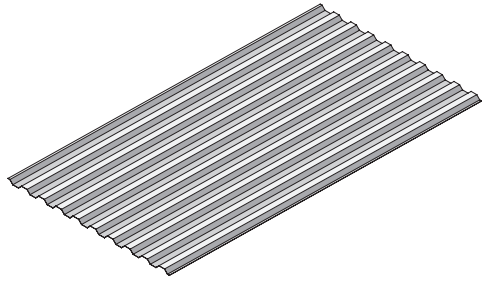

6 x D1	2000 x 1090 mm	ID 61408
--------	----------------	----------

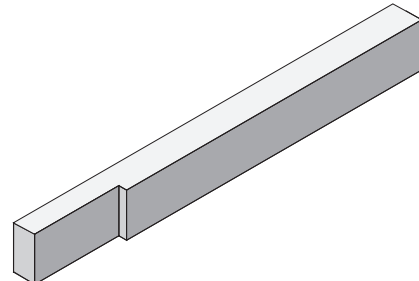

2 x U3	2100 x 120 x 120 mm	ID 40629
--------	---------------------	----------

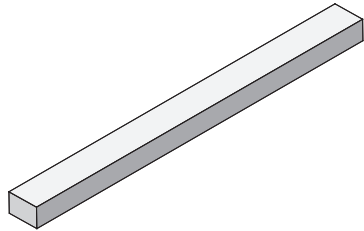

4 x B1	2100 x 45 x 18 mm	ID 17405
2 x B3	2100 x 95 x 18 mm	ID 52311
2 x B4	3300 x 95 x 18 mm	ID 51821
1 x B5	5905 x 60 x 40 mm	ID 40807
2 x B6	5940 x 190 x 70 mm	ID 62663

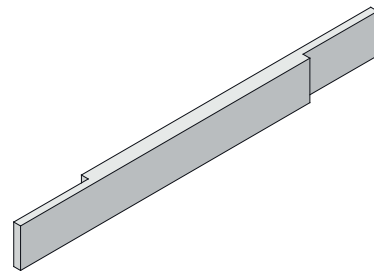

2 x U4	2190 x 155 x 55 mm	ID 40627
--------	--------------------	----------

1 x



ID 40772

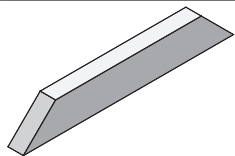

4 x U5	750 x 115 x 55 mm	ID 16478
--------	-------------------	----------

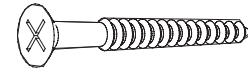

110 x	4 x 50 mm	ID 3688
25 x	4,5 x 80 mm	ID 9204
10 x	6 x 160 mm	ID 9252

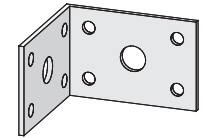

4 x S3	50 x 50 x 35 mm	ID 21292
--------	-----------------	----------

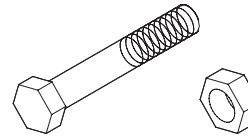

2 x	M12 x 140 mm	ID 40787
-----	--------------	----------



4 x S1	12,5 x 44 mm	ID 12011
--------	--------------	----------

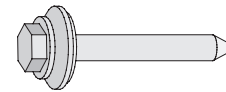

200 x	4,0 x 38 mm	ID 36178
-------	-------------	----------



2 x S2	45 mm	ID 9253
--------	-------	---------