

# 41961

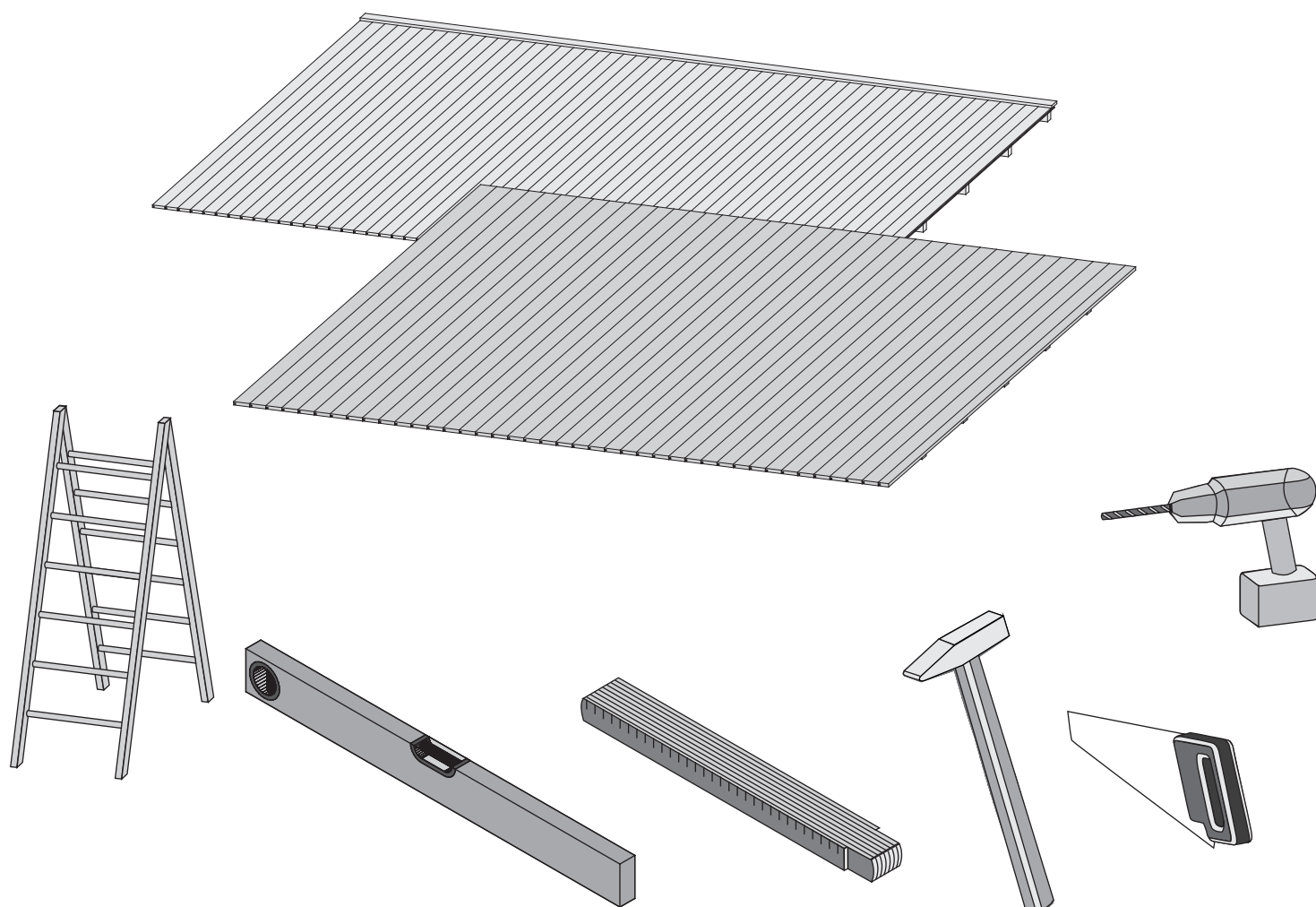

 **Aufbauanleitung**

 **notice de montage**

 **Building Instructions**

 **montagehandleiding**

 **Instrucciones de construcción**

 **Istruzioni per il montaggio**

 **Montážní návod**

 **Service-Hotline: +49 421 38693 33**



Vergleichen Sie zuerst die Materialliste mit Ihrem Paketinhalt! Bitte haben Sie Verständnis, dass Beanstandungen nur im nicht aufgebauten Zustand bearbeitet werden können!



Commencez par comparer la liste du matériel avec le contenu de votre paquet! Sachez que nous traitons uniquement les réclamations concernant le matériel à l'état non monté!



First compare the list of materials with your package contents! Please understand that complaints can be processed in the non-built status only!



Vergelijk eerst de lijst van materialen met de inhoud van uw pakket! Reclamaties kunnen alleen in behandeling worden genomen zolang de onderdelen nog niet zijn gemonteerd!



En primer lugar, compare la lista de material con el contenido del paquete. Rogamos entienda que las reclamaciones sólo pueden ser tramitadas antes de montar el objeto!



Confrontate questa distinta materiali prima con il contenuto del pacchetto! Vi preghiamo di comprendere che eventuali reclami possono essere accolti solo prima del montaggio!

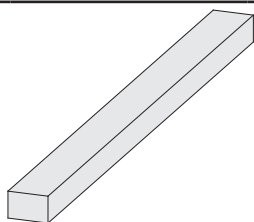
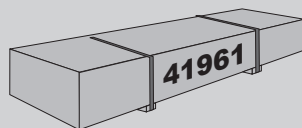

1 x A10	3645 x 95 x 18mm	ID 42425
5 x A11	3690 x 60 x 40mm	ID 28688

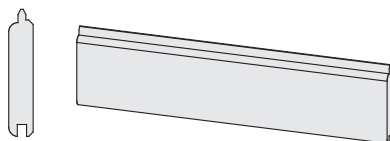



42 x B10	3600 x 96 x 19mm	ID 19572
----------	------------------	----------

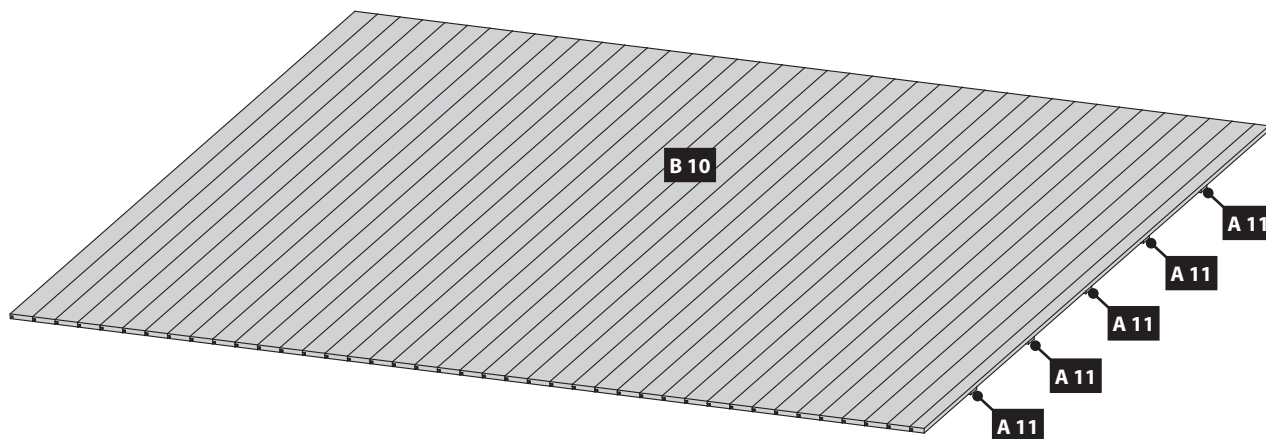
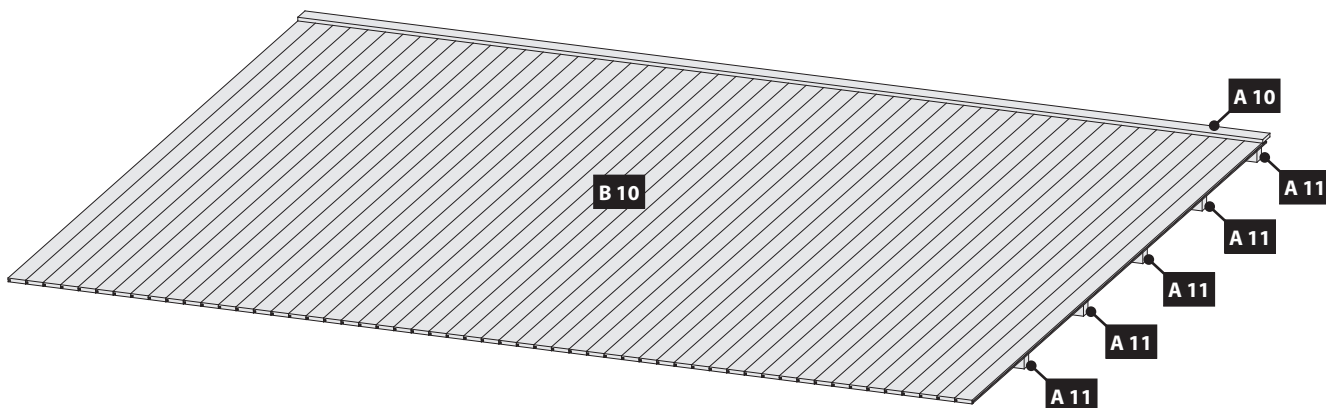

550x		ID 25453
------	--	----------



 Lieber Kunde, achten Sie auf die richtige Aufbau-Variante!

 Geachte klant, let dan op de juiste montage-versie!

 Dear customer, pay attention to the correct design variant!

 Cher client, attention à la version de montage correct!

 Estimado cliente, prestar atención a la versión montaje correcto!





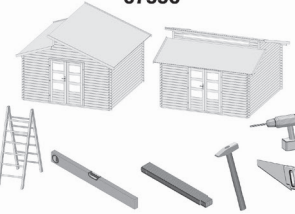

 Caro cliente, prestare attenzione alla versione corretto montaggio!

 Vážení zákazník, dbát na správnou montážní verzi!



67556 05.09.2014





 Aufbauanleitung  
 notice de montage  
 Building Instructions  
 montagehandleiding  
 Instrucciones de construcción  
 Istruzioni per il montaggio

 Service-Hotline: +49 421 38693 33

67524 08.12.2014









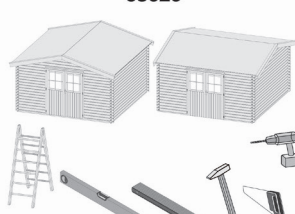

 Aufbauanleitung  
 notice de montage  
 Building Instructions  
 montagehandleiding  
 Instrucciones de construcción  
 Istruzioni per il montaggio

 Service-Hotline: +49 421 38693 33

68029 12.01.2016





 Aufbauanleitung  
 notice de montage  
 Building Instructions  
 montagehandleiding  
 Instrucciones de construcción  
 Istruzioni per il montaggio  
 Montážní návod

 Service-Hotline: +49 421 38693 33

77487 09.02.2017









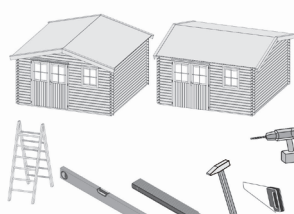

 Aufbauanleitung  
 notice de montage  
 Building Instructions  
 montagehandleiding  
 Instrucciones de construcción  
 Istruzioni per il montaggio  
 Montážní návod

 Service-Hotline: +49 421 38693 33

64295 21.01.2016





 Aufbauanleitung  
 notice de montage  
 Building Instructions  
 montagehandleiding  
 Instrucciones de construcción  
 Istruzioni per il montaggio  
 Montážní návod

 Service-Hotline: +49 421 38693 33



81869 25.09.2017





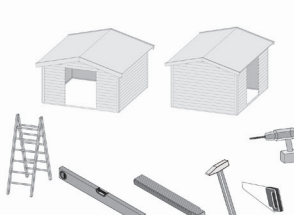

 Aufbauanleitung  
 notice de montage  
 Building Instructions  
 montagehandleiding  
 Instrucciones de construcción  
 Istruzioni per il montaggio  
 Montážní návod

 Service-Hotline: +49 421 38693 33

81876 25.09.2017









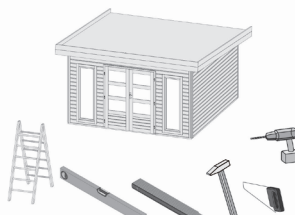

 Aufbauanleitung  
 notice de montage  
 Building Instructions  
 montagehandleiding  
 Instrucciones de construcción  
 Istruzioni per il montaggio  
 Montážní návod

 Service-Hotline: +49 421 38693 33

67425 67427 67837 67838 22.01.2017









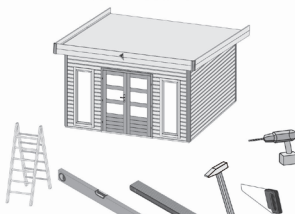

 Aufbauanleitung  
 notice de montage  
 Building Instructions  
 montagehandleiding  
 Instrucciones de construcción  
 Istruzioni per il montaggio  
 Montážní návod

 Service-Hotline: +49 421 38693 33

67425 67427 23.01.2017











 Aufbauanleitung  
 notice de montage  
 Building Instructions  
 montagehandleiding  
 Instrucciones de construcción  
 Istruzioni per il montaggio  
 Montážní návod

 Service-Hotline: +49 421 38693 33

67421 67423 67839 67840 26.02.2017



 Aufbauanleitung  
 notice de montage  
 Building Instructions  
 montagehandleiding  
 Instrucciones de construcción  
 Istruzioni per il montaggio  
 Montážní návod

 Service-Hotline: +49 421 38693 33

82884 82885 12.09.2017



 Aufbauanleitung  
 notice de montage  
 Building Instructions  
 montagehandleiding  
 Instrucciones de construcción  
 Istruzioni per il montaggio  
 Montážní návod

 Service-Hotline: +49 421 38693 33

# A

01

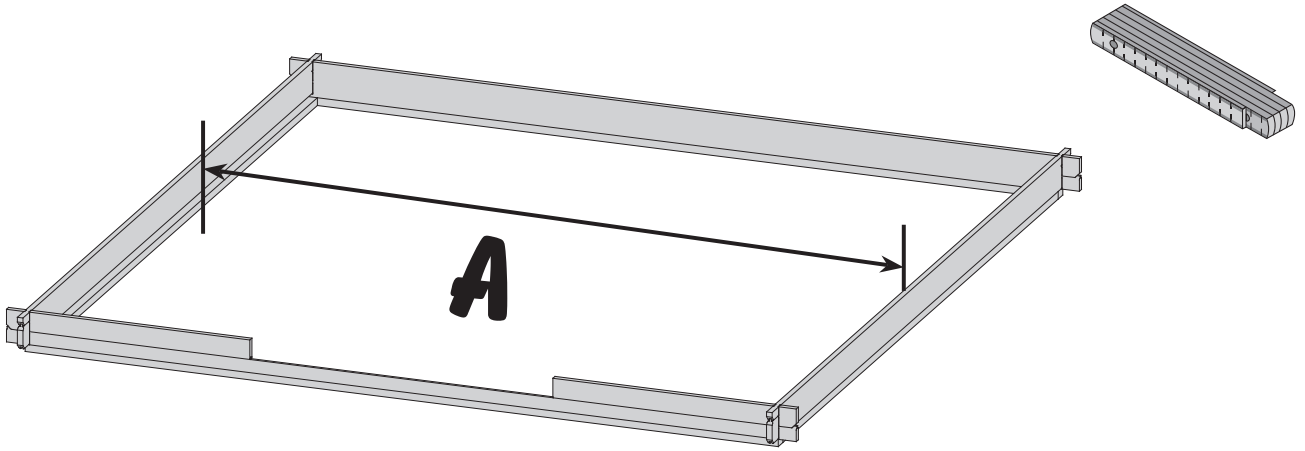

02 5x

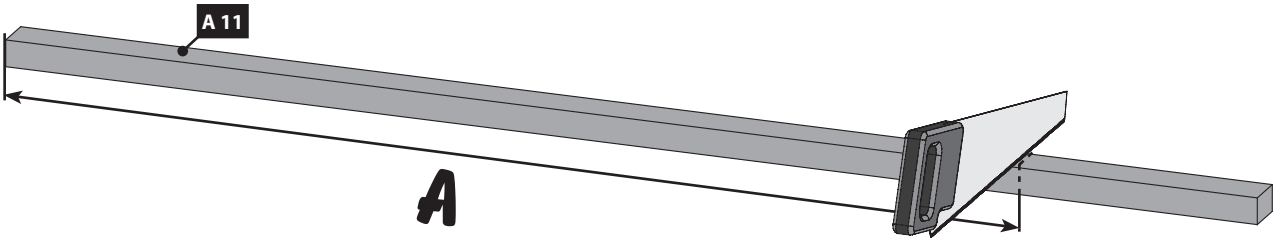

03

**!!! A=B=C=D=E !!!**

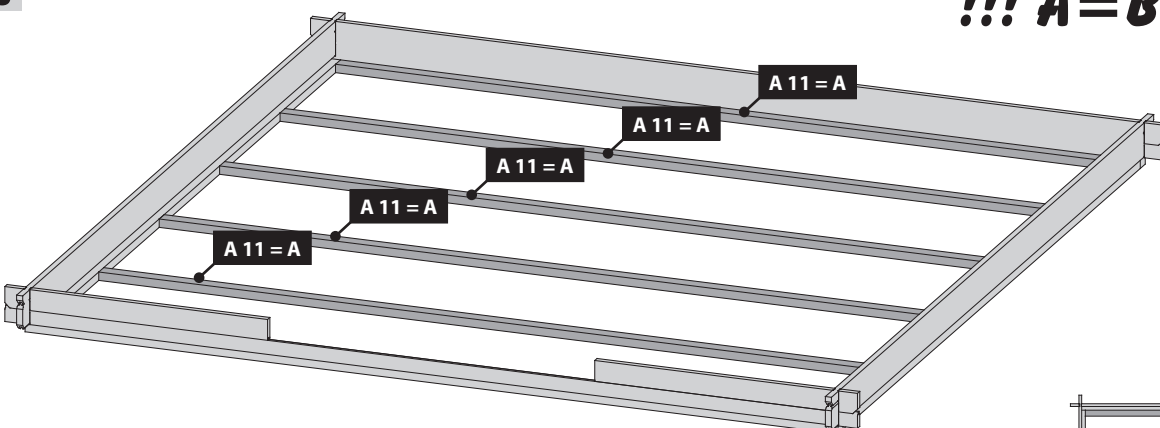

-  Draufsicht
-  bovenaanzicht
-  Top view
-  vue de dessus
-  vista desde arriba
-  vista dall'alto
-  púdorys

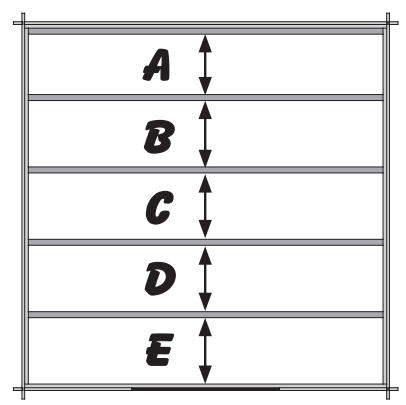

# A

04

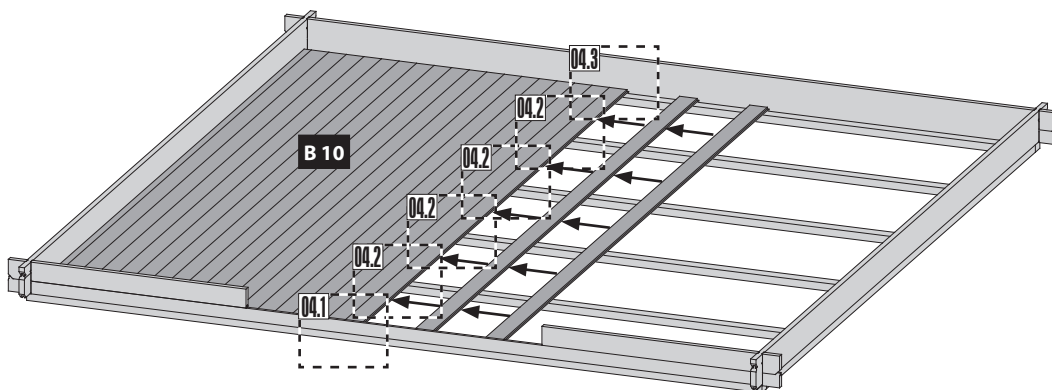

04.1

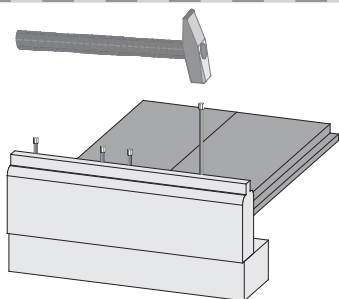

04.2

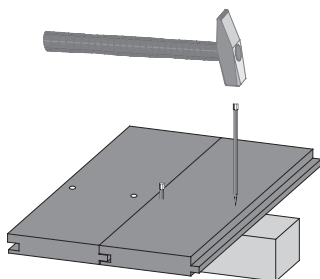

04.3

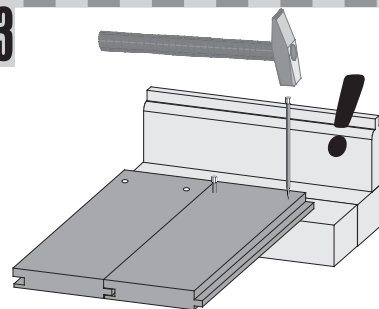

05

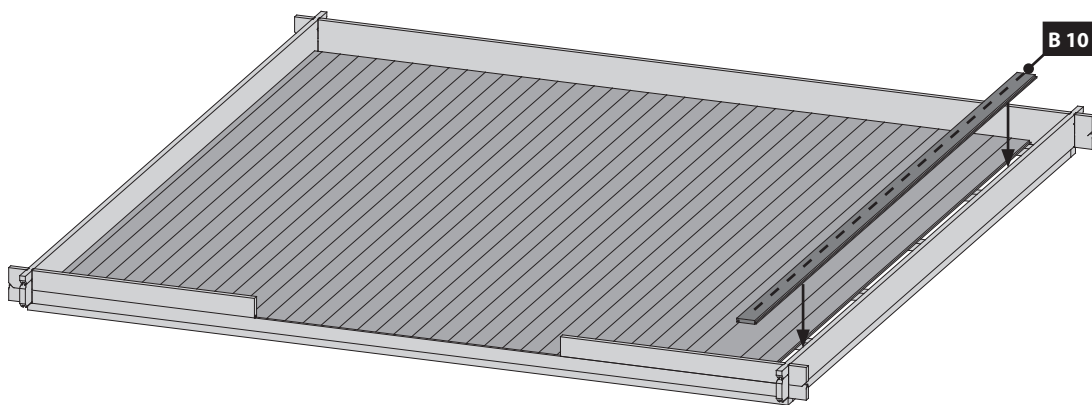

Bündig!  
Affleurement!  
Gelijk!  
Aras!  
Flush!  
Combacia!  
Stejný!

06

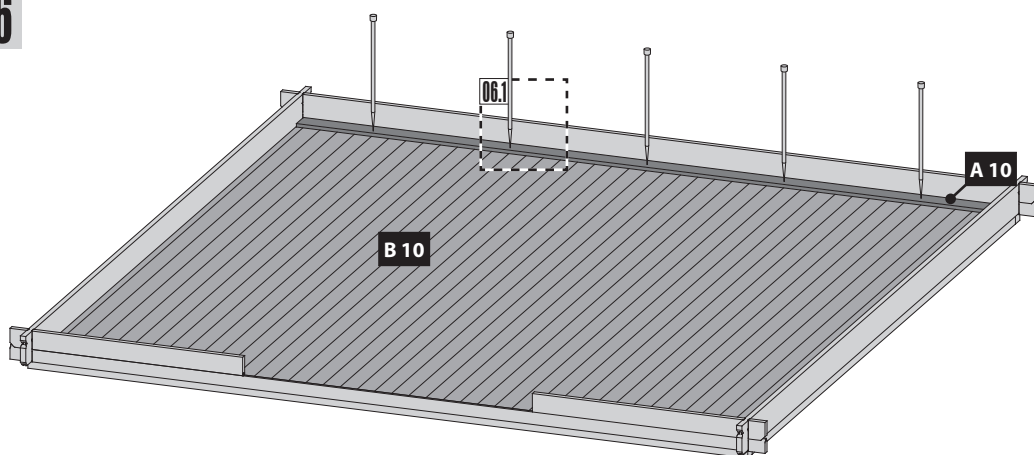

06.1

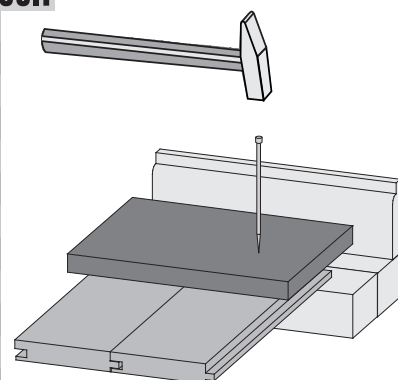

# B

01

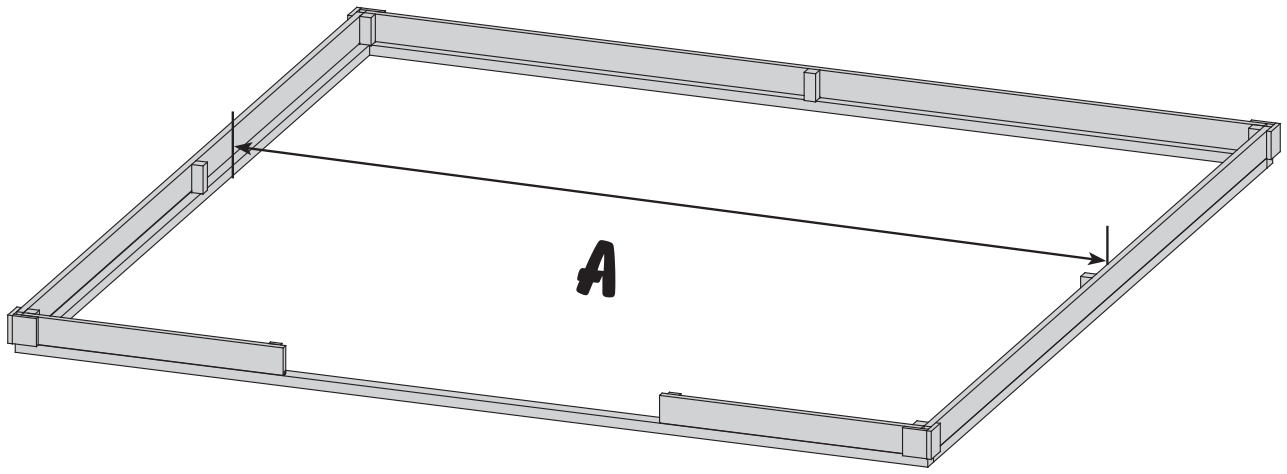

02

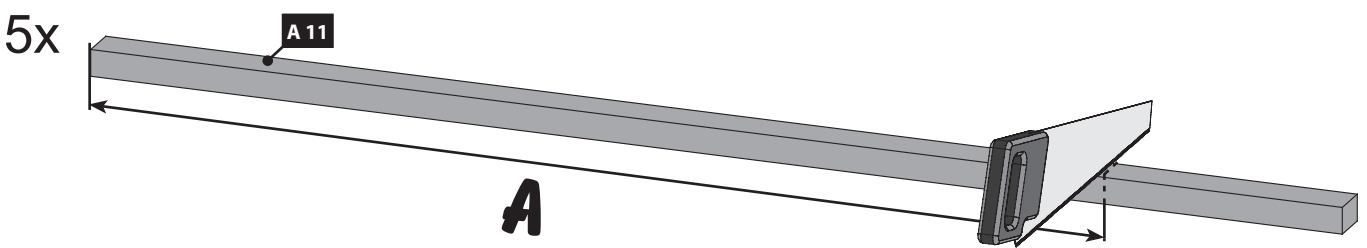

03

**!!! A=B=C=D=E=F !!!**

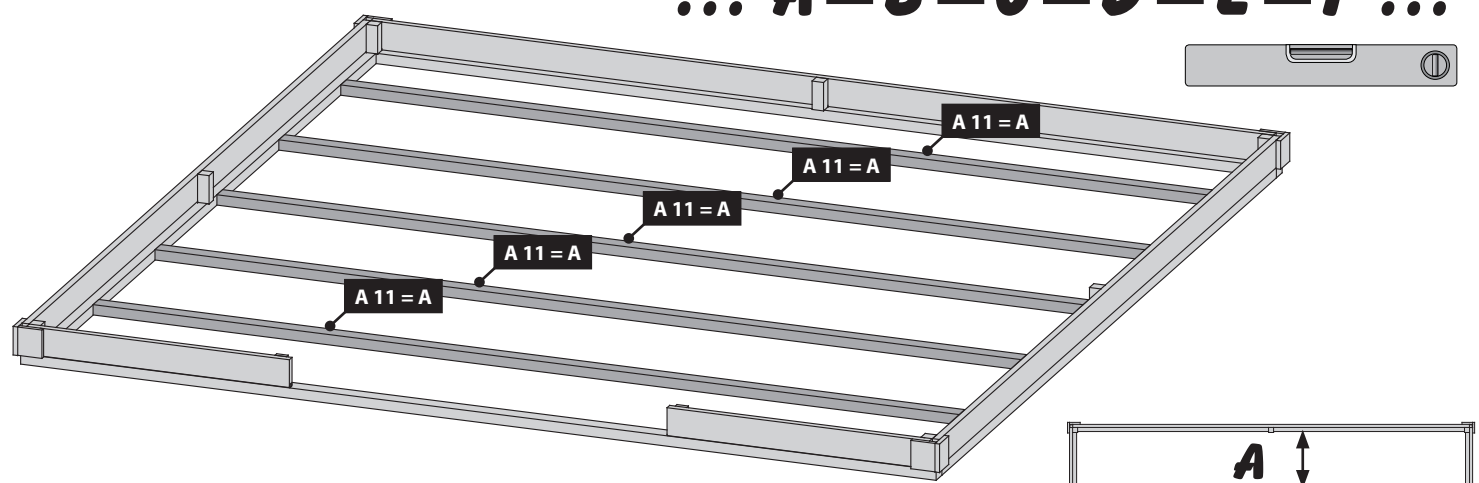

-  Draufsicht
-  bovenaanzicht
-  Top view
-  vue de dessus
-  vista desde arriba
-  vista dall'alto
-  pŕůdorys

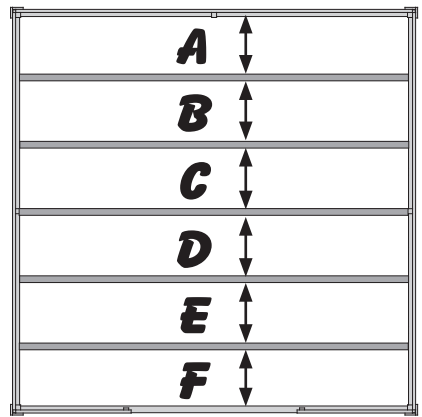

# B

04

Bündig!  
Affleurement!  
Gelijk!  
Aras!  
Flush!  
Combacia!  
Stejný!

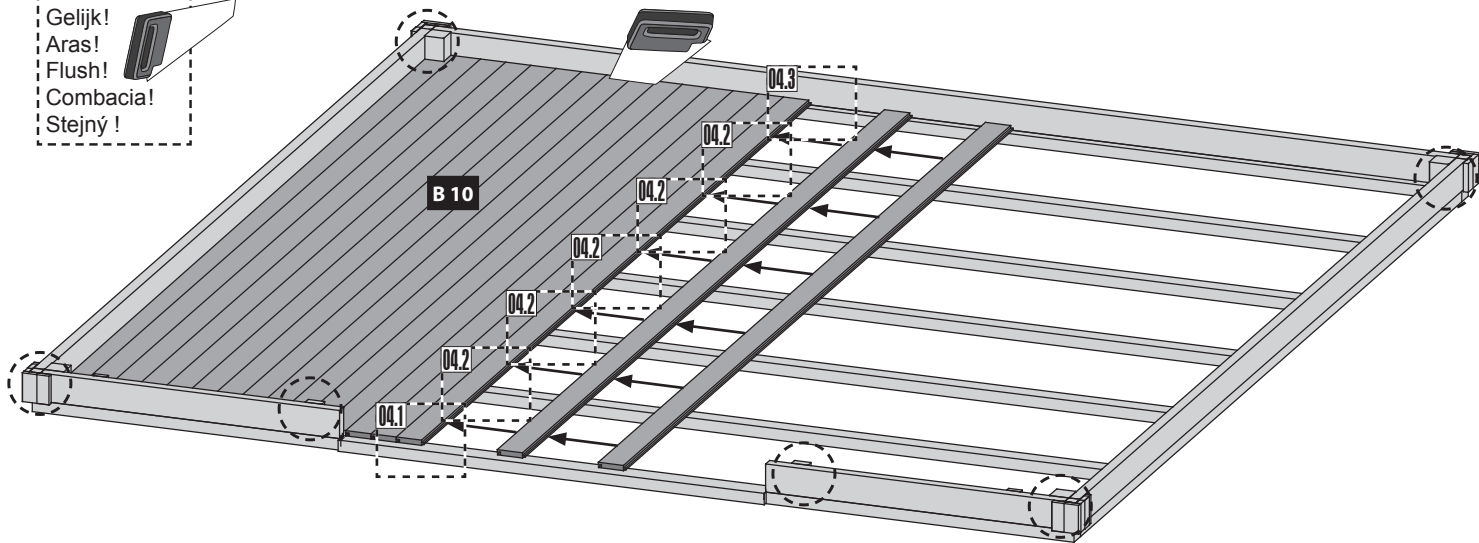
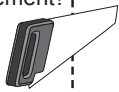

04.1

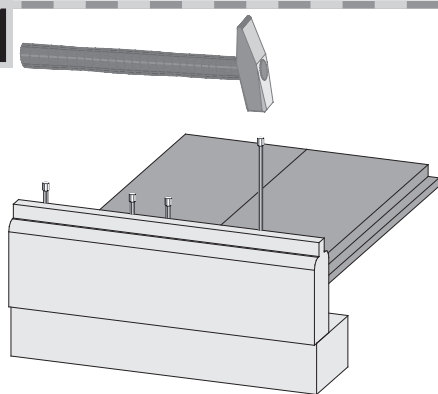

04.2

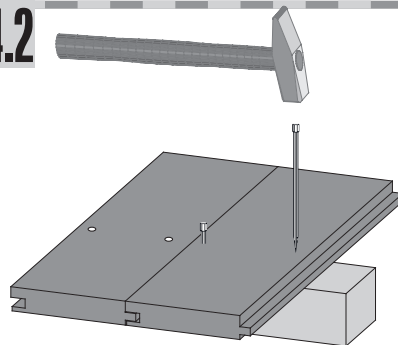

04.3

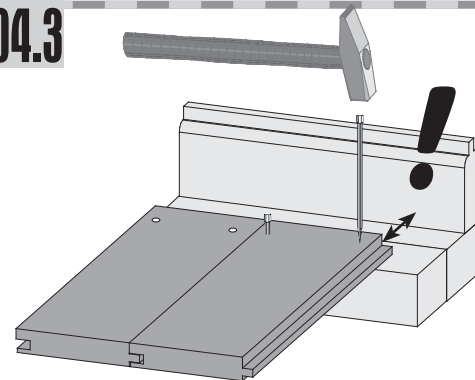

05

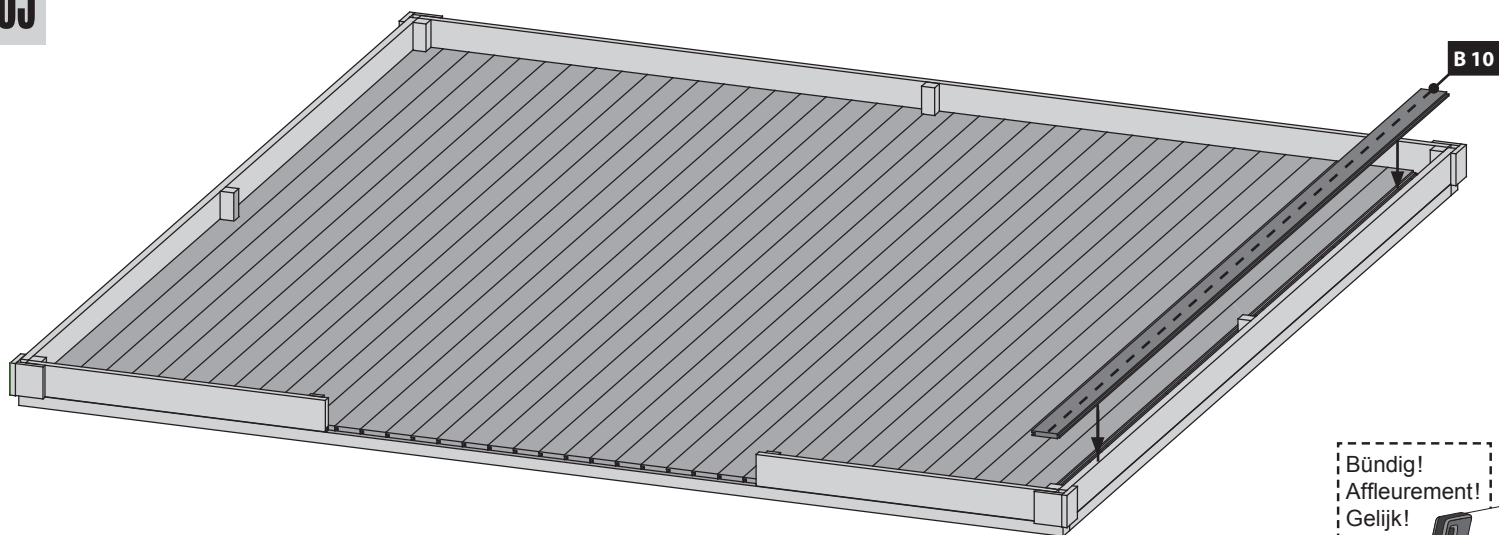

Bündig!  
Affleurement!  
Gelijk!  
Aras!  
Flush!  
Combacia!  
Stejný!

