

Technische Daten

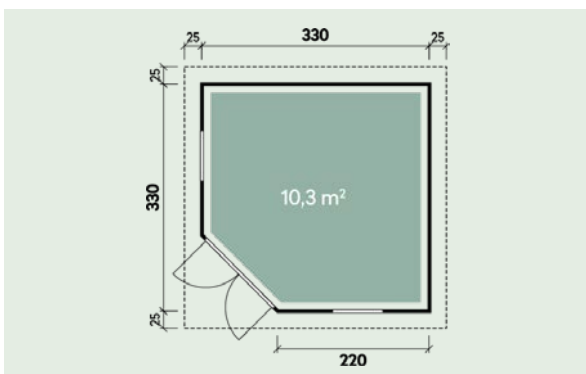

Artikelnummer:

840 170



Kontrolliert durch:

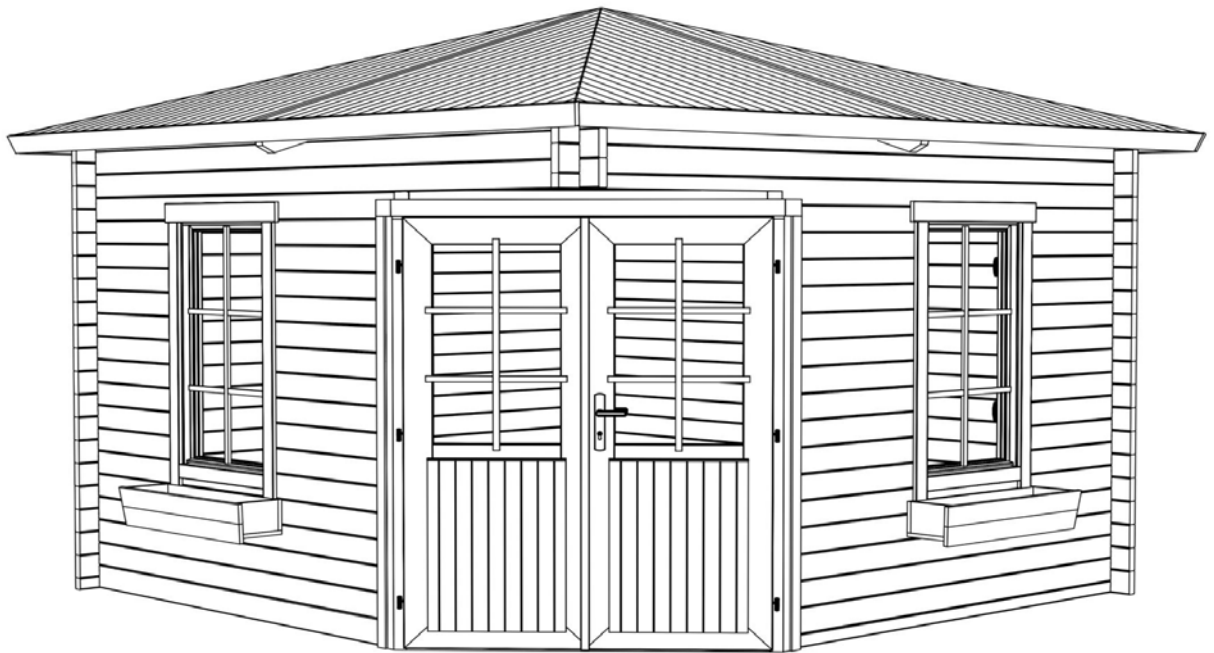



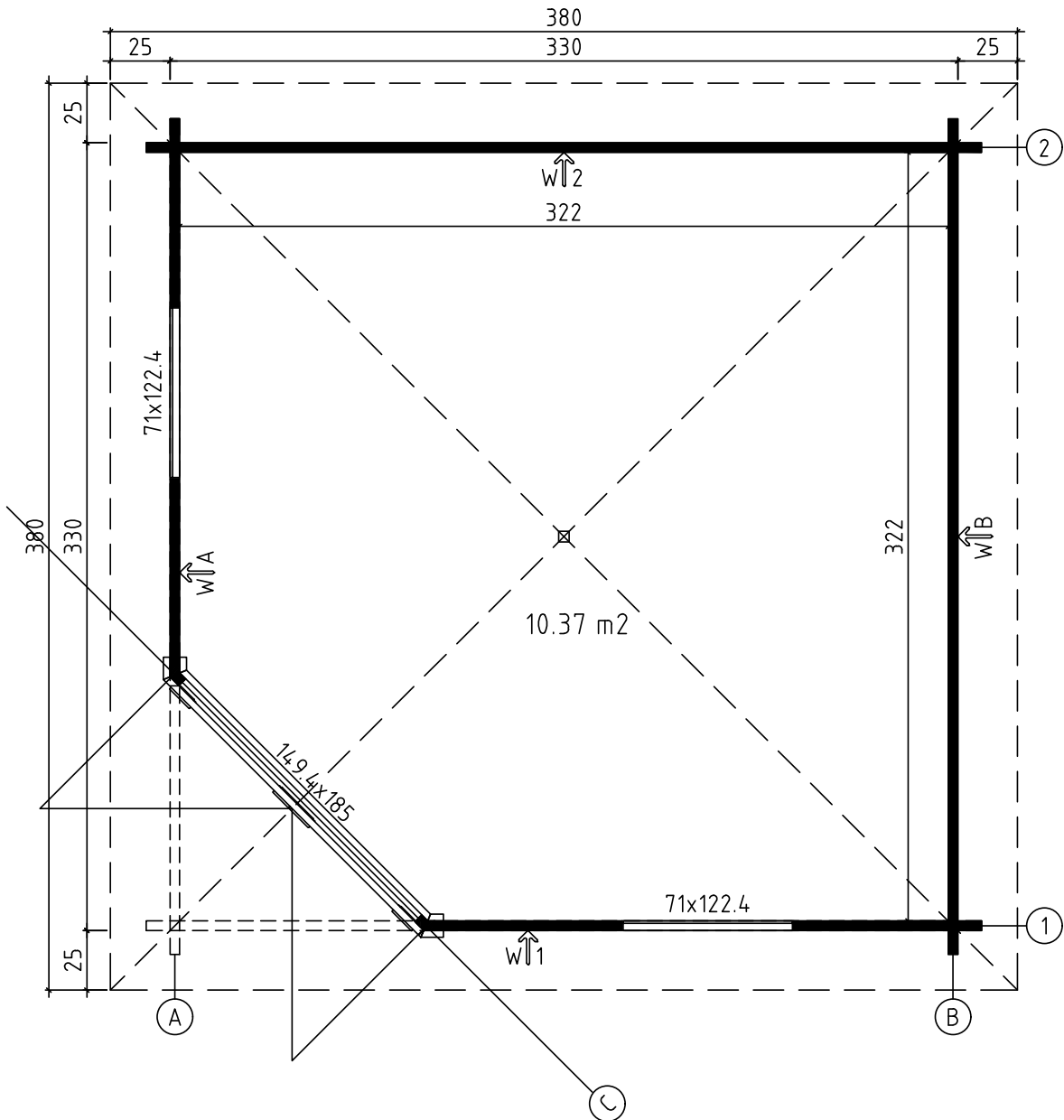

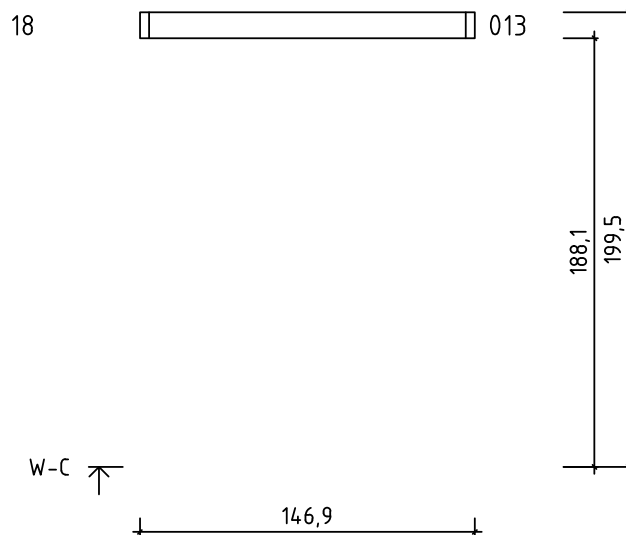
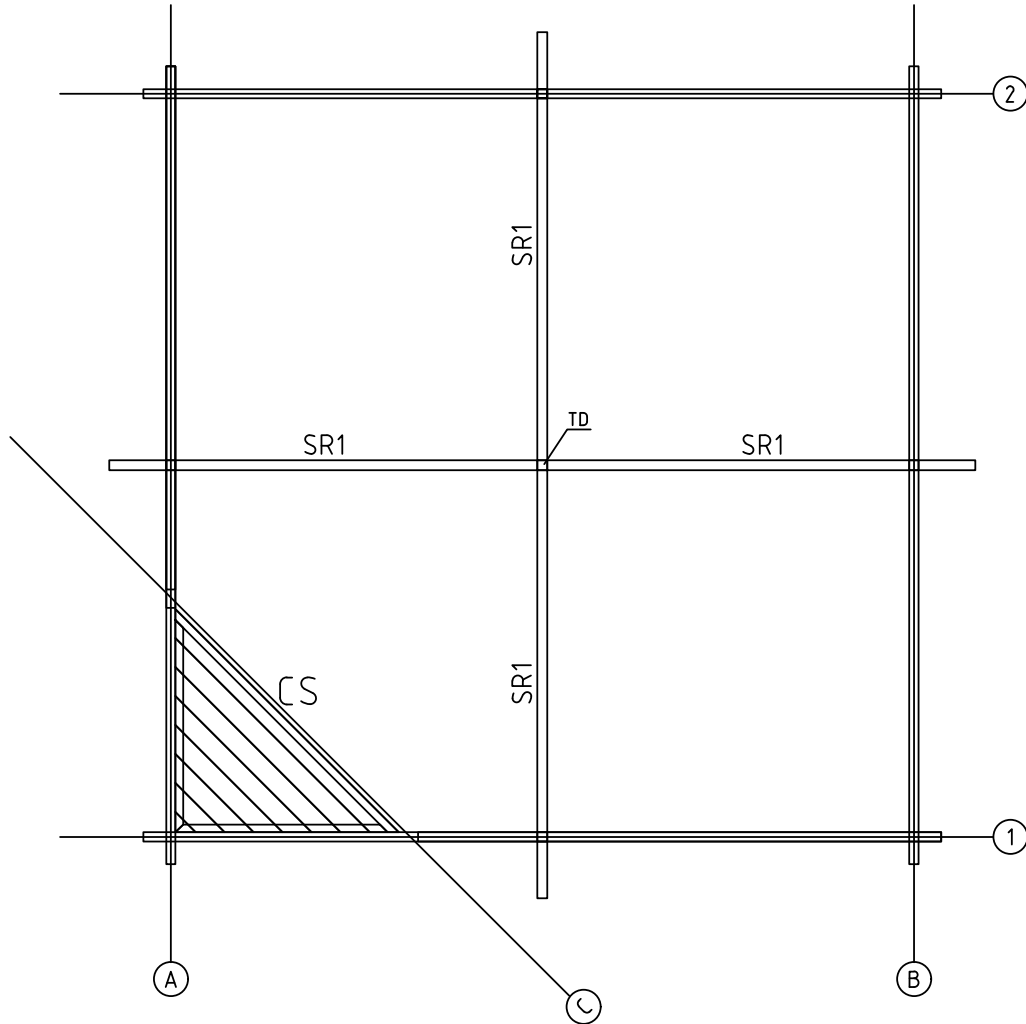

Grundplan - Grundplan - Plan de masse - Planimetria -
Plattegrond - Põhiplaan



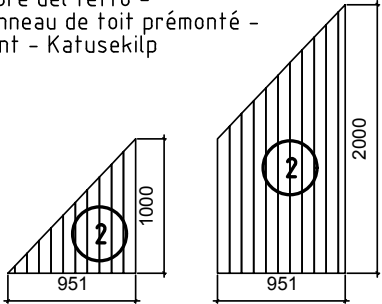
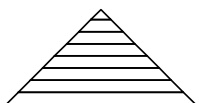

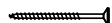
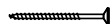
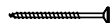
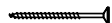
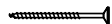

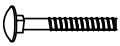
Overhead beams - Deckenbalken - Solives - Travi a vista -
Overlopende balken - Laetalade konstruktsioon



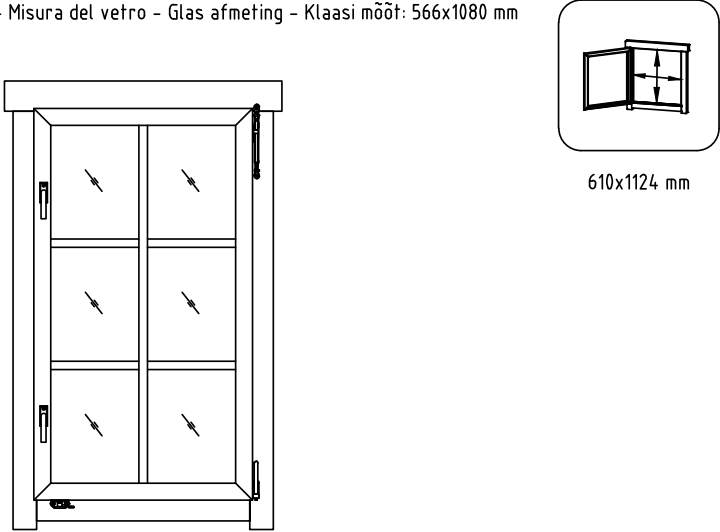

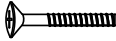
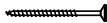

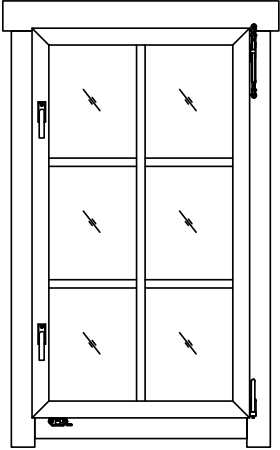
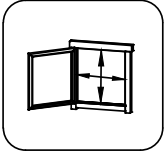

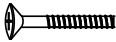
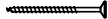

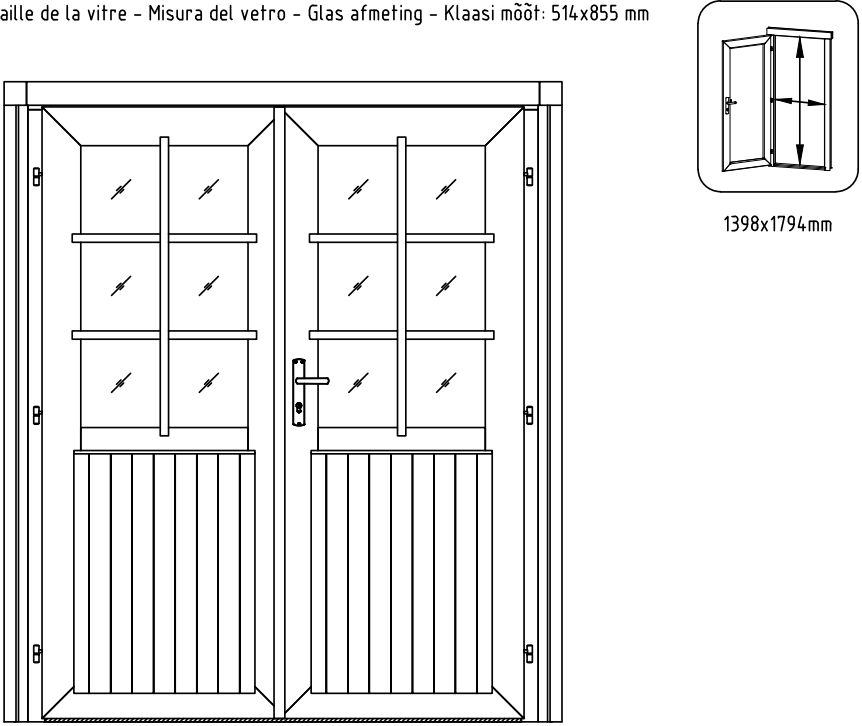





Pos	Piece list - Stückliste - Liste des pièces - Elementi - Stuklijst - Tükítabel 29.09.2023 6/7	Q	P (mm)	L (mm)
001		1	40x57	2295
002		10	40x114	2295
003		21	40x114	788
004		21	40x114	788
005		1	40x114	3500
006 30246		42	40x114	3500
007		2	40x57	1728
008		2	40x57	1728
009 30251		1	40x57	3500
010		1	40x114	2295
011		1	40x114	2375
013		1	40x114	1469
WA-1		1		
WB-1		1		
SR1	SARIKAD 	4	44x140	1975
TB5-1 759	Fascia board - Traufbrett - Bandeau de toit - Finitura lati tetto - Gevellijst - Räästalaud	4	18x90	4000
KFS-1 27180	Storm protection - Sturmleiste - Latte anti-tempete - Protezione anti vento - Stormverankering / beveiliging - Tormikinnitusliist	5	22x45	2500
EL	Roof shield detail - Element - Panneau de toiture - Elementi della - copertura superiore del tetto - Roof element - Dachelement - Panneau de toit prémonté - Componente del tetto - Dakelement - Katusekilp 	4 4	62x951 62x951	2000 1000

Pos	29.09.2023 Piece list - Stückliste - Liste des pièces - Elementi - Stuklijst - Tükitalabel 7/7	Q	P (mm)	L (mm)
EL	Roof shield detail - Element - Panneau de toiture - Elementi della - copertura superiore del tetto - Roof element - Dachelement - Panneau de toit pré-monté - Componente del tetto - Dakelement - Katusekilp 	4 4	62x951 62x951	2000 1000
CS	Roof element - Dachelement - Panneau de toit pré-monté - Componente del tetto - Dakelement - Katusekilp 	1	1386x693	
TD 17771	Roof support - Dach träger - Support de toit - Supporto del tetto - Dak ondersteuning - Katusetugi	1	44x44	153
HS14	Screw for wall details - Schraube für wand details - Vis pour mur details - Viti per elementi della porta - Schroef voor wand details - Kruvi seinte montaažiks 	4	4.5x80	
HS12 5109	Screw for fascia boards - Schrauben für traufbretter - Vis pour fixation bandeau de toit - Viti x striscia del tetto - Schroef voor gevellijst - Kruvi räästalauale 	36	4x40	
HS13	Screw for triangular fixing - Montagschraube für dreieckige - Vis d'assemblage pour triangle - Vite per fissaggio triangolare - Schroef voor driehoekig afdekljst - Kruvi kolmnurga monteerimiseks seinale 	10	4x60	
HS18 5113	Screw for fixing roof elements - Schraube für befestigung dachelementen - Vis de fixation des panneaux de toit - Vite per fissare gli elementi del tetto - Schroef voor bevestiging dakelement - Kruvi kilpide kinnitamiseks seinaga 	48	5x120	
HS18 5113	Screw for rafter - Schrauben für dachsparren - Vis pour chevron - Vite per trave - Schroef voor dakspar - Kruvi sarikatele 	12	5x120	
HS16 5115	Screw for wall details - Schraube für wand details - Vis pour mur details - Viti per elementi della porta - Schroef voor wand details - Kruvi seinadetailidele 	2	5x90	
HS21	Screw for fixing roof elements - Schraube für befestigung - dachelementen - Vis de fixation des panneaux de toit - Vite per fissare gli elementi del tetto - Schroef voor bevestiging dakelement - Kruvi kilpide montaažiks 	120	6x80	
32511	Hammer block - Schlagholz - Calle de frappe - Blocco di legno da usare come cuscinetto quando si usa il martello - Slagklos - Löögiklots 	1		
SF40 5133	Nut for storm protection - Schraubenmutter für sturmleiste - Ecrou pour latte anti-tempete - Dado x asta protezione vento - Moer voor stromverankering - Mutter tormikinnitusliistule 	10	D6	
BFS 5156	Bolt for storm protection - Bolzen für sturmleiste - Boulon pour latte anti-tempete - Bullone x asta protezione vento - Bout voor stormankerlat - Puidupolt tormikinnitusliistule 	10	6x70	
DFS 5125	Washer for storm protection - Dichtscheibe für sturmleiste - Rondelle pour latte anti-tempete - Rondella x asta protezione vento - Afdichtring voor storm strip - Seib tormikinnitusliistule 	10	D6	
	Window - Fenster - Fenetre - Finestra - Raam - Aken 710x1224 AK.1.106.SSP	1		
	Window - Fenster - Fenetre - Finestra - Raam - Aken 710x1224 AK.1.106.SSV	1		
38613	Door - Tür - Porte - Porte - Deur - Uks 1494x1850 TUK.2.056.SVP.MMW5c SGC+0	1		

Pos	Piece list - Stückliste - Liste des pièces - Elementi - Stuklijst - Tükitalabel	1/1	Q	P (mm)	L (mm)
	<p>Glass size - Glasgröße - Taille de la vitre - Misura del vetro - Glas afmeting - Klaasi mõõt: 566x1080 mm</p> 				
FS1	<p>Window handle fittings - Fenstergriff - Poignee de fenetre - Maniglia c/ferramenta - Raamhendel -/grendel -/klink - Aknalink</p> 		2		
FSP	<p>Bolt for window handle fittings - Bolzen für fenstergriff beschlag - Vis pour fixation poignee de fenetre - Bullone x apertura manuale finestra - Schroef voor raamhendel - Akna käepideme polt</p> 		4		
HS1	<p>Screw for georgian bars - Schraube für sprossen - Vis pour croisillons - Viti per unire la griglia georgiana della finestra - Schroeven voor raamverdeling - Kruvi akna petfeliistule</p> 		6	2.5x20	

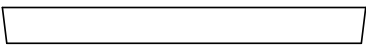
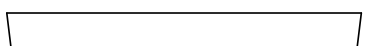
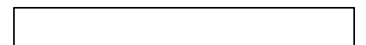
Pos	Piece list - Stückliste - Liste des pièces - Elementi - Stuklijst - Tükitalabel	1/1	Q	P (mm)	L (mm)
	<p>Glass size - Glasgröße - Taille de la vitre - Misura del vetro - Glas afmeting - Klaasi mõõt: 566x1080 mm</p>   <p>610x1124 mm</p>				
FS1	<p>Window handle fittings - Fenstergriff - Poignee de fenetre - Maniglia c/ferramenta - Raamhendel -/grendel -/klink - Aknalink</p> 		2		
FSP	<p>Bolt for window handle fittings - Bolzen für fenstergriff beschlag - Vis pour fixation poignee de fenetre - Bullone x apertura manuale finestra - Schroef voor raamhendel - Akna käepideme põlt</p> 		4		
HS1	<p>Screw for georgian bars - Schraube für sprossen - Vis pour croisillons - Viti per unire la griglia georgiana della finestra - Schroeven voor raamverdeling - Kruvi akna petteliistule</p> 		6	2.5x20	

Pos	26.03.2019	Piece list - Stückliste - Liste des pièces - Elementi - Stuklijst - Tükitalabel	1/2	Q	P (mm)	L (mm)
		<p>Glass size - Glasgröße - Taille de la vitre - Misura del vetro - Glas afmeting - Klaasi mõõt: 514x855 mm</p>  <p>1398x1794mm</p>				
1		<p>Left door jamb - Türrahmen links - Cadre de porte gauche - Telaio montante sinistro della porta - Linkerstijl deurframe - Ukse vasak leng</p> 		1	102x97	1850
1		<p>Right door jamb - Türrahmen rechts - Cadre de porte droit - Telaio montante destro della porta - Rechterstijl deurframe - Ukse parem leng</p> 		1	102x97	1850
2		<p>Upper door jamb - Türrahmen oben - Cadre de porte supérieur - Telaio superiore della porta - Bovendorpel - Ukse ülemine leng</p> 		1	77x38	1518
3		<p>Covering moulding - Deckungsprofil - Profils de finition verticaux a fixer a l'exterieur du cadre de la porte - Cornice di finitura - Afdek profiel - Lengi piirdetaud</p> 		4	28x50	1835
4		<p>Covering moulding - Deckungsprofil - Profils de finition verticaux a fixer a l'exterieur du cadre de la porte - Cornice di finitura - Afdek profiel - Lengi piirdetaud</p> 		2	28x70	94
5		<p>Covering moulding - Deckungsprofil - Profils de finition verticaux a fixer a l'exterieur du cadre de la porte - Cornice di finitura - Afdek profiel - Lengi piirdetaud</p> 		2	28x70	66
6		<p>Covering moulding - Deckungsprofil - Profils de finition verticaux a fixer a l'exterieur du cadre de la porte - Cornice di finitura - Afdek profiel - Lengi piirdetaud</p> 		1	28x70	1469
7		<p>Covering moulding - Deckungsprofil - Profils de finition verticaux a fixer a l'exterieur du cadre de la porte - Cornice di finitura - Afdek profiel - Lengi piirdetaud</p> 		1	28x70	1526
8		<p>Connection strip - Deckleiste - Baguette de battement - Profilo verticale della porta - Stulplijst - Kokkuvalttsiliist</p> 		1	13x32	1820
9		<p>Doorstep - Swelle - Barre de seuil - Soglia della porta - Deurdorpel - Lävepak</p> 		1	18x77	1418

Pos	02.07.2012	Piece list - Stückliste - Liste des pièces - Elementi - Stuklijst - Tükítabel Flower box - Blumenkasten - Jardiniere - Fioriera - Bloembak - Lillekast	1/1	Q.	P (mm)	L (mm)
ES1				1	18x90	906
ES2				1	18x90	884
TS				1	18x140	846
PL				3	18x140	201
KL				2	18x140	200
SH100	Screw for flower box - Montagschraube für blumentasten - Vis assemblage des jardinières - Viti per fioriera - Montageschroeven voor bloembak - Kruvi lillekasti montaažiks			28	3.5x50	
SH100	Screw for fixing flower box to the walls - Schraube zur Befestigung den blumenkasten - Vis de fixation au mur des jardinières - Viti per fissare la fioriera alle pareti - Schroeven voor bevestiging bloembak met wand - Kruvi lillekasti kinnitamiseks seinale			3	4x40	

