

4018211 206018

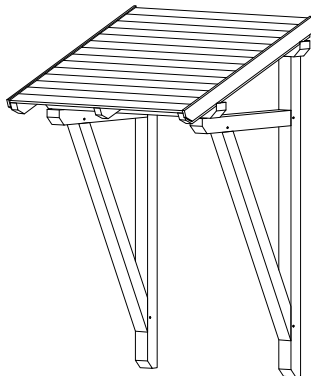

4018211 206025

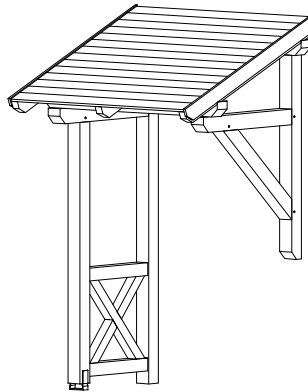

4018211 206032

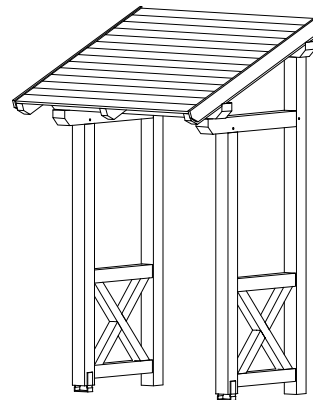

4018211 206049

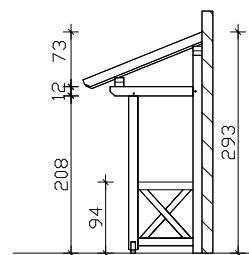
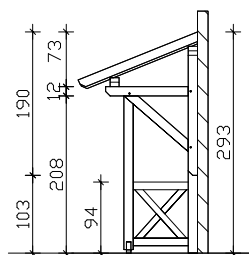
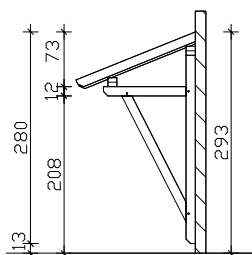
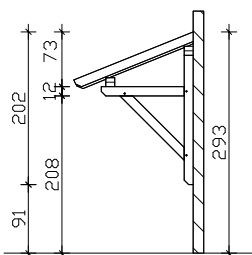

Seitenansichten

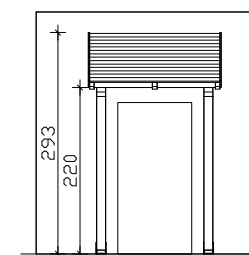
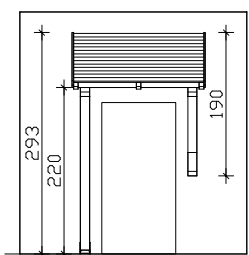
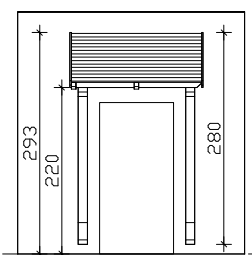
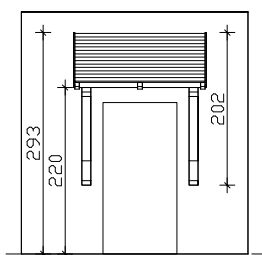

Frontansichten

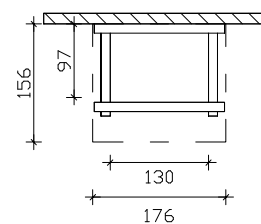
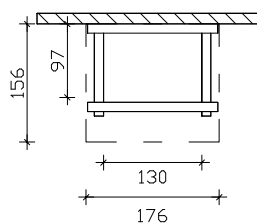
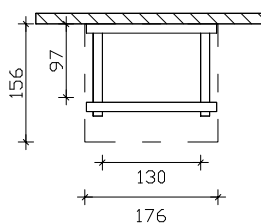
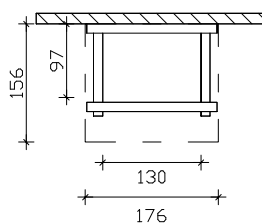

Grundrisse

M 1:100

### Potsdam Vordach Pultdach Datenblatt / Baubeschreibung

<b>Holzart / Eisenteile</b>	<b>Nadelholz, unbehandelt / verzinkt</b>
<b>Pfosten / Sparren</b>	<b>12x12cm / 6x12cm</b>
<b>Dacheindeckung</b>	<b>Schalung 2x12cm / Dachneigung 22°</b>
<b>Breite x Tiefe</b>	<b>176cm x 156cm (überdachte Fläche)</b>
<b>Höhe / Durchgang</b>	<b>293cm / 220cm (Objekthöhen 202cm / 280cm / 293cm / 293cm)</b>
<b>Verpackungseinheit</b>	<b>B x L x H 112 x 260-310 x 30cm</b>
<b>Gewicht</b>	<b>150kg / 170kg / 180kg / 205kg</b>
<b>Inklusive</b>	<b>Montagematerial, Kopfbänder, Aufbauanleitung (ohne Dübel zur Wandbefestigung, ohne Wandabdichtungsprofile)</b>