

OUTDOOR

2024

NARDI



OUTDOOR

2024

design Raffaello Galotto



Scenografie all'aria aperta

Vivere all'aria aperta, con lo sguardo rivolto verso il mare, immersi nel verde o in un'oasi in città. Suggestioni di design e idee per abitare gli spazi esterni, scegliendo tra un vasto numero di collezioni, misure e colori.

I nostri arredi celebrano il desiderio di relax all'aperto, definiscono gli ambienti contemporanei con stile e personalità incontrando le esigenze di componibilità e versatilità.

Li realizziamo completamente in Italia con materiali di qualità adatti a restare all'esterno, sono riciclabili e pensati per un utilizzo intensivo e un lungo ciclo di vita.

Outdoor settings

Living in the open air, with a view of the sea, surrounded by greenery or in a green oasis in the city. Stylish design solutions and ideas for outdoor living, allowing you to choose from a large number of collections, dimensions and colours.

Our furniture enhances the desire to relax outdoors, adding style and personality to contemporary environments while meeting the need for modularity and versatility.

We make our furniture entirely in Italy using high-quality materials suited to remaining outdoors. It is recyclable and designed for intensive use and a long life cycle.

index

10/
TEVERE *SYSTEM*

22/
RIO *SYSTEM*

36/
SET RIO BENCH ALU

42/
ALLORO *SYSTEM*

50/
NET *COLLECTION*

64/
DOGA *COLLECTION*

74/
FOLIO

84/
KOMODO *MODULAR SYSTEM*

102/
ARIA

108/
ATLANTICO

119/
TECHNICAL DETAILS



TEVERE SYSTEM

Products:
TEVERE 210 /
DOGA / TRILL

Fluido e dinamico, il nuovo tavolo allungabile Tevere presenta linee morbide, assenza di spigoli e forme affusolate. Effetti cromatici raffinati grazie a inediti colori abbinabili a diverse tipologie di sedute, per un codice estetico che interpreta i canoni dell'arredo outdoor contemporaneo.

Fluid and dynamic, Tevere, the new extensible table, features soft lines and tapered shapes, with no sharp edges. Refined chromatic effects thanks to brand-new colours for use with various types of chair, thereby creating an aesthetic code that represents the concepts of contemporary outdoor furniture.





TEVERE 210 EXTENSIBLE corda _ DOGA ARMCHAIR menta _ DOGA BISTROT menta



TEVERE 210 EXTENSIBILE corda_ DOGA ARMCHAIR menta_ DOGA BISTROT menta



TEVERE 210 EXTENSIBLE terra _ DOGA ARMCHAIR marsala _ DOGA BISTROT marsala



TEVERE 210 EXTENSIBLE terra

TEVERE 210 EXTENSIBILE tortora _ TRILL ARMCHAIR rosa bouquet _ TRILL BISTROT rosa bouquet





TEVERE 210 EXTENSIBLE tortora _ TRILL ARMCHAIR rosa bouquet _ TRILL BISTROT rosa bouquet



RIO SYSTEM

Products:

RIO 210 / RIO ALU 210 /
RIO 140 / RIO ALU 140 /
DOGA / TRILL / NET

Chiacchierare, ridere, raccontare, trovare sempre un posto per chi arriva all'improvviso. Tavoli allungabili dalla movimentazione facile e invisibile, sedute di diverse forme, colori e gradi di comfort che permettono di creare scenografie outdoor su misura.

Chatting, laughing and telling stories, always finding a place for those who turn up unexpectedly. Tables that extend with a simple concealed movement and chairs in various shapes, colours and levels of comfort that allow you to create customised outdoor settings.





RIO ALU 210 EXTENSIBLE tortora _ DOGA ARMCHAIR agave _ DOGA BISTROT -agave
DOGA RELAX menta - agave _ DOGA TABLE menta _ SIPARIO 3 terra



RIO ALU 210 EXTENSIBLE antracite _ TRILL ARMCHAIR agave



RIO ALU 210 EXTENSIBILE antracite



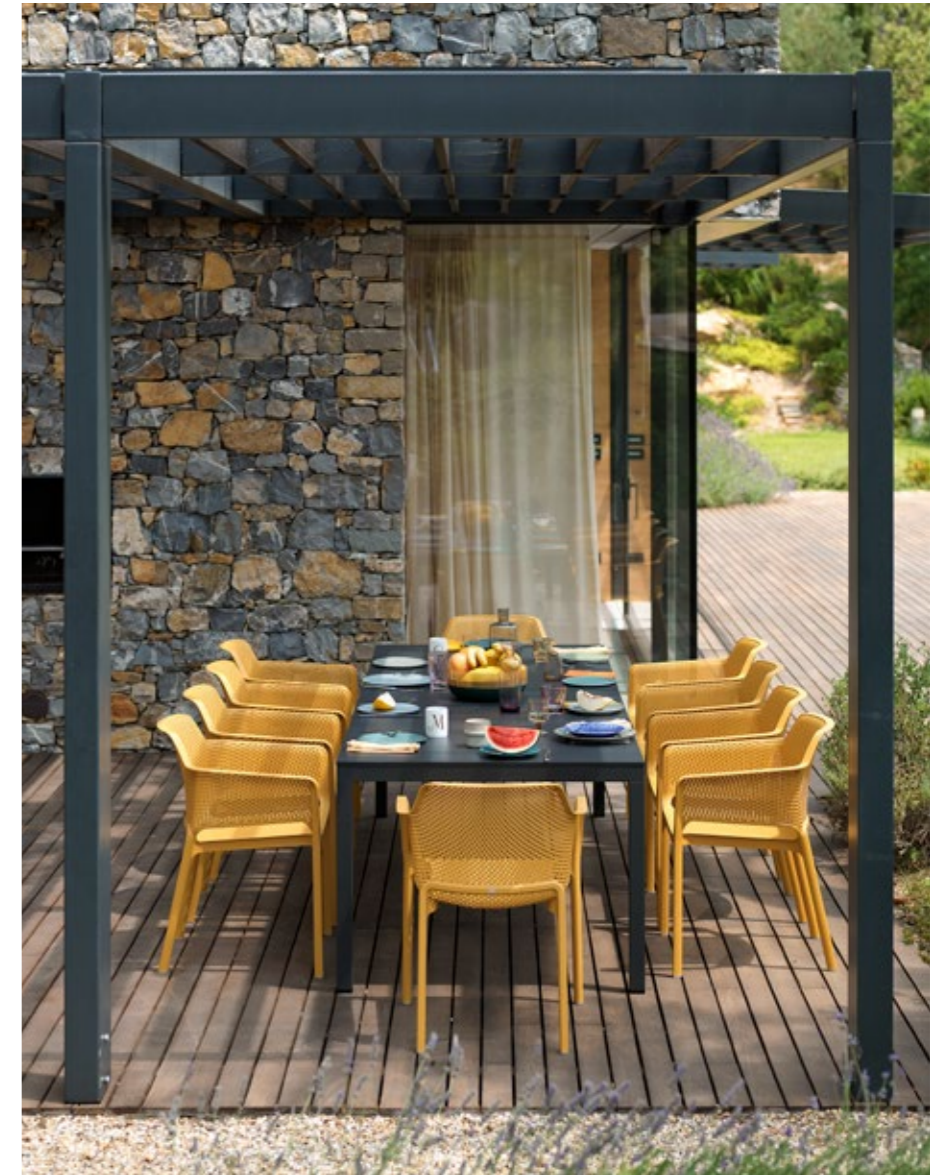

RIO ALU 210 EXTENSIBLE antracite _ NET senape



RIO EXTENSIBLE bianco

RESIN TOP 25mm



RIO ALU EXTENSIBLE bianco

ALUMINIUM TOP 15mm



RIO ALU 140 EXTENSIBLE bianco _ NET bianco / senape _ BIT bianco

SET RIO BENCH ALU

Products:
SET RIO BENCH ALU /
RIO BENCH ALU

Nuove e informali idee per godere della convivialità a cielo aperto.
La panca Rio Bench riprende le caratteristiche doghe del tavolo allungabile Rio e definisce gli ambienti outdoor in totale libertà accendendo la spensieratezza e la voglia di stare insieme.

*New, informal ideas for enjoying convivial moments outdoors.
Rio Bench echoes the characteristic slats of the extensible Rio table, freely creating outdoor environments while fostering light-heartedness and the desire to be together.*





SET RIO BENCH ALU tortora



RIO BENCH ALU tortora



SET RIO BENCH ALU tortora

ALLORO SYSTEM

Products:
ALLORO 210 / ALLORO 140 /
PALMA

Versatilità e facilità d'utilizzo sono le connotazioni dei tavoli allungabili Nardi che vantano alte prestazioni e disegnano conviviali scenari nel nome di tecnica e design. Le armoniose silhouette della struttura dei tavoli e delle sedute abbinate evocano quelle dei classici listelli di legno.

Nardi's extending tables are versatile and easy to use, offering high performance while creating convivial arrangements focused on technology and design. The harmonious silhouettes of the table frames and matching chairs are reminiscent of classic wooden slats.



ALLORO 210 EXTENSIBILE tortora / tortora _ PALMA tortora / tortora





ALLORO 210 EXTENSIBILE tortora / tortora _ PALMA tortora / tortora



ALLORO 140 EXTENSIBILE bianco / tortora _ PALMA bianco / tortora

NET COLLECTION

Products:

NET LOUNGE / NET BENCH /
NET RELAX / NET / BIT /
NET TABLE



Raffinato relax, interpretato da armoniche palette di colori che si compongono e contrappongono in un gioco di elementi - poltroncine, divanetti, tavoli, cuscini e la nuova poltroncina lounge - che dialogano tra loro per originali salotti open air.

Refined relaxation is expressed with harmonious colour palettes that are combined and contrasted in an interplay of elements - armchairs, sofas, tables, cushions and the new lounge chair - that come together to create original outdoor lounges.









NET LOUNGE senape _ SPRITZ tortora

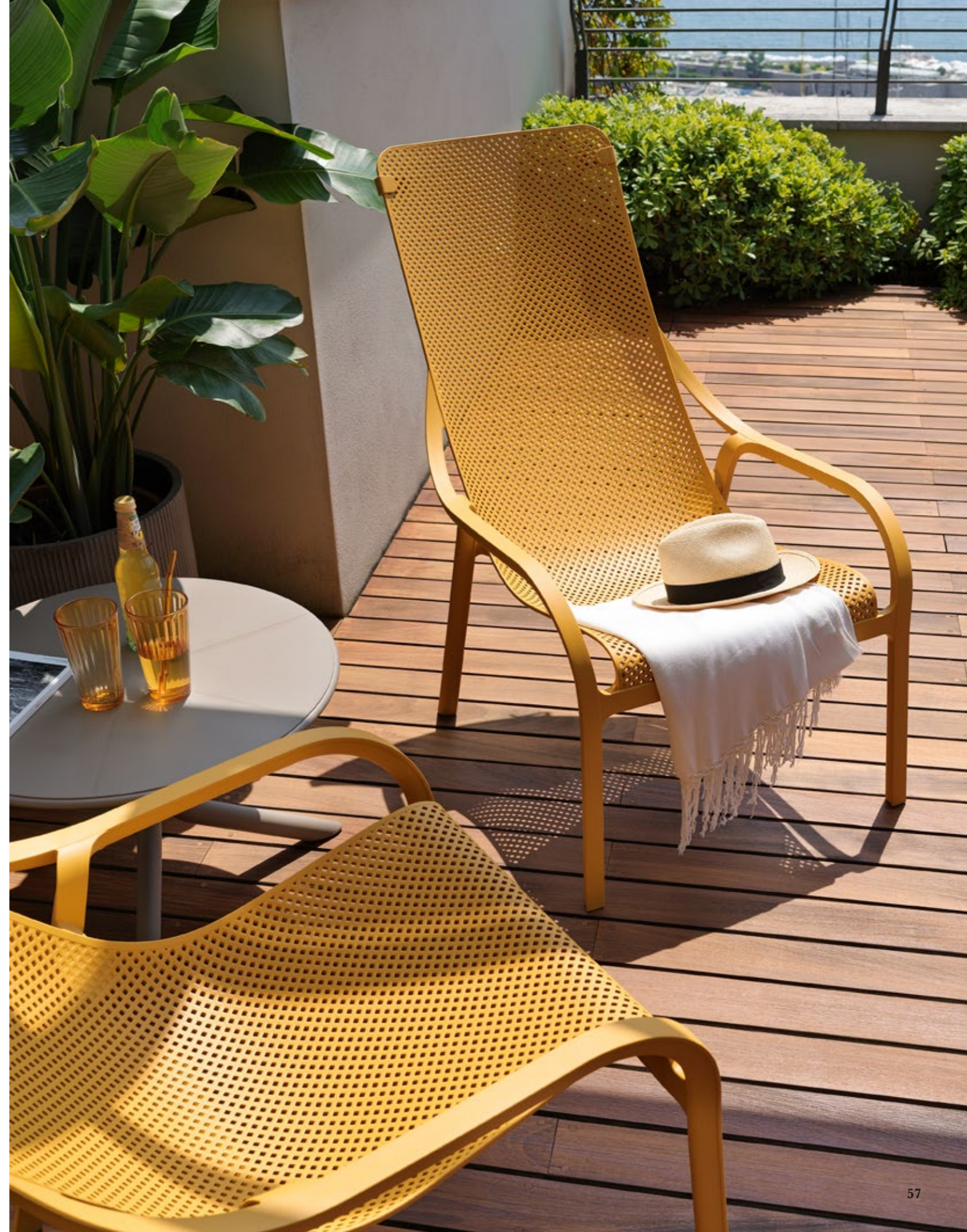



NET BENCH salice / sardinia _ NET RELAX salice / sardinia _ NET TABLE 100 salice



NET RELAX salice / sardinia



NET TABLE 100 salice



DOGA COLLECTION

Products:

DOGA RELAX / DOGA ARMCHAIR /
DOGA BISTROT / DOGA TABLE



reddot winner 2022

Inediti cromatismi, estetica e funzionalità, forme invitanti per godere della vita all'aria aperta. Tutta la leggerezza di Doga, sedute con e senza braccioli e versione lounge, per una collezione fresca, dinamica e versatile ispirata al tema della doga reinterpretata in chiave contemporanea.

New colours, aesthetic design and functionality, with attractive shapes for enjoying life in the open air. All the lightness of Doga chairs with and without armrests, and a lounge version for an original, dynamic and versatile collection inspired by a slatted design given a contemporary twist.





DOGA RELAX antracite / fumo _ DOGA TABLE antracite



DOGA RELAX menta - agave _ DOGA TABLE menta _ SIPARIO 3 terra

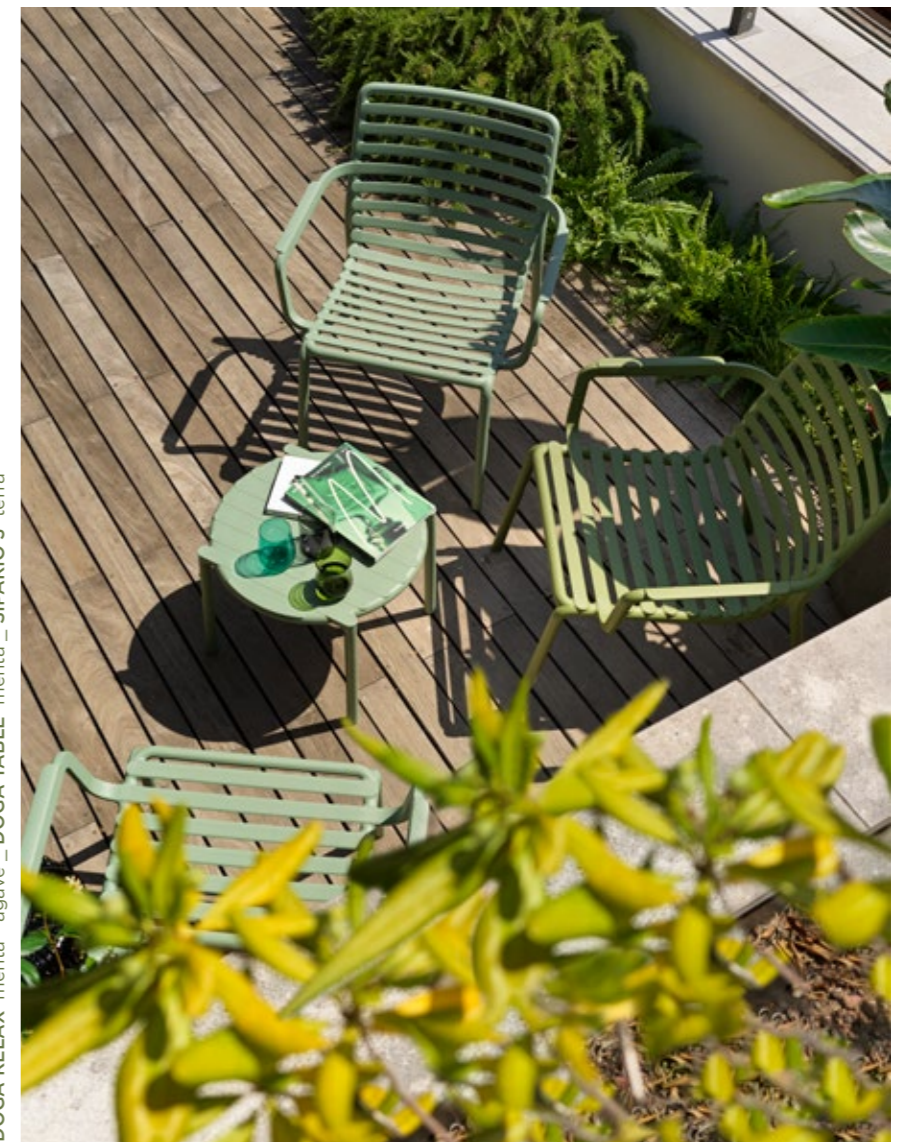



DOGA BISTROT marsala / opera _ DOGA ARMCHAIR marsala / opera _ DOGA RELAX marsala / opera



DOGA ARMCHAIR pera - marsala - cappuccino



DOGA RELAX cappuccino - agave _ DOGA TABLE agave

FOLIO

Products:
FOLIO / FOLIO ROCKING /
POGGIO



Il morbido e piacevole abbraccio di una poltrona davvero speciale.
Folio è un'innovativa poltrona relax proposta a base fissa o nella romantica versione a dondolo, reclinabile in due posizioni e completata dal poggiatesta/sgabello Poggio. Uno stile curato nei dettagli, delineato dall'unione di linee pure, colori e imbottiti per incantevoli angoli di relax.

*The soft and pleasant embrace of a very special armchair.
Folio is an innovative relaxing armchair available with a fixed base or in a romantic rocking version.
It reclines to two positions and can be complemented with the Poggio footrest/stool.
Its style features meticulous details, highlighted by a combination of elegant lines, colours and padded elements that allow charming corners of relaxation to be created.*





FOLIO tortora / felice_ POGGIO tortora









KOMODO MODULAR SYSTEM

Products:
KOMODO / KOMODO TAVOLINO /
KOMODO OMBRA



Sistema di sedute imbottite modulare componibile a piacere per creare il proprio living a cielo aperto. Ispirata all'intreccio dei rami degli alberi, la struttura dona grande personalità all'arredo, accoglie i cuscini in diversi colori e tessuti e si completa con la nuova copertura Ombra per vivere il piacere dell'aria aperta e della socialità protetti dal sole.

A modular upholstered seating system that can be arranged as required to create your open-air living space. Inspired by the lattice pattern of tree branches, its frame adds great character to furnishings, accommodating cushions in various colours and fabrics. Komodo is complemented by the new Ombra covering so you can enjoy the pleasure of being in the open air and socialising, protected from the sun.





KOMODO bianco / rosa quarzo _ KOMODO TAVOLINO bianco



KOMODO agave / avocado - giungla _ KOMODO TAVOLINO agave



KOMODO POLTRONA - agave / avocado - giungla



KOMODO bianco / canvas _ KOMODO TAVOLINO VETRO bianco / vetro





KOMODO tortora / canvas_ KOMODO TAVOLINO VETRO tortora / vetro





ARIA

Products:
ARIA / ARIA TAVOLINO

Progettare salotti all'aperto per godere delle serate in compagnia, della brezza del mare, dell'aria fresca di montagna.
Le doghe, fil rouge stilistico della collezione, disegnano poltroncine e tavolini personalizzabili con una vasta scelta di cuscini di diverse forme e colori.

Creating outdoor lounges for enjoying evenings in company, with a sea breeze or fresh mountain air. Slats, the recurring stylistic theme of the collection, give shape to armchairs and side tables that can be customised with a wide choice of cushions in various shapes and colours.





ARIA TAVOLINO 100 tortora



ARIA POLTRONA tortora / lime



ATLANTICO

Products:
ATLANTICO / POP

Rituali di benessere sia per gli occhi che per il corpo.
Atlantico e Pop uniscono la massima ergonomia alla
qualità di dettagli e materiali.
Un concept estetico dalle linee pure ed essenziali in
un'ampia scelta di colori.

*Rituals of wellbeing for the eyes and the body.
Atlantico and Pop combine excellent ergonomics with
quality details and materials.
An aesthetic concept with simple elegant lines
and a wide choice of colours.*







ATLANTICO tortora / tortora _ POP tortora





ATLANTICO tortora / agave



ATLANTICO tortora / agave _ POP tortora



ATLANTICO bianco / bianco _ POP bianco

**technical
details**

KOMODO

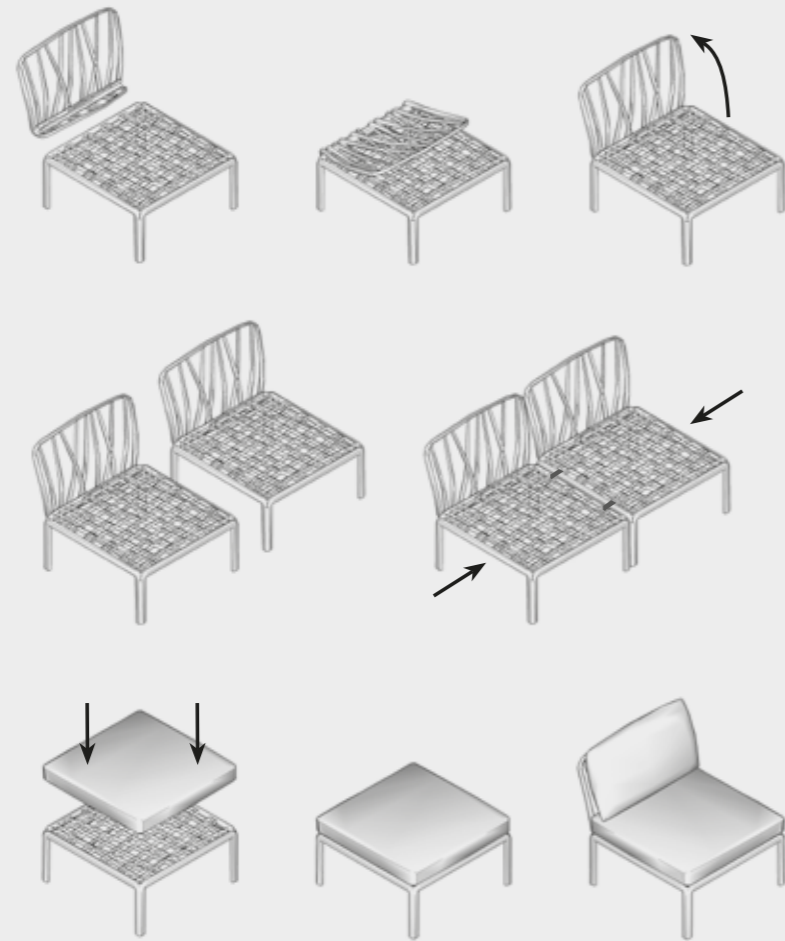

KOMODO è un sistema modulare di sedute configurabile a piacere. I moduli possono essere fissati tra loro e gli schienali e i braccioli sono agganciabili su tutti i lati della seduta. Oltre alla versione standard KOMODO 5, è possibile configurare e ordinare la tua versione personalizzata elencando tutti i singoli elementi che la formano.

KOMODO is a modular system of upholstered seats which can be configured to suit your particular needs. The modules can be secured to one another and the backrests and armrests can be attached on all sides of the seat.

In addition to the standard KOMODO 5 version, you can configure and order your own customized version simply by listing all the individual elements you require.

KOMODO POLTRONA

polypropylene fiberglass fabric

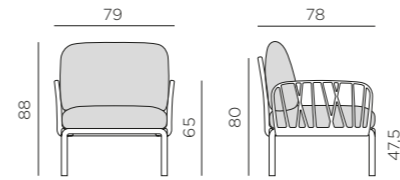

14,3 kg
n. pz. 1



KOMODO ELEMENTO TERMINALE DX/SX

polypropylene fiberglass fabric

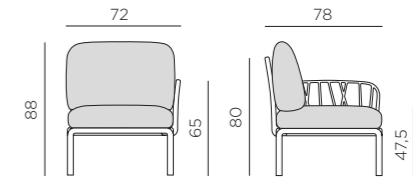

12,6 kg
n. pz. 1



KOMODO ELEMENTO CENTRALE

polypropylene fiberglass fabric

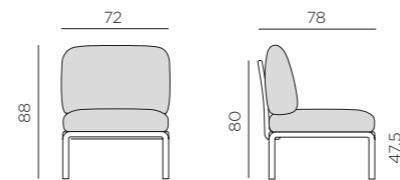

10,9 kg
n. pz. 1



KOMODO ELEMENTO ANGOLO

polypropylene fiberglass fabric

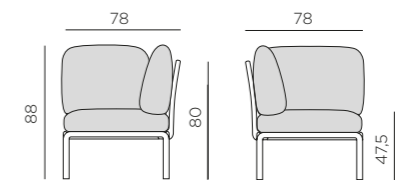

14 kg
n. pz. 1



KOMODO POUF

polypropylene fiberglass fabric

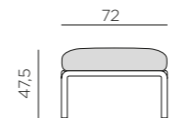

7,5 kg
n. pz. 1



KOMODO 5

polypropylene fiberglass fabric

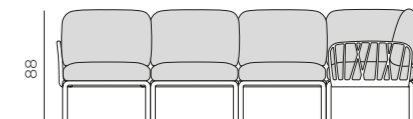
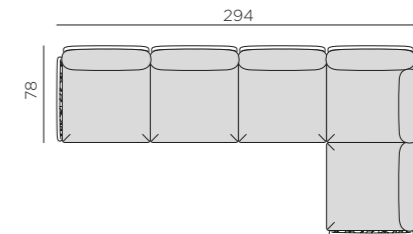

61 kg
n. pz. 1



Life Cycle Assessment

For more information visit: www.nardioutdoor.com/sustainability



	POLTRONA	ELEMENTO TERMINALE DX/SX	ELEMENTO CENTRALE	ELEMENTO ANGOLO	POUF	KOMODO 5
BIANCO rosa quarzo #	40371.00.066	40372.00.066	40373.00.066	40374.00.066	40369.00.066	40370.00.066
ANTRACITE rosa quarzo #	40371.02.066	40372.02.066	40373.02.066	40374.02.066	40369.02.066	40370.02.066
TORTORA rosa quarzo #	40371.10.066	40372.10.066	40373.10.066	40374.10.066	40369.10.066	40370.10.066
AGAVE rosa quarzo #	40371.16.066	40372.16.066	40373.16.066	40374.16.066	40369.16.066	40370.16.066

BIANCO grigio Komodo	40371.00.172	40372.00.172	40373.00.172	40374.00.172	40369.00.172	40370.00.172
ANTRACITE grigio Komodo	40371.02.172	40372.02.172	40373.02.172	40374.02.172	40369.02.172	40370.02.172
TORTORA grigio Komodo	40371.10.172	40372.10.172	40373.10.172	40374.10.172	40369.10.172	40370.10.172
AGAVE grigio Komodo	40371.16.172	40372.16.172	40373.16.172	40374.16.172	40369.16.172	40370.16.172

Variazioni di colore sono da ritenersi standard e naturali nei tessuti acrilici tinto filo. Posizionare in zone d'ombra - Colour variations are to be considered standard and natural in yarn-dyed acrylic fabrics. Position in shaded areas - Les variations de couleur des tissus acryliques au fil teint sont standard et naturelles. Placer dans des zones ombragées - Farbveränderungen sind als Standard und in im Garn gefärbten Acrylgeweben als natürlich zu betrachten. In schattigen Bereichen aufstellen - Las variaciones de color son normales y naturales en las telas acrílicas teñidas en hilo. Colocar en zonas de sombra - As variações de cor são consideradas standard e naturais nos tecidos acrílico tingidos com fio. Posicionar em zonas de sombra - Boyalı akrilik iplik kumaşlarda renk değişiklikleri standart ve doğal kabul edilir. Gölgeli alanlara yerleştiriniz - Изменения цвета следует считать нормой, они являются естественными в случае акриловых тканей с окрашенными волокнами. Размещать в тени



	POLTRONA	ELEMENTO TERMINALE DX/SX	ELEMENTO CENTRALE	ELEMENTO ANGOLO	POUF	KOMODO 5
BIANCO adriatic Sunbrella® *	40371.00.142	40372.00.142	40373.00.142	40374.00.142	40369.00.142	40370.00.142
ANTRACITE adriatic Sunbrella® *	40371.02.142	40372.02.142	40373.02.142	40374.02.142	40369.02.142	40370.02.142
TORTORA adriatic Sunbrella® *	40371.10.142	40372.10.142	40373.10.142	40374.10.142	40369.10.142	40370.10.142
AGAVE adriatic Sunbrella® *	40371.16.142	40372.16.142	40373.16.142	40374.16.142	40369.16.142	40370.16.142

BIANCO ghiaccio Sunbrella® *	40371.00.138	40372.00.138	40373.00.138	40374.00.138	40369.00.138	40370.00.138
ANTRACITE ghiaccio Sunbrella® *	40371.02.138	40372.02.138	40373.02.138	40374.02.138	40369.02.138	40370.02.138
TORTORA ghiaccio Sunbrella® *	40371.10.138	40372.10.138	40373.10.138	40374.10.138	40369.10.138	40370.10.138
AGAVE ghiaccio Sunbrella® *	40371.16.138	40372.16.138	40373.16.138	40374.16.138	40369.16.138	40370.16.138

* Trattamento laminato su richiesta con quantità minima - Laminated finish available on request with a minimum quantity - Traitement laminé sur demande avec une quantité minimum - Laminierter Ausrüstung auf Anfrage mit einer Mindestmenge - Tratamiento laminado bajo pedido con una cantidad mínima - Tratamento laminado sob encomenda com quantidade mínima - Talep üzerine minimum miktarda lamine işlem - Ламинированная обработка по запросу с минимальным количеством



BIANCO avocado Sunbrella® *		40371.00.139	40372.00.139	40373.00.139	40374.00.139	40369.00.139	40370.00.139
ANTRACITE avocado Sunbrella® *		40371.02.139	40372.02.139	40373.02.139	40374.02.139	40369.02.139	40370.02.139
TORTORA avocado Sunbrella® *		40371.10.139	40372.10.139	40373.10.139	40374.10.139	40369.10.139	40370.10.139
AGAVE avocado Sunbrella® *		40371.16.139	40372.16.139	40373.16.139	40374.16.139	40369.16.139	40370.16.139

BIANCO giungla Sunbrella® *		40371.00.140	40372.00.140	40373.00.140	40374.00.140	40369.00.140	40370.00.140
ANTRACITE giungla Sunbrella® *		40371.02.140	40372.02.140	40373.02.140	40374.02.140	40369.02.140	40370.02.140
TORTORA giungla Sunbrella® *		40371.10.140	40372.10.140	40373.10.140	40374.10.140	40369.10.140	40370.10.140
AGAVE giungla Sunbrella® *		40371.16.140	40372.16.140	40373.16.140	40374.16.140	40369.16.140	40370.16.140



BIANCO canvas Sunbrella® *		40371.00.141	40372.00.141	40373.00.141	40374.00.141	40369.00.141	40370.00.141
ANTRACITE canvas Sunbrella® *		40371.02.141	40372.02.141	40373.02.141	40374.02.141	40369.02.141	40370.02.141
TORTORA canvas Sunbrella® *		40371.10.141	40372.10.141	40373.10.141	40374.10.141	40369.10.141	40370.10.141
AGAVE canvas Sunbrella® *		40371.16.141	40372.16.141	40373.16.141	40374.16.141	40369.16.141	40370.16.141

BIANCO TECH panama		40371.00.131	40372.00.131	40373.00.131	40374.00.131	40369.00.131	40370.00.131
ANTRACITE TECH panama		40371.02.131	40372.02.131	40373.02.131	40374.02.131	40369.02.131	40370.02.131
TORTORA TECH panama		40371.10.131	40372.10.131	40373.10.131	40374.10.131	40369.10.131	40370.10.131
AGAVE TECH panama		40371.16.131	40372.16.131	40373.16.131	40374.16.131	40369.16.131	40370.16.131

* Trattamento laminato su richiesta con quantità minima - Laminated finish available on request with a minimum quantity - Traitement laminé sur demande avec une quantité minimum - Laminierte Ausrüstung auf Anfrage mit einer Mindestmenge - Tratamiento laminado bajo pedido con una cantidad mínima - Tratamento laminado sob encomenda com quantidade mínima - Talep üzerine minimum miktarda lamine işlem - Ламинированная обработка по запросу с минимальным количеством

Tessuti disponibili su ordinazione per minimi quantitativi d'ordine - Fabrics available to order for minimum order quantities - Tissus disponibles sur commande de quantités minimales - Gewebe auf Bestellung für Mindestbestellmengen erhältlich - Telas disponibles bajo pedido para cantidades mínimas - Tecidos disponíveis por encomenda para quantidades mínimas de encomenda - Minimum sipariş miktarına göre sipari verilebilecek mevcut kumaşlar - ткани на заказ для минимального объема заказа.

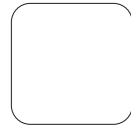

Sunbrella®
+ EXTRA *
p.167

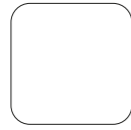

Nardi
Acrylic #
p.166

Variazioni di colore sono da ritenersi standard e naturali nei tessuti acrilici tinto filo. Posizionare in zone d'ombra - Colour variations are to be considered standard and natural in yarn-dyed acrylic fabrics. Position in shaded areas - Les variations de couleur des tissus acryliques au fil teint sont standard et naturelles. Placer dans des zones ombragées - Farbveränderungen sind als Standard und in im Garn gefärbten Acrylgeweben als natürlich zu betrachten. In schattigen Bereichen aufstellen - Las variaciones de color son normales y naturales en las telas acrílicas teñidas en hilo. Colocar en zonas de sombra - As variações de cor são consideradas standard e naturais nos tecidos acrílico tingidos com fio. Posicionar em zonas de sombra - Boyalı akrilik iplik kumaşlarda renk değişiklikleri standart ve doğal kabul edilir. Gölgeli alanlara yerleştiriniz - Изменения цвета следует считать нормой, они являются естественными в случае акриловых тканей с окрашенными волокнами. Размещать в тени

* Trattamento laminato su richiesta con quantità minima - Laminated finish available on request with a minimum quantity - Traitement laminé sur demande avec une quantité minimum - Laminierte Ausrüstung auf Anfrage mit einer Mindestmenge - Tratamiento laminado bajo pedido con una cantidad mínima - Tratamiento laminado sob encomenda com quantidade mínima - Talep üzerine minimum miktarda lamine işlem - Ламинированная обработка по запросу с минимальным количеством

KOMODO BRACCIOLO

polypropylene fiberglass

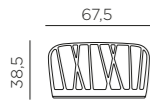

1,7 kg
n. pz. 2

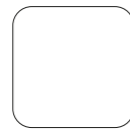

BIANCO
40375.00.000



ANTRACITE
40375.02.000



TORTORA
40375.10.000



AGAVE
40375.16.000

KOMODO SCHIENALE

polypropylene fiberglass

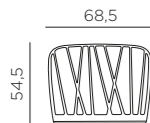

2 kg
n. pz. 4



BIANCO
40376.00.000



ANTRACITE
40376.02.000



TORTORA
40376.10.000



AGAVE
40376.16.000

KOMODO TAVOLINO

polypropylene fiberglass



6,7 kg
n. pz. 1



BIANCO
40378.00.000



ANTRACITE
40378.02.000



TORTORA
40378.10.000



AGAVE
40378.16.000

KOMODO TAVOLINO VETRO

polypropylene fiberglass / glass

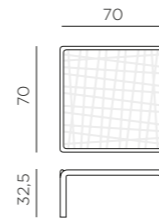

11,4 kg
n. pz. 1



BIANCO
vetro
40368.00.501



ANTRACITE
vetro
40368.02.501



TORTORA
vetro
40368.10.501



AGAVE
vetro
40368.16.501

KOMODO OMBRA 3

polypropylene fiberglass / fabric

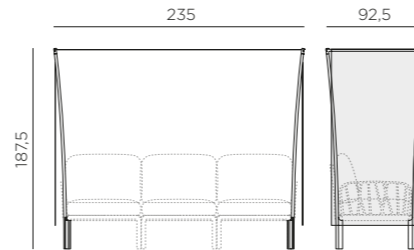

4,7 kg
n. pz. 1



BIANCO
velo white
40408.00.203



ANTRACITE
velo white
40408.02.203



TORTORA
velo white
40408.10.203



AGAVE
velo white
40408.16.203

KOMODO OMBRA 2

polypropylene fiberglass / fabric

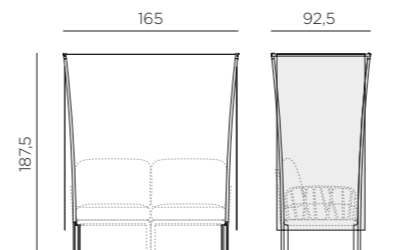

4,6 kg
n. pz. 1



BIANCO
velo white
40407.00.203



ANTRACITE
velo white
40407.02.203



TORTORA
velo white
40407.10.203



AGAVE
velo white
40407.16.203

CUSCINO SCHIENALE KOMODO

fabric

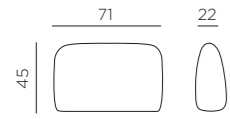

1,4 kg
n. pz. 1

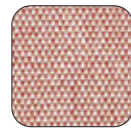

rosa
quarzo #
36370.52.066



grigio
komodo
36370.52.172



adriatic
Sunbrella® *
36370.52.142

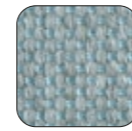

ghiaccio
Sunbrella® *
36370.52.138



avocado
Sunbrella® *
36370.52.139



giungla
Sunbrella® *
36370.52.140



canvas
Sunbrella® *
36370.52.141



TECH
panama
36370.52.131

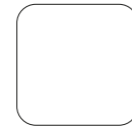

Sunbrella®
+ EXTRA ▲
p. 167

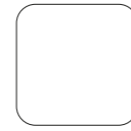

Nardi
Acrylic ▲
p. 166

CUSCINO SCHIENALE ANGOLO KOMODO

fabric

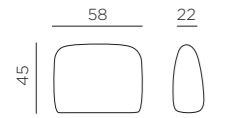

1,1 kg
n. pz. 1

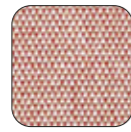

rosa
quarzo #
36370.54.066



grigio
komodo
36370.54.172



adriatic
Sunbrella® *
36370.54.142

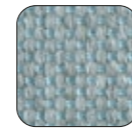

ghiaccio
Sunbrella® *
36370.54.138



avocado
Sunbrella® *
36370.54.139



giungla
Sunbrella® *
36370.54.140



canvas
Sunbrella® *
36370.54.141



TECH
panama
36370.54.131

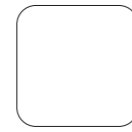

Sunbrella®
+ EXTRA ▲
p. 167

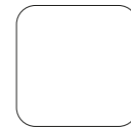

Nardi
Acrylic ▲
p. 166

FOLIO

polypropylene fiberglass

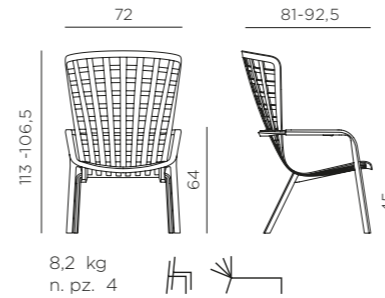

8,2 kg
n. pz. 4



BIANCO
40300.00.000.04



ANTRACITE
40300.02.000.04



TORTORA
40300.10.000.04



AGAVE
40300.16.000.04



TABACCO
40300.53.000.04

KIT FOLIO ROCKING

polypropylene fiberglass

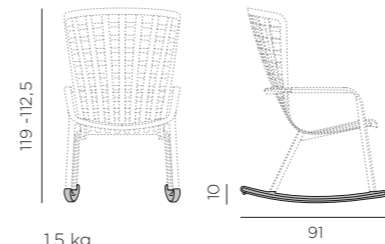

1,5 kg
n. pz. 1

1 KIT= 2 pz

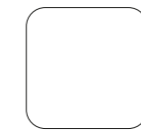

BIANCO
40298.00.000



ANTRACITE
40298.02.000



TORTORA
40298.10.000



AGAVE
40298.16.000



TABACCO
40298.53.000

POGGIO

polypropylene fiberglass

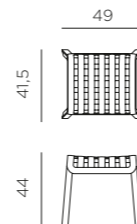

2,7 kg
n. pz. 4



BIANCO
40044.00.000



ANTRACITE
40044.02.000



TORTORA
40044.10.000



AGAVE
40044.16.000



TABACCO
40044.53.000

▲ Sunbrella® e Sunbrella® EXTRA - p. 167 Nardi Acrylic - p. 166

Tessuti disponibili su ordinazione per minimi quantitativi d'ordine - Fabrics available to order for minimum order quantities - Tissus disponibles sur commande de quantités minimales - Gewebe auf Bestellung für Mindestbestellmengen erhältlich - Telas disponibles bajo pedido para cantidades mínimas - Tecidos disponíveis por encomenda para quantidades mínimas de encomenda - Minimum sipariş miktarına göre sipari verilebilecek mevcut kumaşlar - ткани на заказ для минимального объема заказа

Variazioni di colore sono da ritenersi standard e naturali nei tessuti acrilici tinto filo. Posizionare in zone d'ombra - Colour variations are to be considered standard and natural in yarn-dyed acrylic fabrics. Position in shaded areas - Les variations de couleur des tissus acryliques au fil teint sont standard et naturelles. Placer dans des zones ombragées - Farbveränderungen sind als Standard und in im Garn gefärbten Acrylgeweben als natürlich zu betrachten. In schattigen Bereichen aufstellen - Las variaciones de color son normales y naturales en las telas acrílicas teñidas en hilo. Colocar en zonas de sombra - As variações de cor são consideradas standard e naturais nos tecidos acrílico tingidos com fio. Posicionar em zonas de sombra - Boyalı akrilik iplik kumaşlarda renk değişiklikleri standart ve doğal kabul edilir. Gölge alanlara yerleştiriniz - Изменения цвета следует считать нормой, они являются естественными в случае акриловых тканей с окрашенными волокнами. Размещать в тени

* Trattamento laminato su richiesta con quantità minima - Laminated finish available on request with a minimum quantity - Traitement laminé sur demande avec une quantité minimum - Laminierte Ausrüstung auf Anfrage mit einer Mindestmenge - Tratamiento laminado bajo pedido con una cantidad mínima - Tratamento laminado sob encomenda com quantidade mínima - Talep üzerine minimum miktarda lamine işlem - Ламинированная обработка по запросу с минимальным количеством

CUSCINO FOLIO COMFORT

fabric

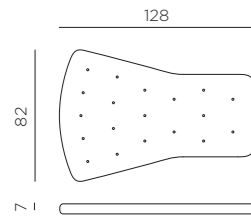

1,4 kg
n. pz. 1

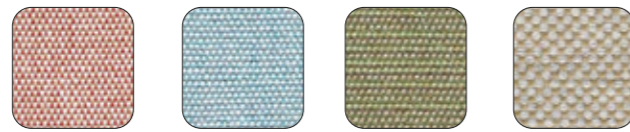

rosa quarzo# 36300.01.066 artic# 36300.01.161 felce# 36300.01.162 lino 36300.01.152

CUSCINO POGGIATESTA FOLIO **new**

fabric

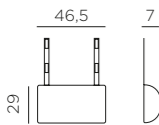

0,3 kg
n. pz. 4

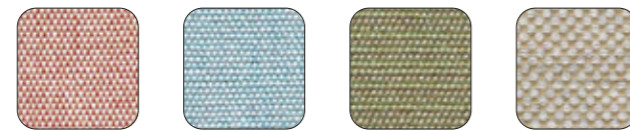

rosa quarzo# 36300.04.066 artic# 36300.04.161 felce# 36300.04.162 lino 36300.04.152

FOLIO

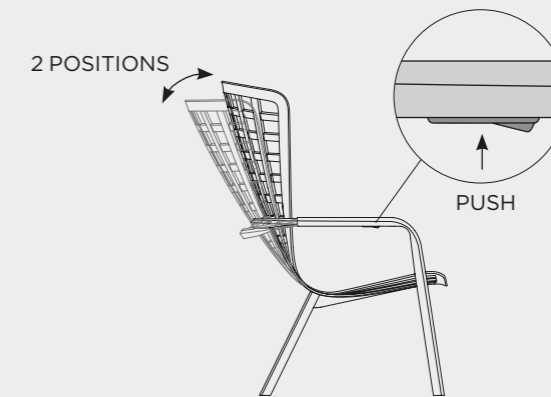

FOLIO ROCKING

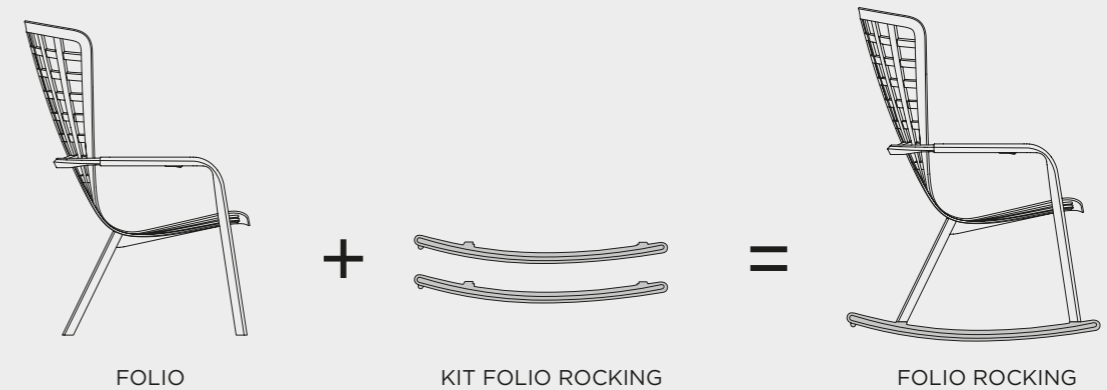

FOLIO è una innovativa poltrona relax a due posizioni pensata per l'outdoor, proposta su base fissa, con poggiatesta, oppure nella romantica versione a dondolo.

L'ampia scocca della poltrona è costituita da un unico foglio dal design sapientemente curvato in modo da permettere il movimento tra seduta e schienale sfruttando l'elasticità del materiale senza l'ausilio di elementi di congiunzione o di rotazione.

FOLIO is an innovative relaxing armchair, adjusting to two positions, designed for outdoor use. It is available with a fixed base and a footrest, or in a romantic rocking version.

The large structure of the armchair is made from a single perforated sheet. It has an expertly curved design that allows movement between the seat and back, exploiting the flexibility of the material without requiring any linking or rotating elements.

Variazioni di colore sono da ritenersi standard e naturali nei tessuti acrilici tinto filo. Posizionare in zone d'ombra - Colour variations are to be considered standard and natural in yarn-dyed acrylic fabrics. Position in shaded areas - Les variations de couleur des tissus acryliques au fil teint sont standard et naturelles. Placer dans des zones ombragées - Farbveränderungen sind als Standard und in im Garn gefärbten Acrylgeweben als natürlich zu betrachten. In schattigen Bereichen aufstellen - Las variaciones de color son normales y naturales en las telas acrílicas teñidas en hilo. Colocar en zonas de sombra - As variações de cor são consideradas standard e naturais nos tecidos acrílico tingidos com fio. Posicionar em zonas de sombra - Boyalı akrilik iplik kumaşlarda renk değişiklikleri standart ve doğal kabul edilir. Gölgeli alanlara yerleştiriniz - Изменения цвета следует считать нормой, они являются естественными в случае акриловых тканей с окрашенными волокнами. Размещать в тени

NET LOUNGE

polypropylene fiberglass

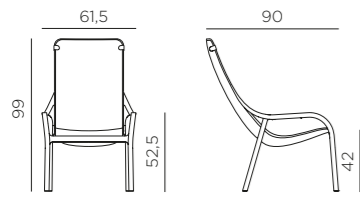

5,3 kg
n. pz. 4



BIANCO 40329.00.000 ANTRACITE 40329.02.000 SALICE 40329.04.000 TORTORA 40329.10.000 SENAPE 40329.56.000 CORALLO 40329.75.000

NET BENCH

polypropylene fiberglass

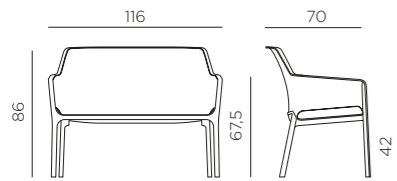

8,9 kg
n. pz. 20



BIANCO 40338.00.000 ANTRACITE 40338.02.000 SALICE 40338.04.000 TORTORA 40338.10.000 SENAPE 40338.56.000 CORALLO 40338.75.000

NET RELAX

polypropylene fiberglass

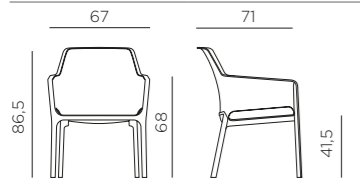

4,9 kg
n. pz. 20 pz. 6



BIANCO 40327.00.000 ANTRACITE 40327.02.000 SALICE 40327.04.000 TORTORA 40327.10.000 SENAPE 40327.56.000 CORALLO 40327.75.000

NET

polypropylene fiberglass

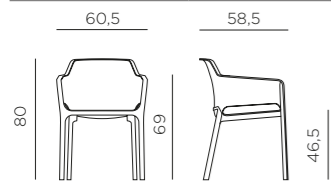

3,9 kg
n. pz. 6 pz. 6



BIANCO 40326.00.000.06 ANTRACITE 40326.02.000.06 SALICE 40326.04.000.06 TORTORA 40326.10.000.06 SENAPE 40326.56.000.06 CORALLO 40326.75.000.06

BIT

polypropylene fiberglass

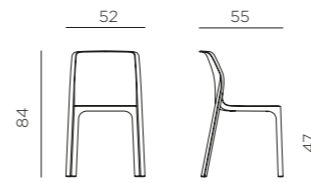

3,5 kg
n. pz. 6



BIANCO 40328.00.000.06 ANTRACITE 40328.02.000.06 SALICE 40328.04.000.06 TORTORA 40328.10.000.06 SENAPE 40328.56.000.06 CORALLO 40328.75.000.06

NET STOOL

polypropylene fiberglass

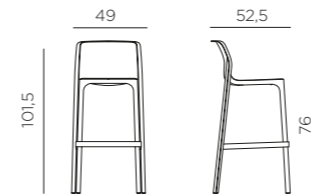

4,4 kg
n. pz. 4



BIANCO 40355.00.000 ANTRACITE 40355.02.000 SALICE 40355.04.000 TORTORA 40355.10.000 SENAPE 40355.56.000 CORALLO 40355.75.000

NET STOOL MINI

polypropylene fiberglass

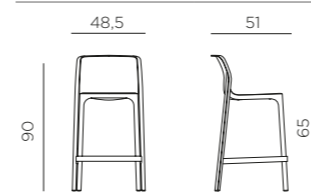

4,2 kg
n. pz. 4



BIANCO 40356.00.000 ANTRACITE 40356.02.000 SALICE 40356.04.000 TORTORA 40356.10.000 SENAPE 40356.56.000 CORALLO 40356.75.000

TRILL ARMCHAIR



polypropylene fiberglass

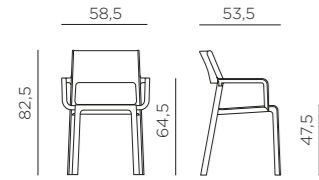

4,7 kg
n. pz. 6



BIANCO 40250.00.000 ANTRACITE 40250.02.000 GRIGIO 40250.03.000 ROSABOUQUET 40250.08.000 TORTORA 40250.10.000 AGAVE 40250.16.000



OTTANIO 40250.49.000 TABACCO 40250.53.000 SENAPE 40250.56.000

TRILL BISTROT

polypropylene fiberglass

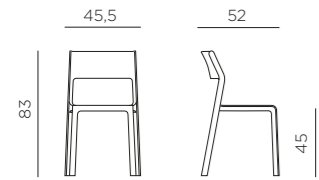

3,8 kg
n. pz. 6



BIANCO 40253.00.000 ANTRACITE 40253.02.000 GRIGIO 40253.03.000 ROSABOUQUET 40253.08.000 TORTORA 40253.10.000 AGAVE 40253.16.000



OTTANIO 40253.49.000 TABACCO 40253.53.000 SENAPE 40253.56.000

TRILL STOOL

polypropylene fiberglass

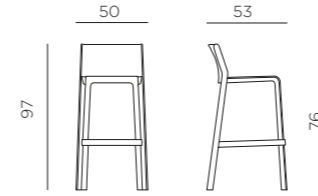

5 kg
n. pz. 4



BIANCO 40350.00.000 ANTRACITE 40350.02.000 GRIGIO 40350.03.000 ROSABOUQUET 40350.08.000 TORTORA 40350.10.000 AGAVE 40350.16.000



OTTANIO 40350.49.000 TABACCO 40350.53.000 SENAPE 40350.56.000

TRILL STOOL MINI

polypropylene fiberglass

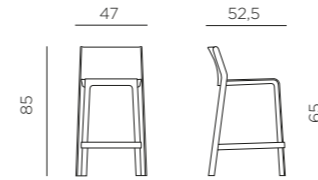

4,6 kg
n. pz. 4



BIANCO 40353.00.000 ANTRACITE 40353.02.000 GRIGIO 40353.03.000 ROSABOUQUET 40353.08.000 TORTORA 40353.10.000 AGAVE 40353.16.000



OTTANIO 40353.49.000 TABACCO 40353.53.000 SENAPE 40353.56.000



Life Cycle Assessment

For more information visit: www.nardioutdoor.com/sustainability

EPD® dichiarazione ambientale di prodotto/ environmental product declaration

DOGA RELAX

polypropylene fiberglass

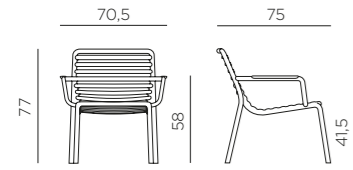

6 kg
n. pz. 4



BIANCO 40256.00.000 ANTRACITE 40256.02.000
CAPPUCCINO 40256.14.000 MENTA 40256.15.000
AGAVE 40256.16.000 PERA 40256.18.000



MARSALA 40256.21.000
TABACCO 40256.53.000

DOGA ARMCHAIR

polypropylene fiberglass

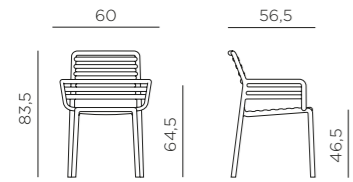

5,1 kg
n. pz. 6



BIANCO 40254.00.000 ANTRACITE 40254.02.000
CAPPUCCINO 40254.14.000 MENTA 40254.15.000
AGAVE 40254.16.000 PERA 40254.18.000



MARSALA 40254.21.000
TABACCO 40254.53.000

DOGA BISTROT

polypropylene fiberglass

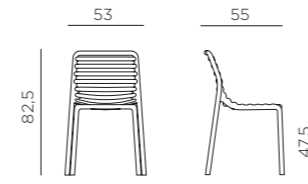

4,1 kg
n. pz. 6



BIANCO 40255.00.000 ANTRACITE 40255.02.000
CAPPUCCINO 40255.14.000 MENTA 40255.15.000
AGAVE 40255.16.000 PERA 40255.18.000



MARSALA 40255.21.000
TABACCO 40255.53.000

DOGA STOOL **new**

polypropylene fiberglass

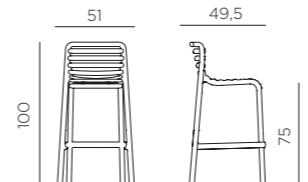

5,1 kg
n. pz. 4



BIANCO 40348.00.000 ANTRACITE 40348.02.000
CAPPUCCINO 40348.14.000 MENTA 40348.15.000
AGAVE 40348.16.000 PERA 40348.18.000



MARSALA 40348.21.000
TABACCO 40348.53.000

PALMA

polypropylene

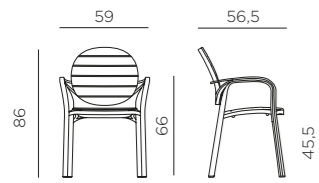

5,2 kg
n. pz. 6



BIANCO 40237.00.000
BIANCO TORTORA 40237.00.010
ANTRACITE 40237.02.002
TORTORA 40237.10.010

ERICA

polypropylene

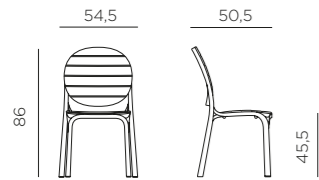

4,1 kg
n. pz. 6



BIANCO 40236.00.000
BIANCO TORTORA 40236.00.010
ANTRACITE 40236.02.002
TORTORA 40236.10.010

ARIA (POLTRONA ARIA + CUSCINO SEDUTA + CUSCINO ARREDO)

polypropylene / fabric

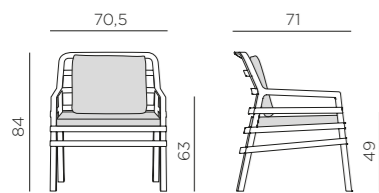

7,9 kg
n. pz. 1



BIANCO lime # 40330.00.061.061
BIANCO sardinia # 40330.00.072.072
BIANCO grigio # 40330.00.163.163
BIANCO grigio Sunbrella® 40330.00.136.136
TORTORA lime # 40330.10.061.061

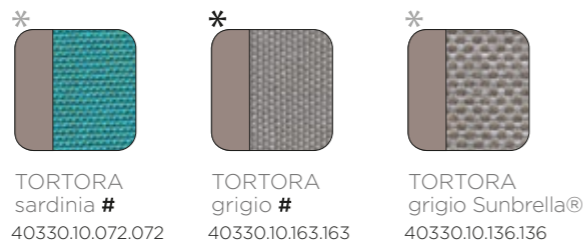

TORTORA sardinia # 40330.10.072.072
TORTORA grigio # 40330.10.163.163
TORTORA grigio Sunbrella® 40330.10.136.136

* Disponibile a magazzino
Available ex-stock
Disponibile sur stock
Ab Lager verfügbar
Disponibile en almacén habitualmente
Disponível em estoque
Stokta mevcut
Наличие на складе

* Disponibile su ordine
Available to order
Disponibile sur commande
Mit Auftrag verfügbar
Disponibile sólo sobre pedido
Disponível sob encomenda
Sipariş göre hazırlanacaktır
Под заказ

Variazioni di colore sono da ritenersi standard e naturali nei tessuti acrilici tinto filo. Posizionare in zone d'ombra - Colour variations are to be considered standard and natural in yarn-dyed acrylic fabrics. Position in shaded areas - Les variations de couleur des tissus acryliques au fil teint sont standard et naturelles. Placer dans des zones ombragées - Farbveränderungen sind als Standard und in im Garn gefärbten Acrylgeweben als natürlich zu betrachten. In schattigen Bereichen aufstellen - Las variaciones de color son normales y naturales en las telas acrílicas teñidas en hilo. Colocar en zonas de sombra - As variações de cor são consideradas standard e naturais nos tecidos acrílico tingidos com fio. Posicionar em zonas de sombra - Boyalı akrilik iplik kumaşlarda renk değişiklikleri standart ve doğal kabul edilir. Gölgeli alanlara yerleştiriniz - Изменения цвета следует считать нормой, они являются естественными в случае акриловых тканей с окрашенными волокнами. Размещать в тени

ATLANTICO

polypropylene fiberglass / synthetic fabric

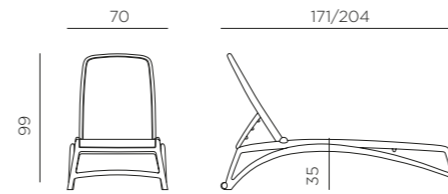

16 kg
n. pz. 20



Tessuto ricambiabile
Replaceable fabric
Tissu changeable
Auswechselbarer Stoff
Tela sustituible
Tecidos recambiáveis
Değiştirilebilen Kumaş
Съемная ткань

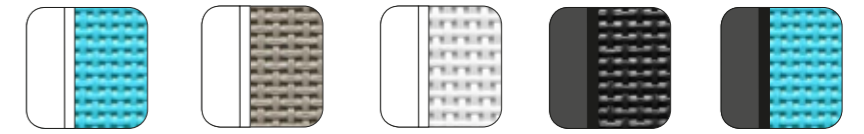

BIANCO celeste 40450.00.075
BIANCO tortora 40450.00.104
BIANCO bianco 40450.00.107
ANTRACITE antracite 40450.02.057
ANTRACITE celeste 40450.02.075

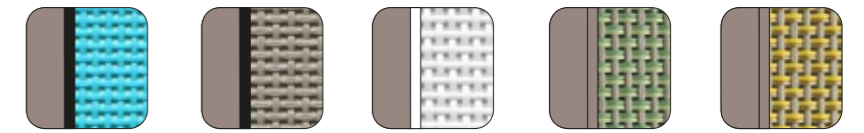

TORTORA celeste 40450.10.075
TORTORA tortora 40450.10.104
TORTORA bianco 40450.10.107
TORTORA agave 40450.10.101
TORTORA deserto 40450.10.103

BRACCIOLLO ATLANTICO

polypropylene fiberglass

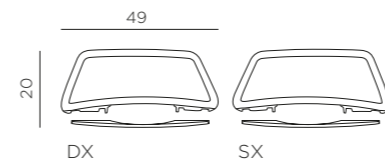

1,1 kg
n. pz. 1

1 KIT = 2 pz (1DX+1SX)



BIANCO 40452.00.000
ANTRACITE 40452.02.000
TORTORA 40452.10.000

RICAMBIO ATLANTICO

acetalic resin / synthetic fabric

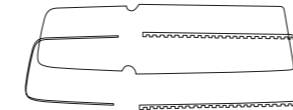

1,3 kg
n. pz. 1

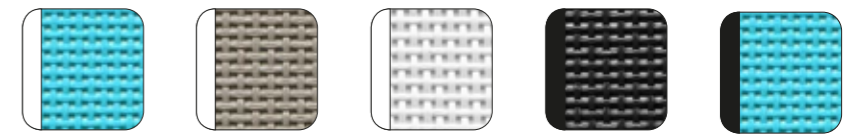

celeste 40460.00.075
tortora 40460.00.104
bianco 40460.00.107
antracite 40460.01.057
celeste 40460.01.075

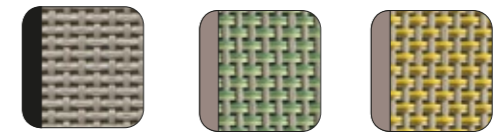

tortora 40460.01.104
agave 40460.10.101
deserto 40460.10.103

TEVERE

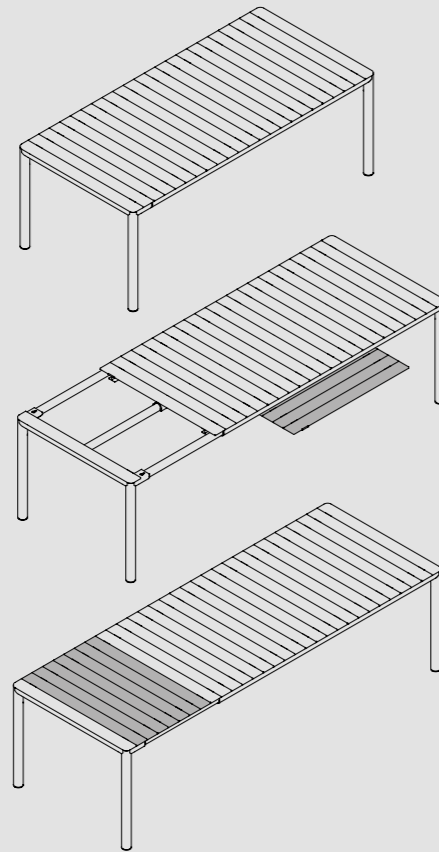

tevere 210 extensibile
8/10 211/275x100x76,5 cm

TEVERE 210 EXTENSIBLE 8/10 new

regenerated polypropylene fiberglass / aluminium
polypropylene fiberglass / aluminium

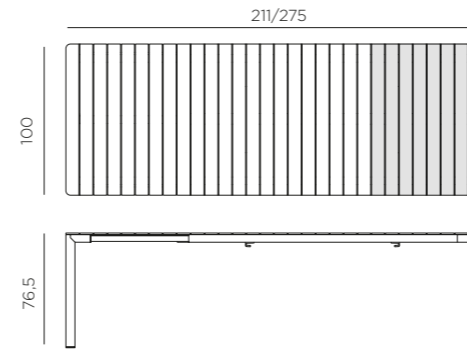

53 kg
n. pz. 1

regenerated



TERRA ✱
verniciato terra
49668.44.000

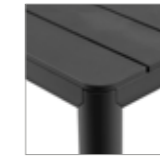

ANTRACITE ✱
verniciato antracite
49652.02.000



TORTORA
verniciato tortora
49659.10.000



CORDA
verniciato corda
49669.24.000

✱ Posizionare in zone d'ombra - Position in shaded areas - Placer dans des zones ombragées - In schattigen Bereichen aufstellen - Colocar en zonas de sombra - Posicionar em zonas de sombra - Gölge alanlara yerleştiriniz - Размещать в тени

Il polipropilene fiberglass rigenerato può subire delle variazioni di colore dovute all'utilizzo di materiale riciclato - Regenerated fiberglass polypropylene may undergo variations in color due to the use of recycled material - Polypropylène fiberglass régénérée peut subir variations de couleur en raison de l'utilisation de matériaux recyclés - Regeneriertem fiberglass-Polypropylen kann aufgrund der Verwendung von recyceltem Material Farbabweichungen unterliegen - El polipropileno fiberglass regenerado puede sufrir variaciones de color debido al uso de material reciclado - O polipropileno fiberglass regenerado pode sofrer variações de cor devido ao uso de material reciclado - Rejenered edilmiş polipropilen fiberglass, geri dönüşüm malzemesi kullanımı nedeniyle renk değişikliklerine maruz kalabilir - Цвет регенерированного полипропиленового стекловолокна может претерпевать изменения вследствие использования переработанного материала.

RIO

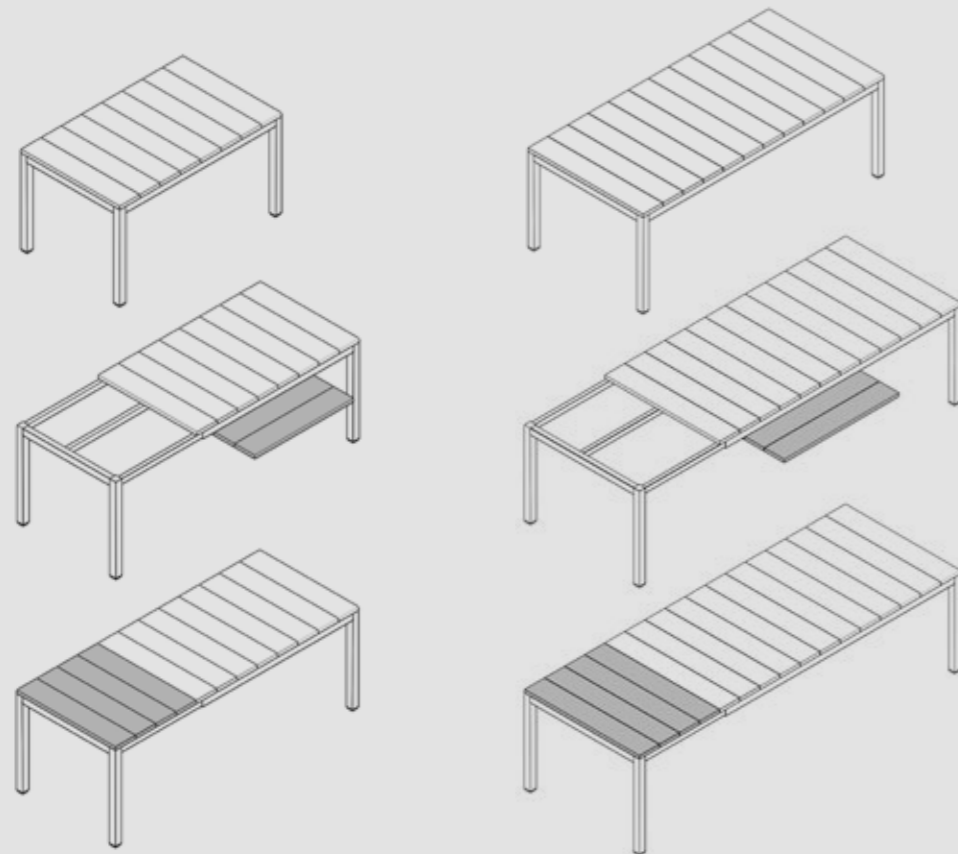

rio 140 extensible
6/8 140/210x85x76 cm

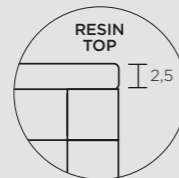

rio 210 extensible
8/10 210/280x100x76 cm

rio **ALU** 140 extensible
6/8 140/210x85x75 cm

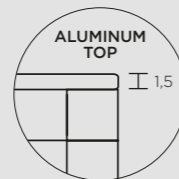

rio **ALU** 210 extensible
8/10 210/280x100x75 cm

RIO **ALU** 210 EXTENSIBLE 8/10

aluminium

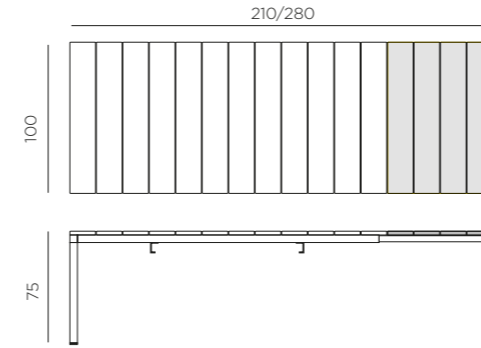

54 kg
n. pz. 1



verniciato bianco
48853.00.000

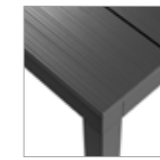

verniciato antracite
48852.02.000



verniciato tortora
48859.10.000

RIO **ALU** 140 EXTENSIBLE 6/8

aluminium

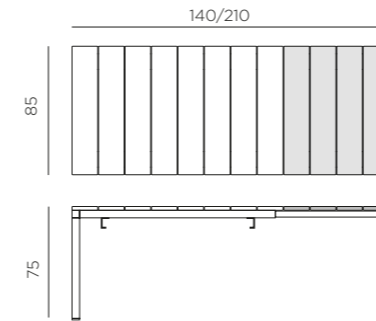

37,1 kg
n. pz. 1

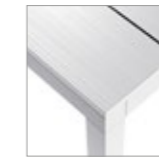

verniciato bianco
48653.00.000

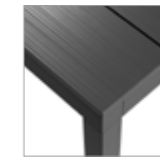

verniciato antracite
48652.02.000



verniciato tortora
48659.10.000

SET RIO BENCH ALU

aluminium

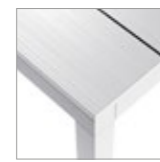
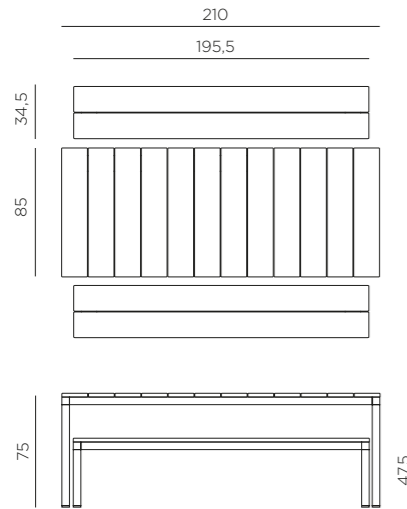

verniciato bianco
49253.00.000

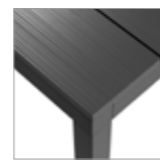

verniciato antracite
49252.02.000



verniciato tortora
49259.10.000

72 kg
n. pz. 3

Il set comprende 1 Rio Alu 210 Fix e 2 Rio Bench Alu
The set includes 1 Rio Alu 210 Fix and 2 Rio Bench Alu
L'ensemble comprend 1 Rio Alu 210 Fix et 2 Rio Bench Alu
Die Garnitur umfasst 1 Rio Alu 210 Fix und 2 Rio Bench Alu

El juego incluye 1 Rio Alu 210 Fix y 2 Rio Bench Alu
O conjunto inclui 1 Rio Alu 210 Fix e 2 Rio Bench Alu
Set içeriğinde 1 Rio Alu 210 Fix ve 2 Rio Bench Alu mevcuttur
Комплект состоит из 1 Rio Alu 210 Fix и 2 Rio Bench Alu

RIO BENCH ALU

aluminium

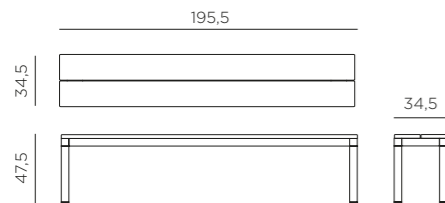

verniciato bianco
49053.00.000

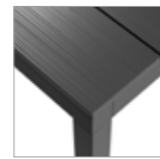

verniciato antracite
49052.02.000



verniciato tortora
49059.10.000

17 kg
n. pz. 1

RIO ALU 210 FIX

aluminium

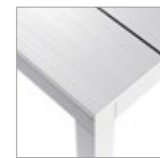
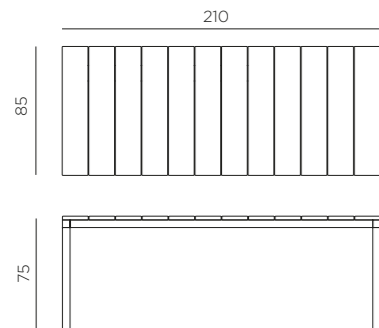

verniciato bianco
49153.00.000

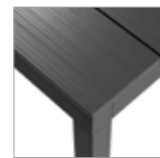

verniciato antracite
49152.02.000



verniciato tortora
49159.10.000

37 kg
n. pz. 1

RIO 210 EXTENSIBLE 8/10

durelTOP / polypropylene / aluminium

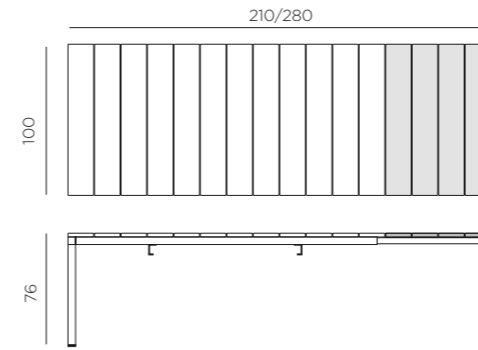

BIANCO
verniciato bianco
48253.00.000

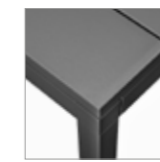

ANTRACITE *
verniciato antracite
48252.02.000



TORTORA
verniciato tortora
48259.10.000

49 kg
n. pz. 1

RIO 140 EXTENSIBLE 6/8

durelTOP / polypropylene / aluminium

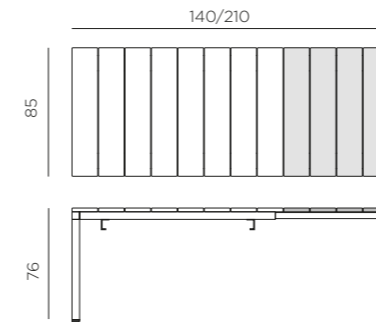

BIANCO
verniciato bianco
48353.00.000

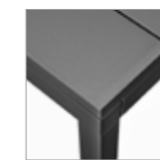

ANTRACITE *
verniciato antracite
48352.02.000



TORTORA
verniciato tortora
48359.10.000

32,6 kg
n. pz. 1

* Posizionare in zone d'ombra - Position in shaded areas - Placer dans des zones ombragées - In schattigen Bereichen aufstellen - Colocar en zonas de sombra - Posicionar em zonas de sombra - Gölge alanlara yerleştiriniz - Размещать в тени

ALLORO

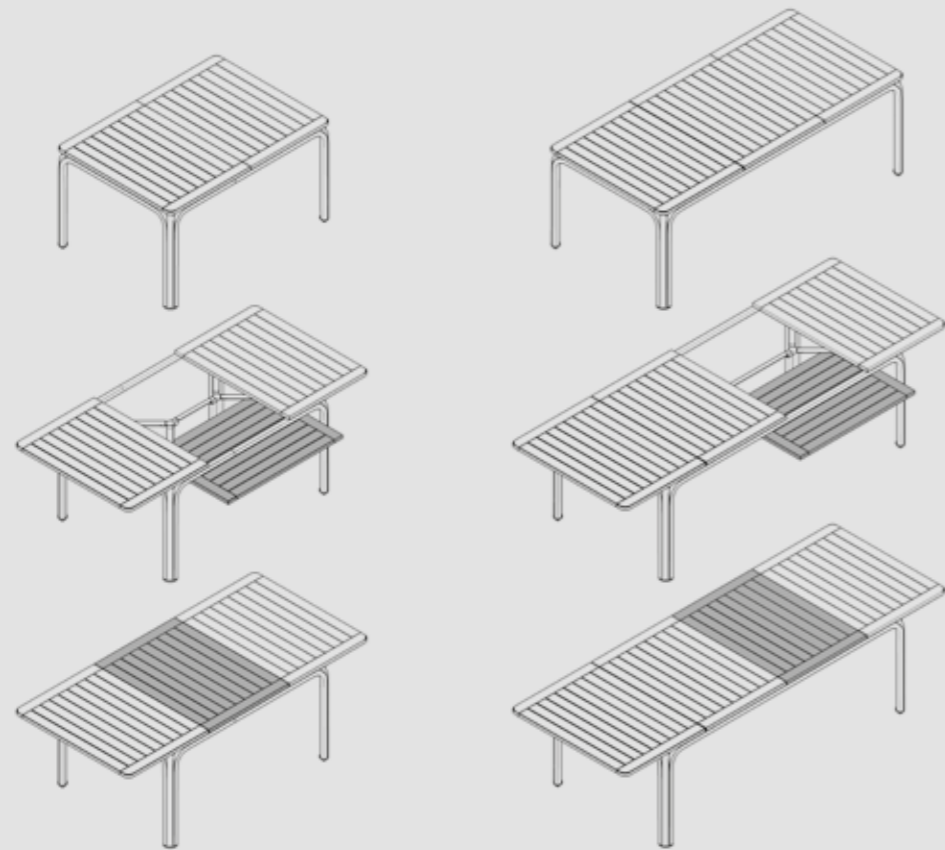

alloro 140 extensible
6/8 140/210x100x73 cm

alloro 210 extensible
8/10 210/280x100x73 cm

ALLORO 210 EXTENSIBLE 8/10

durelTOP / polypropylene / aluminium

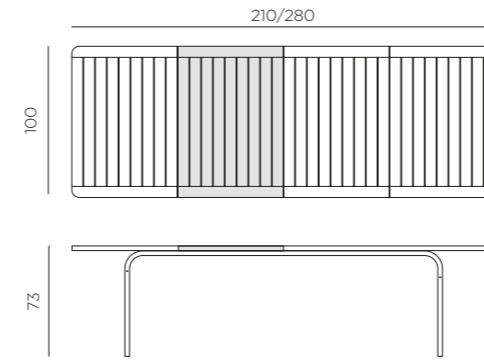

44,5 kg
n. pz. 1



BIANCO
verniciato bianco
42853.00.000



TORTORA
verniciato bianco
42853.10.000

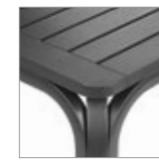

ANTRACITE *
verniciato antracite
42852.02.000



TORTORA
verniciato tortora
42859.10.000

ALLORO 140 EXTENSIBLE 6/8

durelTOP / polypropylene / aluminium

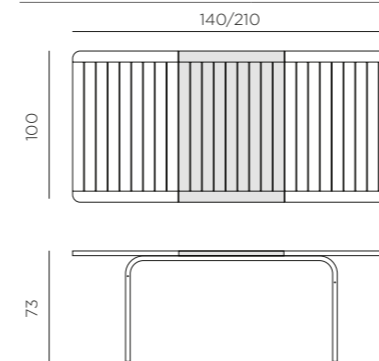

33,7 kg
n. pz. 1



BIANCO
verniciato bianco
42753.00.000



TORTORA
verniciato bianco
42753.10.000



ANTRACITE *
verniciato antracite
42752.02.000



TORTORA
verniciato tortora
42759.10.000

* Posizionare in zone d'ombra - Position in shaded areas - Placer dans des zones ombragées - In schattigen Bereichen aufstellen - Colocar en zonas de sombra - Posicionar em zonas de sombra - Gölgeci alanlara yerleştiriniz - Размещать в тени

CUBE 140X80

durelTOP / polypropylene / aluminium

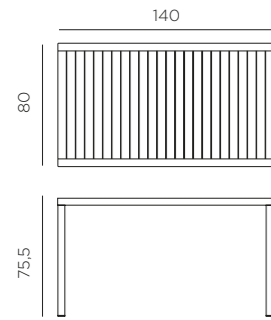

16,9 kg
n. pz. 1



BIANCO
verniciato bianco
47753.00.000

ANTRACITE *
verniciato antracite
47752.02.000

TORTORA
verniciato tortora
47759.10.000

new
TABACCO *
verniciato tabacco
47767.53.000

CUBE 120X70

durelTOP / polypropylene / aluminium

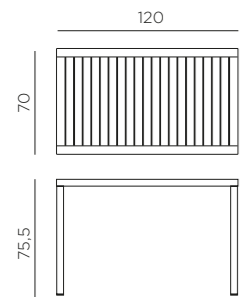

13,5 kg
n. pz. 1



BIANCO
verniciato bianco
47653.00.000

ANTRACITE *
verniciato antracite
47652.02.000

TORTORA
verniciato tortora
47659.10.000

new
TABACCO *
verniciato tabacco
47667.53.000

CUBE 80

durelTOP / polypropylene / aluminium

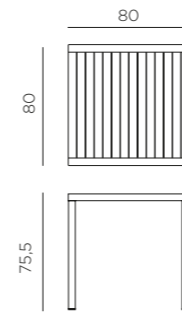

11,5 kg
n. pz. 1



BIANCO
verniciato bianco
48053.00.000

ANTRACITE
verniciato antracite
48052.02.000

TORTORA
verniciato tortora
48059.10.000

new
TABACCO
verniciato tabacco
48067.53.000

CUBE 70

durelTOP / polypropylene / aluminium

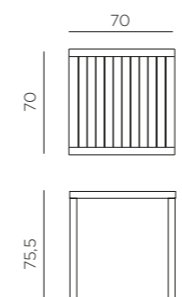

9,5 kg
n. pz. 1



BIANCO
verniciato bianco
47853.00.000

ANTRACITE
verniciato antracite
47852.02.000

TORTORA
verniciato tortora
47859.10.000

new
TABACCO
verniciato tabacco
47867.53.000

* Posizionare in zone d'ombra - Position in shaded areas - Placer dans des zones ombragées - In schattigen Bereichen aufstellen - Colocar en zonas de sombra - Posicionar em zonas de sombra - Gölgeyi alanlara yerleştiriniz - Размещать в тени

DOGA TABLE

polypropylene fiberglass

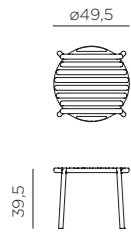

2,9 kg
n. pz. 4



BIANCO
40042.00.000



ANTRACITE
40042.02.000



CAPPUCCINO
40042.14.000



MENTA
40042.15.000



AGAVE
40042.16.000



PERA
40042.18.000



MARSALA
40042.21.000



TABACCO
40042.53.000

NET TABLE 100

polypropylene fiberglass

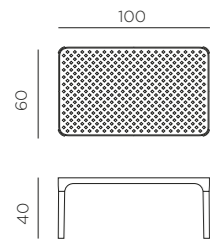

6,3 kg
n. pz. 1



BIANCO
40064.00.000



ANTRACITE
40064.02.000



SALICE
40064.04.000



TORTORA
40064.10.000



SENAPE
40064.56.000



CORALLO
40064.75.000

SPRITZ

polypropylene fiberglass

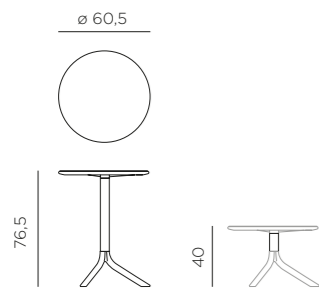

4,3 kg
n. pz. 1



BIANCO
40058.00.000



ANTRACITE
40058.02.000



ROSSO
40058.07.000



TORTORA
40058.10.000



AGAVE
40058.16.000



CELESTE
40058.39.000

ARIA TAVOLINO 100

polypropylene

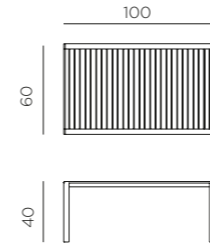

8 kg
n. pz. 1



BIANCO
40052.00.000



TORTORA
40052.10.000

ARIA TAVOLINO 60

polypropylene

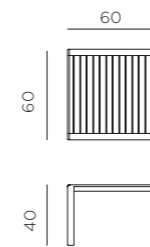

4,5 kg
n. pz. 1



BIANCO
40051.00.000



TORTORA
40051.10.000

POP

polypropylene fiberglass

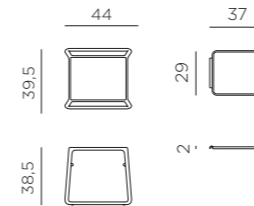

2,5 kg
n. pz. 4



BIANCO
40048.00.000



ANTRACITE
40048.02.000



TORTORA
40048.10.000

regeneration

Il nostro impegno nel realizzare prodotti dall'alto valore aggiunto e sostenibili per l'ambiente ci ha portati a inaugurare nel 2019 il programma industriale Regeneration per la produzione di arredi per esterno in plastica riciclata.

Li facciamo in uno stabilimento progettato con tecnologie all'avanguardia a livello impiantistico, dotato di presse a iniezione ibride ad alto risparmio energetico nelle quali il sistema di raffreddamento utilizza l'aria senza impiegare acqua e consumando pochissima energia elettrica. Quest'ultima è generata, in gran parte, da un sistema di pannelli fotovoltaici.

Regeneration è molto più di una semplice linea di prodotti in plastica riciclata e ci permette di sperimentare soluzioni applicabili su larga scala a tutto il ciclo produttivo coinvolgendo tutte le fasi, dall'ideazione dei singoli arredi fino al loro imballaggio.

Per quest'ultimo aspetto per la linea Regeneration tutti gli imballi di protezione e i relativi sostegni interni sono in cartone riciclato certificato FSC e polietilene a bassa densità completamente riciclabile, entrambi progettati in modo da ridurre al minimo il loro impiego.

Infine, ci impegniamo ogni giorno a mettere progressivamente in atto azioni per migliorare le nostre performance ambientali grazie alle analisi LCA (Life Cycle Assessment), metodologia analitica e sistematica che valuta l'impronta ambientale dei nostri nuovi prodotti lungo il loro intero ciclo di vita.

Per maggiori informazioni visita
www.nardioutdoor.com/regeneration

Our commitment to making environmentally sustainable products with high added value led us to launch the Regeneration industrial programme, in 2019, for the production of outdoor furniture in recycled plastic.

We make our products at a production plant designed with cutting-edge plant engineering technology. It is equipped with energy-saving hybrid injection presses, with an air-based cooling system without using water and consuming very little electricity. Most of the electricity used is produced by a photovoltaic panel system.

Regeneration is much more than a simple line of recycled plastic products. It allows us to experiment with solutions that can be applied on a large scale to the entire production cycle and involves all steps, from the concept creation of individual furniture items to their packaging.

For more information visit
www.nardioutdoor.com/regeneration



For the Regeneration line, all protective packaging and related internal supports are made of FSC-certified recycled cardboard and fully recyclable low-density polyethylene, both designed to minimise their use.

Lastly, every day we strive to gradually implement actions to improve our environmental performance by means of LCA (Life Cycle Assessment) analysis, an analytical and systematic methodology that assesses the environmental footprint of our new products throughout their entire life cycle.

SIPARIO

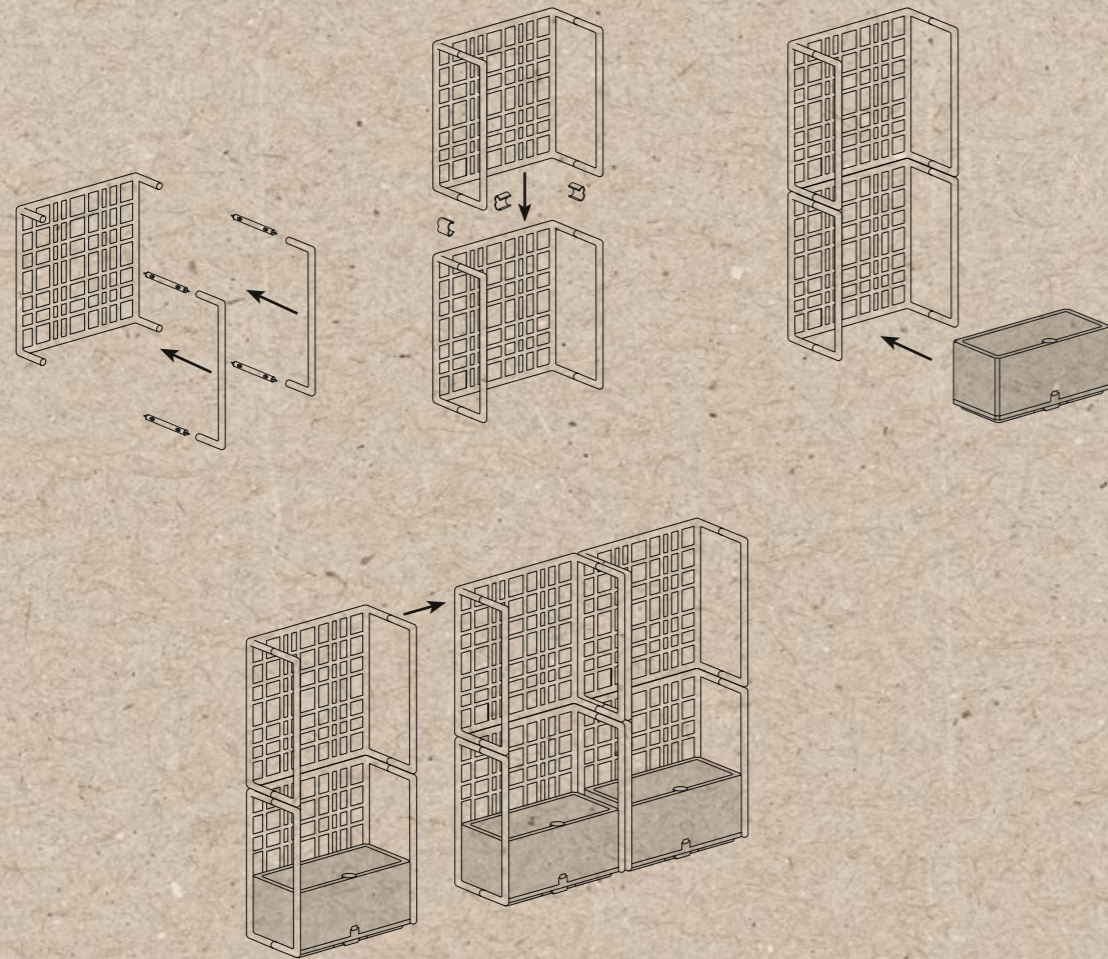

SIPARIO è un divisorio modulare autoportante da esterno configurabile a piacere, ideale per dividere gli spazi aperti. È costituito da elementi grigliati facilmente agganciabili tra loro senza l'uso di viti e dotato di vaso contenitore per piante. È realizzato in plastica rigenerata

SIPARIO, a free-standing modular partition for outdoor use, can be configured as required and is ideal for separating open spaces. It consists of grid elements, easily hooked together without using screws, and includes a container for plants. It's made of regenerated plastic

regeneration

SIPARIO 3

regenerated polypropylene fiberglass

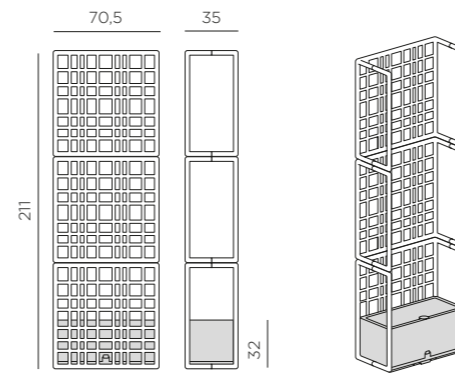

19,1 kg
n. pz. 1



TERRA
40395.44.000

new



GESSO
40395.29.000

new



CACTUS
40395.27.000

new

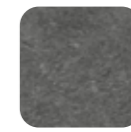

BASALTO
40395.25.000

SIPARIO 2

regenerated polypropylene fiberglass

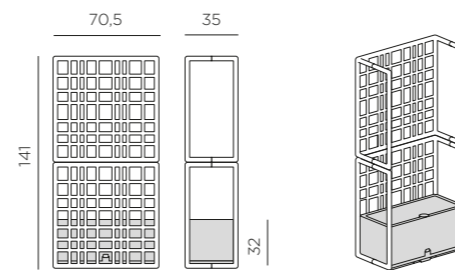

14,6 kg
n. pz. 1



TERRA
40394.44.000

new

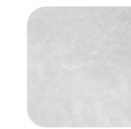

GESSO
40394.29.000

new



CACTUS
40394.27.000

new

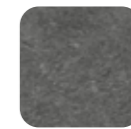

BASALTO
40394.25.000

SIPARIO MODULO

regenerated polypropylene fiberglass

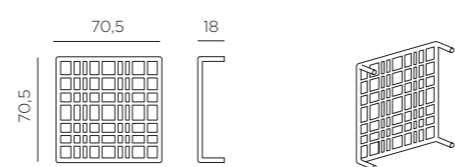

3,3 kg
n. pz. 1



TERRA
40381.44.000

new

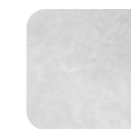

GESSO
40381.29.000

new



CACTUS
40381.27.000

new



BASALTO
40381.25.000

Life Cycle Assessment

For more information visit www.nardioutdoor.com/sustainability

Il polipropilene fiberglass rigenerato può subire delle variazioni di colore dovute all'utilizzo di materiale riciclato - Regenerated fiberglass polypropylene may undergo variations in color due to the use of recycled material - Polypropylène fiberglass régénérée peut subir variations de couleur en raison de l'utilisation de matériaux recyclés - Regeneriertem fiberglass-Polypropylen kann aufgrund der Verwendung von recyceltem Material Farbabweichungen unterliegen - El polipropileno fiberglass regenerado puede sufrir variaciones de color debido al uso de material reciclado - O polipropileno fiberglass regenerado pode sofrer variações de cor devido ao uso de material reciclado - Rejenere edilmiş polipropilen fiberglass, geri dönüşüm malzemesi kullanımı nedeniyle renk değişikliğine maruz kalabilir - Цвет регенерированного полипропиленового стекловолокна может претерпевать изменения вследствие использования переработанного материала.

SIPARIO VASO

regenerated polypropylene fiberglass

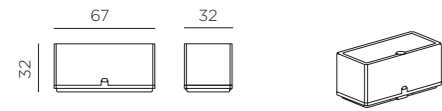

6,4 kg
n. pz. 1



TERRA
40382.44.000

new



GESSO
40382.29.000

new

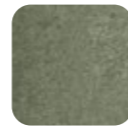

CACTUS
40382.27.000

new

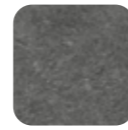

BASALTO
40382.25.000

SIPARIO CHIUSURA

regenerated polypropylene fiberglass

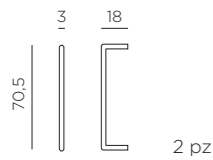

1 kg
n. pz. 1 1 KIT = 2 pz



TERRA
40383.44.000

new



GESSO
40383.29.000

new

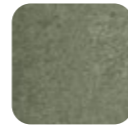

CACTUS
40383.27.000

new

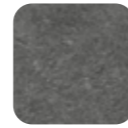

BASALTO
40383.25.000

SIPARIO KIT CLIPS

regenerated polypropylene fiberglass



0,4 kg
n. pz. 1 1 KIT = 4+6 pz



TERRA
40392.44.000

new



GESSO
40392.29.000

new

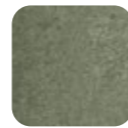

CACTUS
40392.27.000

new

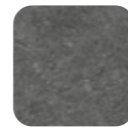

BASALTO
40392.25.000

accessories

Il polipropilene fiberglass rigenerato può subire delle variazioni di colore dovute all'utilizzo di materiale riciclato - Regenerated fiberglass polypropylene may undergo variations in color due to the use of recycled material - Polypropylène fiberglass régénérée peut subir variations de couleur en raison de l'utilisation de matériaux recyclés - Regeneriertem fiberglass-Polypropylen kann aufgrund der Verwendung von recyceltem Material Farbabweichungen unterliegen - El polipropileno fiberglass regenerado puede sufrir variaciones de color debido al uso de material reciclado - O polipropileno fiberglass regenerado pode sofrer variações de cor devido ao uso de material reciclado - Rejenere edilmiş polipropilen fiberglass, geri dönüşüm malzemesi kullanımı nedeniyle renk değişikliklerine maruz kalabilir - Цвет регенерированного полипропиленового стекловолокна может претерпевать изменения вследствие использования переработанного материала.

CUSCINO NET BENCH

fabric

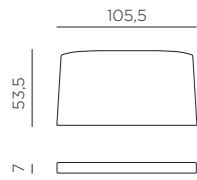

1,5 kg
n. pz. 4

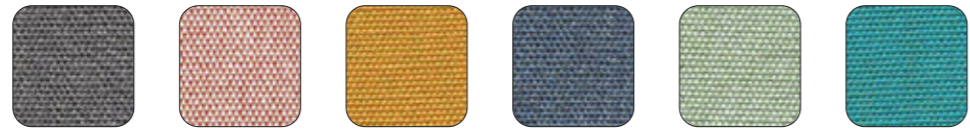

grey stone # 36338.00.064
rosa quarzo # 36338.00.066
senape # 36338.00.069
denim # 36338.00.070
the verde # 36338.00.071
sardinia # 36338.00.072



bianco 36338.00.155
grigio # 36338.00.163
grigio Sunbrella® * 36338.00.136

CUSCINO NET RELAX

fabric

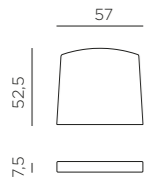

0,8 kg
n. pz. 4

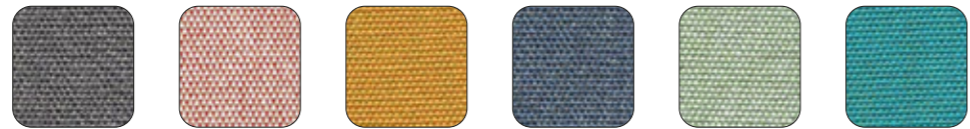

grey stone # 36327.00.064
rosa quarzo # 36327.00.066
senape # 36327.00.069
denim # 36327.00.070
the verde # 36327.00.071
sardinia # 36327.00.072



bianco 36327.00.155
grigio # 36327.00.163
grigio Sunbrella® * 36327.00.136

CUSCINO NET

fabric

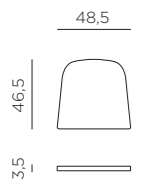

0,3 kg
n. pz. 4

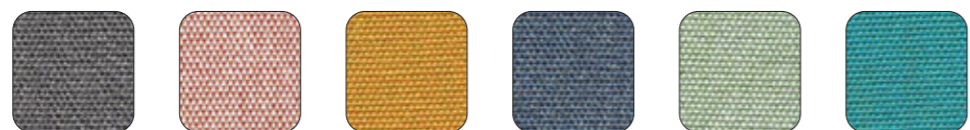

grey stone # 36326.00.064
rosa quarzo # 36326.00.066
senape # 36326.00.069
denim # 36326.00.070
the verde # 36326.00.071
sardinia # 36326.00.072



bianco 36326.00.155
grigio # 36326.00.163
grigio Sunbrella® * 36326.00.136

CUSCINO SHELL (NET RELAX)

fabric

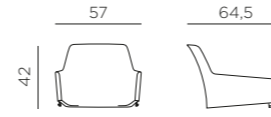

2,2 kg
n. pz. 2



rosa quarzo # 36327.01.066
denim # 36327.01.070
grigio # 36327.01.163

Utilizzabile solo con cuscino Net Relax - Can only be used with Net Relax cushion - À utiliser uniquement avec le coussin Net Relax - Kann nur mit Net Relax Kissen verwendet werden - Se puede utilizar sólo con el cojín Net Relax - Só pode ser usada em conjunto com almofada de assento Net Relax - Sadece Net Relax minderiyle kullanılmali - Можно использовать только с подушкой Net Relax.

CUSCINO BIT

fabric



0,3 kg
n. pz. 4



grigio # 36328.00.163

CUSCINO POGGIATESTA NET LOUNGE **new**

fabric

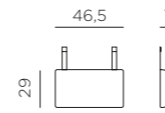

0,3 kg
n. pz. 4



rosa quarzo # 36329.04.066
senape # 36329.04.069
grigio Sunbrella® 36329.04.136

TELO MARE NET LOUNGE **new**

fabric



0,43 kg
n. pz. 12



bianco 149329.60.050
senape 149329.65.650
corallo 149329.67.550

Variazioni di colore sono da ritenersi standard e naturali nei tessuti acrilici tinto filo. Posizionare in zone d'ombra - Colour variations are to be considered standard and natural in yarn-dyed acrylic fabrics. Position in shaded areas - Les variations de couleur des tissus acryliques au fil teint sont standard et naturelles. Placer dans des zones ombragées - Farbveränderungen sind als Standard und in im Garn gefärbten Acrylgeweben als natürlich zu betrachten. In schattigen Bereichen aufstellen - Las variaciones de color son normales y naturales en las telas acrílicas teñidas en hilo. Colocar en zonas de sombra - As variações de cor são consideradas standard e naturais nos tecidos acrílico tingidos com fio. Posicionar em zonas de sombra - Boyalı akrilik iplik kumaşlarda renk değişiklikleri standart ve doğal kabul edilir. Gölgeli alanlara yerleştiriniz - Изменения цвета следует считать нормой, они являются естественными в случае акриловых тканей с окрашенными волокнами. Размещать в тени

* Trattamento laminato su richiesta con quantità minima - Laminated finish available on request with a minimum quantity - Traitement laminé sur demande avec une quantité minimum - Laminierte Ausrüstung auf Anfrage mit einer Mindestmenge - Tratamiento laminado bajo pedido con una cantidad mínima - Tratamento laminado sob encomenda com quantidade mínima - Talep üzerine minimum miktarda lamine işlem - Ламинированная обработка по запросу с минимальным количеством

CUSCINO DOGA RELAX

fabric

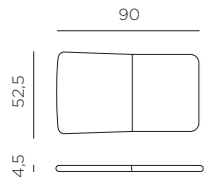

0,7 kg
n. pz. 4



CUSCINO DOGA ARMCHAIR

fabric

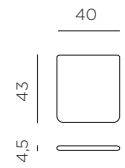

0,3 kg
n. pz. 4



CUSCINO DOGA BISTROT

fabric

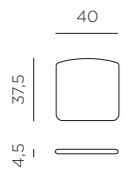

0,25 kg
n. pz. 4



CUSCINO TRILL

fabric

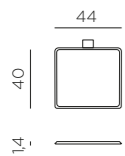

0,2 kg
n. pz. 4



grafite
36253.00.130

Solo per sedia Trill Bistrot - Only for Trill Bistrot chair -
Seulement pour la chaise Trill Bistrot - Nur für Trill Bistrot
Stuhl - Sólo para silla Trill Bistrot - Apenas para cadeira
Trill Bistrot - Sadece Trill Bistrot sandalyesi için - Только для
кресла Trill Bistrot.

CUSCINO PASSEPARTOUT

fabric

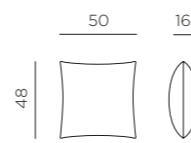

0,7 kg
n. pz. 4



CUSCINO RETTANGOLARE

fabric

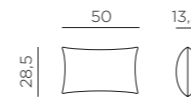

0,55 kg
n. pz. 4

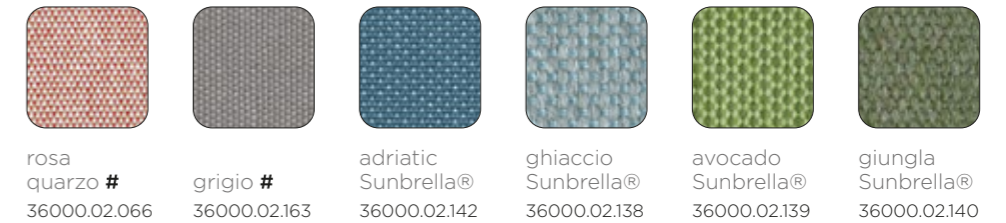

Variazioni di colore sono da ritenersi standard e naturali nei tessuti acrilici tinto filo. Posizionare in zone d'ombra - Colour variations are to be considered standard and natural in yarn-dyed acrylic fabrics. Position in shaded areas - Les variations de couleur des tissus acryliques au fil teint sont standard et naturelles. Placer dans des zones ombragées - Farbveränderungen sind als Standard und in im Garn gefärbten Acrylgeweben als natürlich zu betrachten. In schattigen Bereichen aufstellen - Las variaciones de color son normales y naturales en las telas acrílicas teñidas en hilo. Colocar en zonas de sombra - As variações de cor são consideradas standard e naturais nos tecidos acrílico tingidos com fio. Posicionar em zonas de sombra - Boyalı akrilik iplik kumaşlarda renk değişiklikleri standart ve doğal kabul edilir. Gölgeli alanlara yerleştiriniz - Изменения цвета следует считать нормой, они являются естественными в случае акриловых тканей с окрашенными волокнами. Размещать в тени

COVER SMALL

(4/6 CHAIRS / 1 ELEMENT SOFA)

fabric

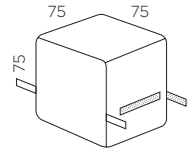

0,7 kg
n. pz. 25



smoke
37000.01.204

COVER MEDIUM

(2/4 SUNLOUNGERS)

fabric

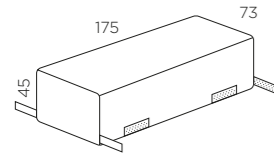

0,8 kg
n. pz. 20



smoke
37000.02.204

COVER LARGE

(2 ELEMENT SOFA / TABLE 140)

fabric

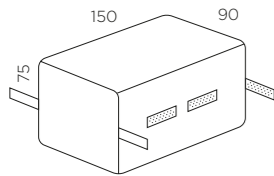

1,1 kg
n. pz. 20



smoke
37000.03.204

COVER EXTRALARGE

(3 ELEMENT SOFA / TABLE 210)

fabric

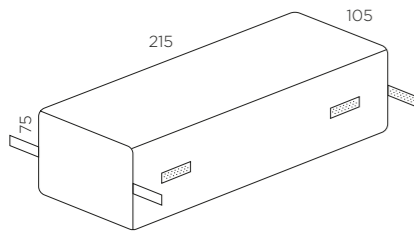

1,6 kg
n. pz. 15



smoke
37000.04.204

materials

polypropylene

Polipropilene trattato anti-UV e colorato in massa. Riciclabile al 100% - Polypropylene with UV additives and is uniformly colored. 100% Recyclable resin - Polypropylène traité anti-UV et coloré dans la masse. Résine recyclable 100% - UV-beständigem Polypropylen, voll durchgefärbt. 100% Recyclebarer Kunststoff - Polipropileno tratado anti-UV y teñido en masa. Resina reciclable 100% - Polipropileno com tratamento anti-UV colorido na totalidade. Resina reciclável 100% - Işığa dayanıklı ve boyalı olarak granül çekilmiş %100 geri dönüşümlü polipropilen kompozit hammadde - Полипропилен с обработкой анти-УФ, окрашенное в массе. На 100% пригодно для вторичной переработки.

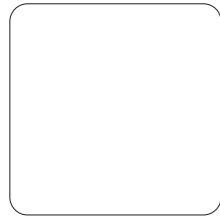

BIANCO .00



GRIGIO .03



ANTRACITE .02



CORDA .24



TORTORA .10



TABACCO .53



CELESTE .39



OTTANIO .49



SALICE .04



MENTA .15



AGAVE .16



PERA .18



CAPPUCCINO .14



SENAPE .56

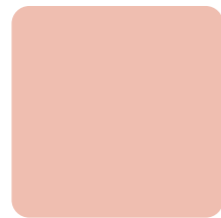

ROSA BOUQUET .08

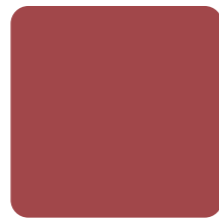

MARSALA .21



CORALLO .75



ROSSO .07

fiberglass polypropylene

Polipropilene fiberglass trattato anti-UV e colorato in massa. Resina riciclabile al 100% - Uniformly colored fiberglass polypropylene resins with UV additives. 100% Recyclable resin - Polypropylène fiberglass traité anti-UV et coloré dans la masse. Résine recyclable 100% - UV-beständigem fiberglass Polypropylen, voll durchgefärbt. 100% Recyclebarer Kunststoff - Polipropileno fiberglass tratado anti-UV y teñido en masa. Resina reciclable 100% - Polipropileno fiberglass com tratamento anti-UV colorido na totalidade. Resina reciclável 100% - Işığa dayanıklı ve boyalı olarak granül çekilmiş %100 geri dönüşümlü cam elyaf katkılı polipropilen kompozit hammadde - Полипропилен фиброволокно с обработкой анти-УФ, окрашенное в массе. На 100% пригодно для вторичной переработки.

regenerated fiberglass polypropylene

Polipropilene fiberglass rigenerato trattato anti-UV e colorato in massa. Resina riciclabile al 100% - Regenerated uniformly colored fiberglass polypropylene resins with UV additives. 100% Recyclable resin - Polypropylène fiberglass régénérée traité anti-UV et coloré dans la masse. Résine recyclable 100% - Regeneriertem UV-beständigem fiberglass-Polypropylen, voll durchgefärbt. 100% Recyclebarer Kunststoff - Polipropileno fiberglass regenerado tratado

anti-UV y teñido en masa. Resina reciclable 100% - Polipropileno fiberglass regenerado com tratamento anti-UV colorido na totalidade. Resina reciclável 100% - UV katlı maddeleriyle fiberglass polipropilen reçine ile renklendirilip düzgün bir şekilde tekrar oluşturulmuştur - Переработанный, крашеный, полипропилен fiberglass обработанный против проникновения ультрафиолетовых лучей. На 100% пригодно для вторичной переработки.



TERRA .44



GESSO .29

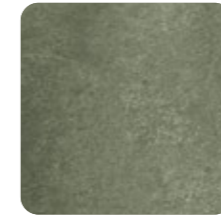

CACTUS .27

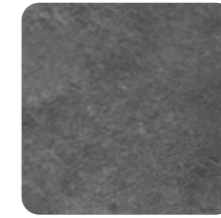

BASALTO .25

Il polipropilene fiberglass rigenerato può subire delle variazioni di colore dovute all'utilizzo di materiale riciclato. - Regenerated fiberglass polypropylene may undergo variations in color due to the use of recycled material. - Polypropylène fiberglass régénérée peut subir variations de couleur en raison de l'utilisation de matériaux recyclés. - Regeneriertem fiberglass-Polypropylen kann aufgrund der Verwendung von recyceltem Material Farbabweichungen unterliegen. - El polipropileno fiberglass regenerado puede sufrir variaciones de color

debido al uso de material reciclado. - O polipropileno fiberglass regenerado pode sofrer variações de cor devido ao uso de material reciclado. - Rejenere edilmiş polipropilen fiberglass, geri dönüşüm malzemesi kullanımı nedeniyle renk değişikliklerine maruz kalabilir. - Цвет регенерированного полипропиленового стекловолокна может претерпевать изменения вследствие использования переработанного материала.

acrylic fabric

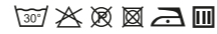

Fibra acrilica 100% tinto filo. Trattamento antimacchia, antimuffa. Solidità alla luce 5/8. Lavabile a 30° - 100% yarn dyed acrylic. Dirt repellent and anti-mould treatment. 5/8 light fastness. Washable at 30° - 100% fibre acrylique teintée en fils. Traitement anti-taches et anti-moisissure. Résistance à la lumière 5/8. Lavable à 30° - 100% garngefärbtes Polyacryl Gewebe. Gegen Flecken und Schimmel Ausrüstung. Lichtechtheit 5/8. Waschbar bei 30° - 100% hilo teñido

acrílico. Protección antimanchas, antimoho. Solidez a la luz 5/8. Lavable a 30° - 100% fibra acrílica tingida com fio. Tratamento antimancha e antimoho. Resistência à luz 5/8. Lavável a 30° - %100 akrilik elyaf boyalı iplik. Leke itici, küf önleyici ile muamele edilmiş. Işık haslığı 5/8. 30°de yıkanabilir - Акриловое волокно 100% окрашенное в пряже. Пятноустойчивая и противоглесневая обработка. Светостойкость 5/8. Стирать при 30°.

Variazioni di colore sono da ritenersi standard e naturali nei tessuti acrilici tinto filo. Posizionare in zone d'ombra - Colour variations are to be considered standard and natural in yarn-dyed acrylic fabrics. Position in shaded areas - Les variations de couleur des tissus acryliques au fil teint sont standard et naturelles. Placer dans des zones ombragées - Farbveränderungen sind als Standard und in im Garn gefärbten Acrylgeweben als natürlich zu betrachten. In schattigen Bereichen aufstellen - Las variaciones de color son normales y naturales en las telas acrílicas teñidas en hilo. Colocar en zonas de sombra - As variações de cor são consideradas standard e naturais nos tecidos acrílico tingidos com fio. Posicionar em zonas de sombra - Boyalı akrilik iplik kumaşlarda renk değişiklikleri standart ve doğal kabul edilir. Gölge alanlara yerleştiriniz - Изменения цвета следует считать нормой, они являются естественными в случае акриловых тканей с окрашенными волокнами. Размещать в тени.

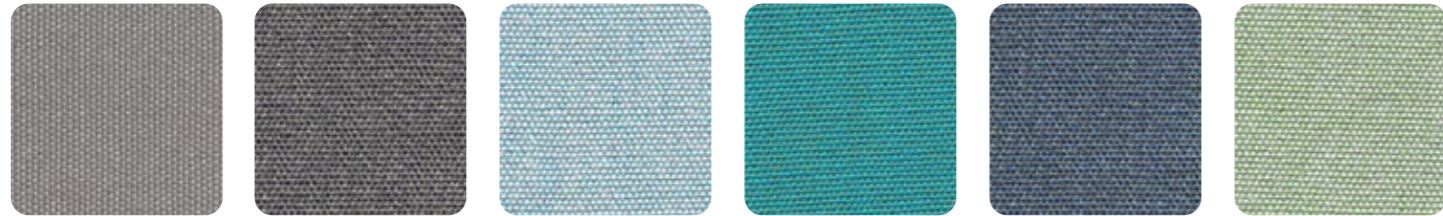

grigio .163
240 gr/m²

grey stone .064
240 gr/m²

artic .161
240 gr/m²

sardinia .072
240 gr/m²

denim .070
240 gr/m²

the verde .071
240 gr/m²

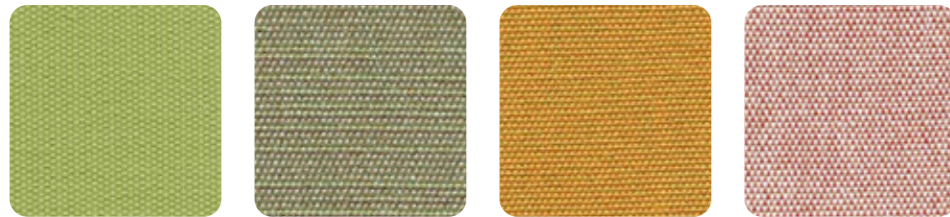

lime .061
240 gr/m²

felce .162
240 gr/m²

senape .069
240 gr/m²

rosa quarzo .066
240 gr/m²

acrylic fabric with digital print



Fibra acrilica 100% stampa digitale. Solidità alla luce 6. Lavabile a 30° - 100% acrylic fiber with digital print. 6 light fastness. Washable at 30° - 100% fibre acrylique impression numérique. Résistance à la lumière 6. Lavable à 30° - 100% Polyacrylfaser mit Digitaldruck. Lichtechtheit 6. Waschbar bei 30° - 100%

fibra acrílica impresión digital. Solidez a la luz 6. Lavable a 30° - 100% fibra acrílica estampa digital. Resistência à luz 6. Lavável a 30° - %100 dijital baskı akrilik elyaf. Işık haslığı 6. 30°de yıkanabilir - 100% акриловое волокно с цифровым рисунком, окрашенное в процессе производства. Светостойкость 6. Стирка при 30°.



tropical .081
190 gr/m²

Sunbrella® acrylic fabric



100% fibra acrilica Sunbrella® tinto in massa. Trattamento idrorepellente, antimacchia, antimuffa. Solidità alla luce 8/8. Lavabile a 30° - 100% Sunbrella® acrylic fiber mass dyed. Water repellent treatment, dirt repellent and anti-mould treatment. 8/8 light fastness. Washable at 30° - 100% fibre acrylique Sunbrella® teintée en masse. Traitement imperméable, anti-taches et anti-moisissure. Résistance à la lumière 8/8. Lavable à 30° - 100% fasergefärbtes Sunbrella® Polyacryl. Wasserabweisend Ausrüstung, gegen Flecken und Schimmel ausgerüstet. Lichtechtheit 8/8. Waschbar bei 30° - 100% fibra acrílica

Sunbrella® tintada en masa. Tratamiento por la repelencia al agua, protección antimanchas, antimoho. Solidez a la luz 8/8. Lavable a 30° - 100% fibra acrílica Sunbrella® tingida em massa. Tratamento hidrorrepelente, antimancha e antimoho. Resistência à luz 8/8. Lavável a 30° - %100 akrilik elyaf Sunbrella® çözelti halinde boyanmış. Su itici, leke itici, küf önleyici ile muamele edilmiş. Işık haslığı 8/8. 30°de yıkanabilir - 100% акриловое волокно Sunbrella®, окрашенное в массе. Водоотталкивающая, пятноустойчивая и противоглесневая обработка. Светостойкость 8/8. Стирать при 30°.

* 50% fibra acrilica Sunbrella® riciclata tinto in massa, 47% fibra acrilica Sunbrella® tinto in massa, 3% poliester - 50% recycled Sunbrella® acrylic fiber mass dyed, 47% Sunbrella® acrylic fiber mass dyed, 3% polyester - 50% fibre acrylique Sunbrella® recyclée teintée en masse, 47% fibre acrylique Sunbrella® teintée en masse, 3% de polyeste - 50% fasergefärbtes, recyceltes Sunbrella® Polyacryl, 47% fasergefärbtes Sunbrella® Polyacryl, 3% Polyester - 50% fibra acrílica Sunbrella® reciclada tintada en masa, 47% fibra acrílica Sunbrella® tintada en masa, 3% poliéster - 50% geri dönüştürülmüş akrilik elyaf Sunbrella® çözelti halinde boyanmış, %47 akrilik elyaf Sunbrella® çözelti halinde boyanmış, % 3 polyester - 50% переработанное акриловое волокно Sunbrella®, окрашенное в массе, 47% акриловое волокно Sunbrella®, окрашенное в массе, 3% полиэстер.



grigio Sunbrella® .136
275 gr/m²

canvas Sunbrella® .141
275 gr/m²

fumo Sunbrella® .193
275 gr/m²

ghiaccio Sunbrella® .138
275 gr/m²

adriatic Sunbrella® .142
260 gr/m²

avocado Sunbrella® .139
260 gr/m²

giungla Sunbrella® .140 *
340 gr/m²

opera Sunbrella® .187
260 gr/m²

Sunbrella® EXTRA



Tessuti disponibili su ordinazione per minimi quantitativi d'ordine solo per il prodotto KOMODO - Fabrics available to order for minimum order quantities for the KOMODO product only - Tissus disponibles sur commande de quantités minimales pour le produit KOMODO uniquement - Gewebe auf Bestellung für Mindestbestellmengen nur für das Produkt KOMODO erhältlich

- Telas disponibles bajo pedido para cantidades mínimas solo para el producto KOMODO - Tecidos disponíveis por encomenda para quantidades mínimas de encomenda apenas para o produto KOMODO - Sadece KOMODO ürünü için minimum sipariş miktarına göre sipariş verilebilecek kumaşlar - ткани на заказ для минимального объема заказа только для изделия KOMODO.



marble Sunbrella® .186
260 gr/m²

blue storm Sunbrella® .185
260 gr/m²

alpine Sunbrella® .182
260 gr/m²

mink brown Sunbrella® .183
260 gr/m²

pumpkin Sunbrella® .184
260 gr/m²

laminated treatment

(Su richiesta - On request - Sur demande - Auf Anfrage - Bajo pedido - Sob encomenda - İstek üzerine - По запросу)



Il tessuto è accoppiato internamente con un film in poliuretano che lo rende impermeabile. La parte accoppiata in poliuretano non deve essere esposta al sole. Applicabile su richiesta con quantità minima su tessuti acrilici Sunbrella® - The fabric is bonded with a polyurethane film that makes it waterproof. The polyurethane laminated surface should not be exposed to direct sunlight. Applicable on Sunbrella® acrylic fabrics on request with a minimum quantity - Le tissu est doublé en interne avec un film de polyuréthane qui le rend imperméable. La partie en polyuréthane ne doit pas être exposée au soleil. Applicable sur demande avec une quantité minimale sur les tissus acryliques Sunbrella® - Das Gewebe ist innen mit einer Polyurethanfolie verbunden, die es wasserdicht macht. Das mit Polyurethan verbundene Teil darf nicht der Sonne ausgesetzt werden. Auf Anfrage mit Mindestmenge auf Sunbrella® Polyacryl Gewebe anwendbar - El tejido

está acoplado internamente con una película de poliuretano que lo hace impermeable. La parte acoplada de poliuretano no debe exponerse al sol. Aplicable bajo pedido con una cantidad mínima en tejidos acrílicos Sunbrella® - O tecido é dublado com filme interno de poliuretano que o torna impermeável. O lado que possui o filme de poliuretano não pode ser exposta ao sol. Aplicável sob encomenda, com quantidade mínima, em tecidos acrílicos Sunbrella® - Kumaş, su geçirmez hale getiren bir poliüretan film ile dahili olarak birleştirilmiştir. Birleştirilmiş poliüretan bölümler güneşe maruz bırakılmamalıdır. Sunbrella® akrilik kumaşlar üzerine minimum miktarda istek üzerine uygulanabilir - Ткань внутренне соединена с полиуретановой пленкой, которая делает ее водонепроницаемой. та часть ,где имеется добавка полиуритана не выставлять на солнце. Применяется по запросу с минимальным количеством на акриловых тканях Sunbrella®.

mass dyed acrylic fabric

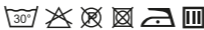

100% fibra acrílica tinto in massa. Trattamento idrorepellente, antimacchia, antimuffa. Solidità alla luce 7/8. Lavabile a 30° - 100% acrylic fiber mass dyed. Water repellent treatment, dirt repellent and anti-mould treatment. 7/8 light fastness. Washable at 30° - 100% fibre acrylique teintée en masse. Traitement imperméable, anti-taches et anti-moisissure. Résistance à la lumière 7/8. Lavable à 30° - 100% fasergefärbtes Polyacryl. Wasserabweisend Ausrüstung, gegen Flecken und Schimmel ausgerüstet. Lichtechtheit 7/8. Waschbar bei

30° - 100% fibra acrílica tintada en masa. Tratamiento hidropelente, protección antimanchas, antimoho. Solidez a la luz 7/8. Lavable a 30° - 100% fibra acrílica tingida em massa. Tratamento hidrorepelente, antimancha e antimoho. Resistência à luz 7/8. Lavável a 30° - %100 akrilik elyaf çözültü halindeyken boyanmış. Su itici, leke itici, küf önleyici ile muamele edilmiş. Işık haslıđı 7/8. 30°de yıkanabilir - 100% акриловое волокно окрашенное в массе. Водоотталкивающая, пятноустойчивая и противогрибковая обработка. Светостойкость 7/8. Стирать при 30°.



lino .152
280 gr/m²

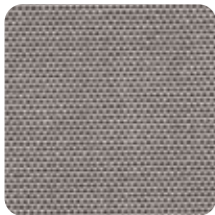

grigio Komodo .172
240 gr/m²

mass dyed acrylic fabric for Komodo Ombra



100% fibra acrílica tinto in massa. Trattamento idrorepellente, antimacchia, antimuffa. Solidità alla luce 7-8/8. Lavabile a 30°. Il tessuto Velo deve essere impiegato solo come telo-parasole. La maglia larga permette l'areazione e allo stesso tempo crea una zona d'ombra sottostante ma non trattiene l'acqua - 100% acrylic fiber mass dyed. Water repellent treatment, dirt repellent and anti-mould treatment. 7-8/8 light fastness. Washable at 30°. Velo fabric should only be used for sunshades. Its wide mesh allows ventilation while creating a shaded area below, but it does not retain water - 100% fibre acrylique teintée en masse. Traitement imperméable, anti-taches et anti-moisissure. Résistance à la lumière 7-8/8. Lavable à 30°. Le tissu Velo ne doit être utilisé que comme toile de parasol. Les mailles larges permettant de s'aérer tout en créant, en même temps, une zone d'ombre en dessous. Velo n'est pas imperméable - 100% fasergefärbtes Polyacryl. Wasserabweisend Ausrüstung, gegen Flecken und Schimmel ausgerüstet. Lichtechtheit 7-8/8. Waschbar bei 30°. Das Gewebe Velo darf nur als Sonnenschutz Tuch verwendet werden. Die großen Maschen gestatten die Belüftung und gleichzeitig bildet sich darunter ein Schattenbereich, doch es hält Wasser nicht

zurück - 100% fibra acrílica tintada en masa. Tratamiento hidropelente, protección antimanchas, antimoho. Solidez a la luz 7-8/8. Lavable a 30°. La tela Velo debe utilizarse únicamente como parasol, la malla ancha permite la ventilación y crea por debajo una zona de sombra, pero no protege del agua - 100% fibra acrílica tingida em massa. Tratamento hidrorepelente, antimancha e antimoho. Resistência à luz 7-8/8. Lavável a 30°. O tecido Velo deve ser utilizado apenas como pano guarda-sol, a malha larga permite o arejamento e ao mesmo tempo cria uma zona de sombra subjacente, mas não retém a água - %100 akrilik elyaf çözültü halindeyken boyanmış. Su itici, leke itici, küf önleyici ile muamele edilmiş. Işık haslıđı 7-8/8. 30°de yıkanabilir. Velo doküma sadece güneşlik olarak kullanılmalıdır, geniş gözenekler havalandırma sağlar ve aynı zamanda aşağıda bir gölge alanı oluşturur, fakat su tutma özelliđi yoktur - 100% акриловое волокно, окрашенное в массе. Водоотталкивающая, пятноустойчивая и противогрибковая обработка. Светостойкость 7-8/8, стирать при 30°. Ткань Velo предназначена исключительно для использования в качестве тента для защиты от солнца. Переплетение в виде крупной сетки обеспечивает вентиляцию и в то же время создает затенение под собой, но не задерживает влагу.

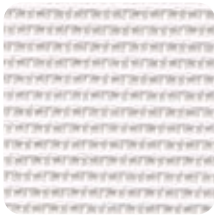

velo white .203
150 gr/m²

TECH



50% vinile e 50% poliestere. Trattamento idrorepellente, antimacchia, antimuffa, ignifugo e antibatterico. Solidità alla luce 6. Lavare a mano in acqua fredda. Alla base dei cuscini seduta comodo TECH panama viene applicata una rete a maglia larga in poliestere per permettere la traspirazione - 50% vinyl and 50% polyester. The treatment makes the coating: water repellent, and resistant to staining, resistant to mold, fire retardant, and antibacterial. 6 light fastness. Hand wash in cold water. At the bottom of the komodo seat cushions, made with TECH panama, the fabric is a polyester wide mesh to allow breathability - 50% vinyle et 50% polyester. Traitement imperméable, anti-taches, anti-moisissures, ignifugé et antibactérien. Résistance à la lumière 6. Laver à la main à l'eau froide. À la base des coussins d'assise comodo TECH panama, un filet de polyester à larges mailles est appliqué pour évacuer la transpiration - 50% Vinyl und 50% Polyester. Wasserabweisend, gegen Flecken und Schimmelbildung ausgerüstet, feuerfest und antibakteriell. Lichtechtheit 6. Handwäsche in kaltem Wasser. Auf der Unterseite der TECH panama Komodo-Sitzkissen ist ein atmungsaktives Polyesternetz mit großer Maschenweite angebracht,

um Luftaustausch zu ermöglichen - 50% vinilo y 50% poliéster. Tratamiento para repeler el agua, ignifugo y antibacteriano, protección antimanchas, antimoho. Solidez a la luz 6. Lavar a mano en agua fría. En la base de los cojines de asiento del komodo TECH panama, se aplica una red de poliéster de malla ancha para permitir la transpiración - 50% de vinil e 50% de poliéster. Tratamiento hidrorepelente, antimancha e antimoho, resistente ao fogo e antibacteriano. Resistência à luz 6. Lavar à mão em água fria. Na base das almofadas do assento de comodo TECH panama, é aplicada uma tela de poliéster de malha larga para permitir a transpiração - % 50 vinil ve % 50 polyester. Su Geçirmez Uygulama,kir tutmaz ve küf önleyici uygulama,yangın geciktirici ve antibakteriyel uygulama. Işık haslıđı 6. Gerektiđinde, el ile sođuk suda yıkanabilir. Hava alması için komodo'nun altındaTECH panama minderle, geniş fileli polyester uygulanmıştır - 50% винил и 50% полиэстер. типы обработки: водоотталкивающая,пятно-отталкивающая,пленкозащитная,невозгораемая и антибактериальная устойчивость к . Светостойкость 6. Ручная стирка в холодной воде. в основе подушек comodo материал Tech panama добавлена сетка с широкой вязкой из полиэстера, чтобы материал проветривался.



TECH panama .131
830 gr/m²

thermoformed Cuscino Trill



100% fibra acrílica tinto in massa. Trattamento idrorepellente, antimacchia, antimuffa. Solidità alla luce 7-8/8. Senza cuciture. Lavabile a 30°. Imbottitura: poliuretano espanso rivestito da una membrana TPU waterproof. Densità 40 kg/m³ - 100% acrylic fiber mass dyed. Water repellent treatment, dirt repellent and anti-mould treatment. 7-8/8 light fastness. Seamless. Washable at 30°. Padding: polyurethane foam with a TPU waterproof membrane coating. Density 40 kg/m³ - 100 % fibre acrylique teintée en masse. Traitement imperméable, anti-taches e anti-moisissure. Résistance à la lumière 7-8/8. Sans couture. Lavable à 30°. Rembourrage: mousse polyuréthane revêtu d'une membrane TPU imperméable. Densité 40 kg/m³ - 100 % fasergefärbtes Polyacryl. Wasserabweisend Ausrüstung, gegen Flecken und Schimmel ausgerüstet. Lichtechtheit 7-8/8. Ohne Nähte. Waschbar bei 30°. Polsterung: Polyurethanschaum mit einer wasserdichten TPU-Membran abgedeckt. Dichte

40 kg/m³ - 100% fibra acrílica tintada en masa. Tratamiento hidropelente, protección antimanchas, antimoho. Solidez a la luz 7-8/8. Sin costuras. Lavable a 30°. Relleno: espuma de poliuretano recubierto con una membrana de TPU impermeable. Densidad 40 kg/m³ - 100% fibra acrílica tingida em massa. Tratamento hidrorepelente, antimancha e antimoho. Resistência à luz 7-8/8. Sem costuras. Lavável a 30°. Enchimento: espuma de poliuretano com cobertura de membrana TPU impermeável. Densidade 40 kg/m³ - %100 akrilik elyaf çözültü halindeyken boyanmış. Su itici, leke itici, küf önleyici ile muamele edilmiş. Işık haslıđı 7-8/8.Dikişsiz. 30°de yıkanabilir. Dolgu malzemesi: TPU waterproof film ile kaplanmış poliüretan köpük. Yoğunluk 40 kg/m³ - 100% акриловое волокно окрашенное в массе. Водоотталкивающая, пятноустойчивая и противогрибковая обработка. Светостойкость 7-8/8. Без швов. Стирать при 30°. Набивка: пенополиуретан с покрытием из водостойкой мембраны ТПУ. Плотность 40 кг/м³.



grafite .130
500 gr/m²

100% Olefin fabric



100% Olefin tinto in massa. Trattamento antimacchia, antimuffa. Solidità alla luce 7/8. Lavabile a 40° - 100% Olefin mass dyed. Dirt repellent and anti-mould treatment. 7/8 light fastness. Washable at 40° - 100% Olefin teintée en masse. Traitement anti-taches et anti-moisissure. Résistance à la lumière 7/8. Lavable à 40° - 100% fasergefärbtes Olefin. Gegen Flecken und Schimmel Ausrüstung. Lichtechtheit 7/8. Waschbar bei 40° - 100% Olefin tintada

en masa. Protecion antimanchas, antimoho. Solidez a la luz 7/8. Lavable a 40° - 100% Olefin tingida em massa. Tratamento antimancha e antimoho. Resistência à luz 7/8. Lavável a 40° - %100 Olefin çözelti halindeyken boyanmış. Leke itici, küf önleyici ile muamele edilmiş. Işık haslığı 7/8. 40°de yıkanabilir - 100% Olefin, окрашенный в массе. Пятноустойчивая и противоплесневая обработка. Светостойкость 7/8. Стирать при 40°.



bianco .155
190 gr/m²

telo mare Net Lounge



100% cotone. Trattamento IDH. Solidità alla luce 4/5. Lavabile a 30°, programma delicati - 100% cotton. IDH treatment. 4/5 light fastness. Washable at 30°C, delicatas programme - 100 % coton. Traitement IDH. Résistance à la lumière 4/5. Lavable à 30°, programme délicat - 100 % Baumwolle. Ausrüstung: Indanthren. Lichtechtheit 4/5. Waschbar bei 30°, Schonprogramm - 100% algodón. Tratamiento IDH. Solidez a la luz 4/5. Lavable a

30°, programa delicado - 100% algodão. Tratamento IDH. Resistência à luz 4/5. Lavável a 30°, programa delicado - 100% pamuk. IDH işlemi. Işık haslığı 4/5. 30°de yıkanabilir, hassas program - 100%. Обработка изофтальевым дигидразидом (IDH). Светостойкость 4/5. Стирать при 30°, программа для деликатных тканей.



bianco .600
550 gr/m²



senape .656
550 gr/m²

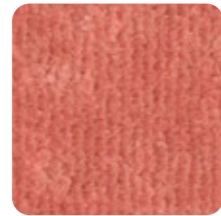

corallo .675
550 gr/m²

synthetic fabric

Tessuto in filo di poliestere rivestito in pvc - Fabric is made of a polyester fiber, with a pvc coating - Tissu en fil de polyester revêtu de pvc - Gewebe aus PVC-ummantelten Polyesterfasern - Tejido en hilo de poliester recubierto

de pvc - Tecido de fibra polyester com cobertura pvc - PVC kaplı polyester elyaf tekstil - Ткань из полиэфирных нитей с покрытием из ПВХ.

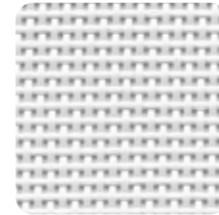

bianco .107
tela 1x1



tortora .104
tela 1x1

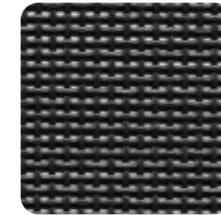

antracite .057
tela 1x1



celeste .075
tela 1x1

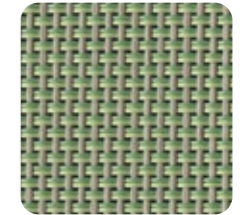

agave .101
tela 2x1

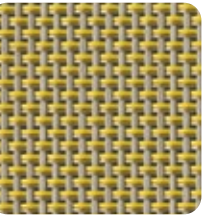

deserto .103
tela 2x1

Cover fabric



56% poliestere e 44% poliuretano. Trattamento idrorepellente, antimacchia, antimuffa e antibatterico. Solidità alla luce 7/8. Lavabile a 95° con detergente neutro - 56% polyester and 44% polyurethane. The treatment makes the coating: water repellent, and resistant to staining, resistant to mold and antibacterial. 7/8 light fastness. Washable at 95° with neutral detergent - 56% polyester et 44% polyuréthane. Traitement imperméable, anti-taches, anti-moisissures et antibactérien. Résistance à la lumière 7/8. Lavable à 95° avec un détergent neutre - 56% Polyester und 44% Polyurethan. Wasserabweisend, gegen Flecken und Schimmelbildung ausgerüstet und antibakteriell. Lichtechtheit 7/8. Waschbar bei 95° mit Neutralwaschmittel - 56%

poliéster y 44% poliuretano. Tratamiento para repeler el agua, antimanchas, antimoho y antibacteriano. Solidez a la luz 7/8. Lavable a 95° con detergente neutro - 56% de poliéster e 44% poliuretano. Tratamento hidropelente, antimancha, antimoho e antibacteriano. Resistência à luz 7/8. Lavável a 95° com detergente neutro - % 56 polyester ve % 44 poliüretan. Su Geçirmez Uygulama,kir tutmaz ve küf önleyici uygulama, antibakteriyel uygulama. Işık haslığı 7/8. Naturel deterjanla 95°de yıkanabilir - 56% poliéster ve 44% poliüretan. типы обработки: водоталкивающая,пятноталкивающая,плесеньоталкивающая, и антибактериальная устойчивость к. Светостойкость 7/8. Можно стирать при 95 ° с нейтральным моющим средством.



smoke .204
205 gr/m²

padding

CUSCINO FOLIO COMFORT

Poliuretano espanso (densità 18 kg/m³) rivestito da fibra di poliestere accoppiata al tessuto. Polyurethane foam (density 18 kg/m³) with a polyester fiber coating bonded to the fabric. Mousse polyuréthane (densité 18 kg/m³) revêtu de fibre de polyester couplé au tissu.Polyurethanschaum (Dichte 18 kg/m³) mit Polyesterfasern beschichtet, gekoppelt mit dem Gewebe. Espuma de poliuretano (densidad 18 kg/m³) cubierta con fibras de poliéster acoplada con el tejido. Espuma de poliuretano (densidade 18 kg/m³) com cobertura fibras de poliéster acoplada ao tecido. Kumaşa birleştirilmiş polyester elyafla kaplanmış genişletilmiş poliüretan (yoğunluk 18 kg/m³). Расширенный полиуретан (плотность 18 к /м³), покрытый полиэфирным волокном, соединенным с тканью.

CUSCINO NET BENCH - CUSCINO NET RELAX - CUSCINO NET

Poliuretano espanso. Densità 28 kg/m³. Polyurethane foam. Density 28 kg/m³. Mousse polyuréthane. Densité 28 kg/m³. Polyurethanschaum. Dichte 28 kg/m³. Espuma de poliuretano. Densidad 28 kg/m³. Espuma de poliuretano. Densidade 28 kg/m³. Poliüretan köpük. Yoğunluk 28 kg/m³. Пенополиуретан. Плотность 28 кг/м³.

CUSCINO SHELL NET RELAX

Poliuretano espanso su struttura rigida di polipropilene. Densità 70 kg/m³. Polyurethane foam over solid polypropylene frame. Density 70 kg/m³. Mousse polyuréthane sur structure rigide de polypropylène. Densité 70 kg/m³. Polyurethanschaum auf steifer Polypropylengestell. Dichte 70 kg/m³. Espuma de poliuretano sobre estructura rígida de polipropileno. Densidad 70 kg/m³. Espuma de poliuretano sobre estrutura rígida de polipropileno. Densidade 70 kg/m³. Sert polipropilen gövde üzerinde poliüretan köpük minder. Yoğunluk 70 kg/m³. Пенополиуретан. на жесткой конструкции из полипропилена. Плотность 70 кг/м³.

CUSCINO BIT

Poliuretano espanso (densità 17,10 kg/m³) rivestito da fibra di poliestere (densità 200 gr/m³). Polyurethane foam (density 17,10 kg/m³) with a polyester fiber coating (density 200 gr/m³). Mousse polyuréthane (densité 17,10 kg/m³) revêtu de fibre de polyester (densité 200 gr/m³). Polyurethanschaum (Dichte 17,10 kg/m³) mit Polyesterfasern beschichtet (Dichte 200 gr/m³). Espuma de poliuretano (densidad 17,10 kg/m³) cubierta con fibras de poliéster (densidad 200 gr/m³). Espuma de poliuretano (densidade 17,10 kg/m³) com cobertura fibras de poliéster (densidade 200 gr/m³). Polyester elyaf (Yoğunluk 200 gr/m³) kaplı köpük poliüretan (Yoğunluk 17,10 kg/m³). Пенополиуретан (Плотность 17,10 кг/м³) с покрытием из обшивка из полиэстера (Плотность 200 гр/м³).

CUSCINO DOGA RELAX - CUSCINO DOGA ARMCHAIR - CUSCINO DOGA BISTROT

Poliuretano espanso (densità 18 kg/m³) rivestito da fibra di poliestere (densità 100 gr/m²). Polyurethane foam (density 18 kg/m³) with a polyester fiber coating (density 100 gr/m²). Mousse polyuréthane (densité 18 kg/m³) revêtu de fibre de polyester (densité 100 gr/m²). Polyurethanschaum (Dichte 18 kg/m³) mit Polyesterfasern beschichtet (Dichte 100 gr/m²). Espuma de poliuretano (densidad 18 kg/m³) cubierta con fibras de poliéster (densidad 100 gr/m²). Espuma de poliuretano (densidade 18 kg/m³) com cobertura fibras de poliéster (densidade 100 gr/m²). Polyester elyaf (Yoğunluk 100 gr/m²) kaplı köpük poliüretan (Yoğunluk 18 kg/m³). Пенополиуретан (Плотность 18 кг/м³) с покрытием из обшивка из полиэстера (Плотность 100 гр/м²).

CUSCINO SEDUTA KOMODO

Poliuretano espanso (densità 29 kg/m³) rivestito da fibra di poliestere (densità 450 gr/m²). Polyurethane foam (density 29 kg/m³) with a polyester fiber coating (density 450 gr/m²). Mousse polyuréthane (densité 29 kg/m³) revêtu de fibre de polyester (densité 450 gr/m²). Polyurethanschaum (Dichte 29 kg/m³) mit Polyesterfasern beschichtet (Dichte 450 gr/mm²). Espuma de poliuretano (densidad 29 kg/m³) cubierta con fibras de poliéster (densidad 450 gr/m²). Espuma de poliuretano (densidade 29 kg/m³) com cobertura fibras de poliéster (densidade 450 gr/m²). Polyester elyaf (Yoğunluk 450 gr/m²) kaplı köpük poliüretan (Yoğunluk 29 kg/m³). Пенополиуретан (Плотность 29 кг/м³) с покрытием из обшивка из полиэстера (Плотность 450 гр/м²).

CUSCINO SCHIENALE KOMODO - CUSCINO SCHIENALE ANGOLO KOMODO

Poliuretano espanso (densità 18 kg/m³) rivestito da fibra di poliestere (densità 450 gr/m²). Polyurethane foam (density 18 kg/m³) with a polyester fiber coating (density 450 gr/m²). Mousse polyuréthane (densité 18 kg/m³) revêtu de fibre de polyester (densité 450 gr/m²). Polyurethanschaum (Dichte 18 kg/m³) mit Polyesterfasern beschichtet (Dichte 450 gr/m²). Espuma de poliuretano (densidad 18 kg/m³) cubierta con fibras de poliéster (densidad 450 gr/m²). Espuma de poliuretano (densidade 18 kg/m³) com cobertura fibras de poliéster (densidade 450 gr/m²). Polyester elyaf (Yoğunluk 450 gr/m²) kaplı köpük poliüretan (Yoğunluk 18 kg/m³). Пенополиуретан (Плотность 18 кг/м³) с покрытием из обшивка из полиэстера (Плотность 450 гр/м²).

CUSCINO POGGIATESTA FOLIO - CUSCINO POGGIATESTA NET LOUNGE

Fibra di Poliestere rivestito da poliestere water repellent - Polyester fiber coated with water repellent polyester - Fibre de polyester enduite de polyester hydrofuge - Mit wasserabweisendem Polyester beschichtete Polyesterfaser - Fibra de poliéster recubierta de poliéster hidrorrepelente - Fibra de poliéster revestido de poliéster resistente à água - Su geçirmez kaplamalı polyester elyaf - Полиэфирное волокно с водоотталкивающим полиэфирным покрытием.

CUSCINO SEDUTA ARIA

Poliuretano espanso. Densità 25 kg/m³. Polyurethane foam. Density 25 kg/m³. Mousse polyuréthane. Densité 25 kg/m³. Polyurethanschaum. Dichte 25 kg/m³. Espuma de poliuretano. Densidad 25 kg/m³. Espuma de poliuretano. Densidade 25 kg/m³. Poliüretan köpük. Yoğunluk 25 kg/m³. Пенополиуретан. Плотность 25 кг/м³.

CUSCINO ARREDO ARIA

Poliuretano espanso (densità 25 kg/m³) rivestito da fibra di poliestere (densità 450 gr/m²). Polyurethane foam (density 25 kg/m³) with a polyester fiber coating (density 450 gr/m²). Mousse polyuréthane (densité 25 kg/m³) revêtu de fibre de polyester (densité 450 gr/m²). Polyurethanschaum (Dichte 25 kg/m³) mit Polyesterfasern beschichtet (Dichte 450 gr/mm²). Espuma de poliuretano (densidad 25 kg/m³) cubierta con fibras de poliéster (densidad 450 gr/m²). Espuma de poliuretano (densidade 25 kg/m³) com cobertura fibras de poliéster (densidade 450 gr/m²). Polyester elyaf (Yoğunluk 450 gr/m²) kaplı köpük poliüretan (Yoğunluk 25 kg/m³). Пенополиуретан (Плотность 25 кг/м³) с покрытием из обшивка из полиэстера (Плотность 450 гр/м²).

CUSCINO PASSEPARTOUT - CUSCINO RETTANGOLARE

Fibra di poliestere. Polyester fiber. Fibre de polyester. Polyesterfasern. Fibras de poliéster. Fibras de poliéster. Polyester elyaf. Обшивка из полиэстера.

coated aluminium

La verniciatura è a polvere di poliestere - The painting is with polyester powder - La peinture est à poudre de polyester - Die Epoxierung erfolgt mit Polyesterpulver - El pintado se realiza con polvo de poliéster - O pó de



verniciato bianco .53



verniciato antracite .52



verniciato corda .69



verniciato tortora .59



verniciato tabacco .67



verniciato terra .68

glass

tempered glass

Vetro extrachiaro temperato. Spessore 6 mm - Extra-clear tempered glass. Thickness 6 mm - Verre trempé extra clair. Epaisseur 6 mm - Extra klare gehärtetes Glas. Dicke 6 mm - Vidrio templado extra claro. Espesor 6 mm



vetro .501

poliester è usado para envernizar - Boyası polyester tozla yapılır - Окраска производится при помощи порошкового полиэстера.

durelTOP



DurelTOP è un sistema innovativo di produzione di piani per tavoli studiati per raggiungere i più elevati livelli di praticità, resistenza, robustezza ed eleganza. I piani DurelTOP sono ad alto spessore, formati da un doppio strato tamburato perfettamente chiuso. Prodotti in polipropilene di prima qualità, sono inalterabili all'acqua, resistenti al sole e facili da pulire. DurelTOP è il risultato di una lunga ricerca tecnologica e dell'esperienza decennale nella lavorazione delle materie plastiche della NARDI, da sempre all'avanguardia nell'ambiente contract e giardino.

The DurelTOP is an innovative new system in the production of tabletops developed to reach the highest levels of practicality, resistance, and elegance. The DurelTOP tabletops have a greater thickness, formed by a double layer enclosure perfectly closed. Produced in first quality polypropylene, they are resistant to water, resistant to sunlight, and are easy to clean. DurelTOP is a result of a decade's long research and development in plastics by NARDI, always a leader in the contract and garden sectors.

DurelTOP est un système innovateur de production de plateaux de tables, il est étudié pour retrouver le meilleur niveau de pratique de résistance et d'élégance. Les plateaux DurelTOP sont très épais, formés de doubles couches parfaitement finies. Ce sont des produits en polypropylène de première qualité, ils sont inaltérables à l'eau, résistant au soleil et faciles à nettoyer. DurelTOP est le résultat d'une longue recherche technologique et une expérience décennale dans le travail des matières plastique de la Sté NARDI, toujours a l'avant-garde dans le secteur du contract et jardin.

DurelTOP ist ein neu entwickeltes System für die Produktion von Tischplatten, um ein Höchstmaß an Funktionalität, Widerstandsfähigkeit und Eleganz zu erreichen. Durch das innen verstärkte "Zwei-Schichten-Hohlraum-System" erreicht die DurelTOP Tischplatte einen stärkeren Querschnitt und damit ein Höchstmaß an Festigkeit. Hergestellt aus hochwertigem Qualitätspolypropylen ist sie resistent gegen Wasser und Sonnenlicht und dabei leicht zu reinigen. DurelTOP ist das Ergebnis von 10 Jahren Forschung und Entwicklung auf dem Kunststoffsek-

tor durch NARDI, immer der führende im Bereich Contract- und Gartenmöbel. DurelTOP es un nuevo sistema de fabricación de tableros de mesa estudiado para alcanzar los mas altos niveles de practicidad, resistencia, robustez y elegancia. Los tableros DurelTOP de gran solidez, estan formados por una doble capa perfectamente unida y sellada. Fabricados en polipropileno de primera calidad son inalterables al agua, resistentes al sol y de fácil limpieza. DurelTOP es el resultado de una prolongada investigación tecnológica y de la experiencia acumulada en los mas de diez años que NARDI lleva produciendo materias plasticas, siempre innovando en ambientes contract y jardin.

DurelTOP é um sistema de inovação da produção de tampos de mesa concebidos para atingir a máxima resistência,práticos e elegantes. Os tampos de mesa DurelTOP são formados poruma camada dupla e perfeitamente unida. Produzidos em polipropileno de primeira qualidade, são resistentes ao sol e fáceis de limpar. DurelTOP é o resultado de uma longa investigação tecnológica em materiais plásticos da NARDI, leader em mobiliário de jardim.

DurelTOP, masa tablalarının üretiminde kullanılan yeni bir sistem olup, yüksek seviyede pratiklik, direnç ve de ılık sunmak amacıyla geliştirilmiştir. DurelTOP masa tablaları fevkalade bir inceliğe sahip olup, kusursuz kapanan çift tabaka çevirme sistemiyle oluşturulmuştur. Nitelikli çamsakızından üretilmiş olup, suya ve güneş ışığına karşı dirençli ve temizlenmesi kolaydır. DurelTOP sistemini Contract ve de Bahçe sektöründe her zaman lider olan NARDI'nin uzun araştırmalarının sonucundan doğan, plastikte gelişim olarak adlandırabiliriz.

DurelTOP — это инновационная система производства столешниц, позволяющая изготавливать практичные, прочные, крепкие и элегантные столешницы. Столешницы DurelTOP обладают высокой плотностью и состоят из двойной панели с мелкопустотным заполнением, полностью закрытой. Изделия из полипропилен высокого качества устойчивы к воде, солнцу и просты в уходе. DurelTOP — это результат многолетних технологических исследований и десятилетнего опыта NARDI в обработке пластмасс, лидера в производстве садовой мебели и контрактном секторе.

 impilabile - stackable - empilable - stapelbar - apilable - empilhável - istiflenebilir - стекируемые

 impilabile orizzontalmente - stackable horizontally - piètement encastrable - Ineinander stapelbar - apilable horizontalmente - empilhável horizontalmente - yatay olarak istiflenebilir - горизонтальная расстановка

 pieghevole - folding - pliant - klappbar - plegable - dobrável - katlanabilir - складывающийся

 reclinabile - reclining - dossier réglable - verstellbare Rückenlehne - reclinable - reclinável - sırt pozisyonlu - откидной

Tutte le sedute sono dotate di piedini antiscivolo - All chairs are equipped with non-slip feet - Tous les sièges sont équipés avec patins anti-dérapants - Alle Stühle sind mit rutschfesten Fußkappen ausgestattet - Todos los asientos están equipados con tapones antideslizantes - Todos os assentos estão equipados com pés antiderrapantes - Bütün sandalyeler kaymaz ayaklıdır - Ножки всех стульев оснащены противоскользящей резиновой подложкой

Sui colori scuri, ombre, striature ed altri difetti minori sono più evidenti rispetto ai colori chiari e sono da ritenersi standard. On dark colors, shadows, streaks and other minor faults are more evident than on lighter colors and are therefore standard. Sur les couleurs sombres, les ombres, les stries et les autres petits défauts sont plus marqués que sur les couleurs claires et sont tout à fait standards. Auf dunklen Farben sind Schatten, Streifen und andere kleinere Mängel sichtbarer als auf hellen Farben und sind daher als Standard zu betrachten. Las sombras, rayas y demás defectos menores son más evidentes sobre los colores oscuros respecto a los colores claros y tienen que considerarse como estándares. Em cores escuras, sombras, listras e outros defeitos menores são mais evidentes do que em cores claras e devem ser considerados standard. Koyu renkler üzerinde, gölgeler, çizgiler ve diğer küçük defolar açık renkler üzerinde olduklarından daha belirginleşmekte ve bu nedenle normal olarak değerlendirilmelidirler. По сравнению со светлыми цветами на темных цветах тени полоска и другие небольшие дефекты более заметны и должны считаться нормой.

Il peso (kg), le misure (cm) e i colori riportati sono indicativi. Le dimensioni riportate di tutti i prodotti hanno una tolleranza di + o - 5 mm. NARDI si riserva il diritto di apportare modifiche o varianti senza preavviso. Tutti i modelli sono depositati. Weights (kg), dimensions (cm) and colors are indicative only. The dimensions given for all products have a tolerance of + or - 5 mm. NARDI reserves the right to make changes or variations without notice. All models are patented. Le poids (kg), les dimensions (cm) et les coloris indiqués sont fournis purement à titre indicatif. Les dimensions indiquées de tous les produits ont une tolérance de + ou - 5 mm. NARDI se réserve le droit d'apporter toute modification ou variation sans aucun préavis. Tous les modèles sont déposés. Alle Farb-, Maß-, (cm) und Gewichtsangaben (kg) sind nicht als fest bindend anzusehen. Die angegebenen Maße aller Produkte unterliegen einer Toleranz von + oder - 5 mm. NARDI behält sich das Recht von Änderungen. Alle Modelle sind gesetzlich geschützt. El peso (kg), las medidas (cm) y los colores detallados, son indicativos. Las dimensiones indicadas de todos los productos tienen una tolerancia de + o - 5 mm. NARDI se reserva el derecho de modificaciones o variaciones sin previo aviso. Todos los modelos llevan nuestra marca. O peso (kg), as medidas (cm) e as cores indicadas, são indicativos. As dimensões mostradas de todos os produtos têm uma tolerância de + ou - 5 mm. NARDI reservase o direito de aportar modificações ou variações sem préaviso. Todos os modelos estão depositados. Ağırlık (Kg), boyutlar (cm) ve renkler gösterme amaçlıdır. Tüm ürünler için verilen .l.üler + ya da - 5 mm toleransa sahiptir. (3 5 mm) NARDI'nin önceden bildirmeden değişiklik yapma hakkı vardır. Bütün modeller patentlidir. Приведенный вес (кг), размеры (см) и цвета являются ориентировочными. Размеры всех изделий приводятся с допуском + / - 5 мм. Компания NARDI оставляет за собой права вносить изменения и вариации без предварительного предупреждения. Все модели зарегистрированы.

STYLING

Vanessa Pisk

Elisa Musso

Studio Salaris

Cristina Nava

Elena Mora

THANKS TO

Aytm

Bitossi Home

Bloomingville

Ichendorf

Incipit Lab

L'Abitare

Normann Copenhagen

Karpeta

Flos Outdoor

GRAPHIC DESIGN PHOTO

Studio Raffaello Galiotto



10101109

NARDI s.p.a.
Chiampo (VI) Italy
tel. +39 0444 422100
info@nardioutdoor.com
www.nardioutdoor.com



