



ONE-TOUCH® PREMIUM CHARCOAL GRILL

Read owner's guide before using the barbecue.

Lisez le guide d'utilisation avant d'utiliser le barbecue.

Lesen Sie das Benutzerhandbuch, bevor Sie den Grill verwenden.

18½ inch
(47 cm)

22½ inch
(57 cm)



EXPLODED VIEW, VUE ÉCLATÉE, EXPLOSIONSDARSTELLUNG

One-Touch® Premium Euro 061711

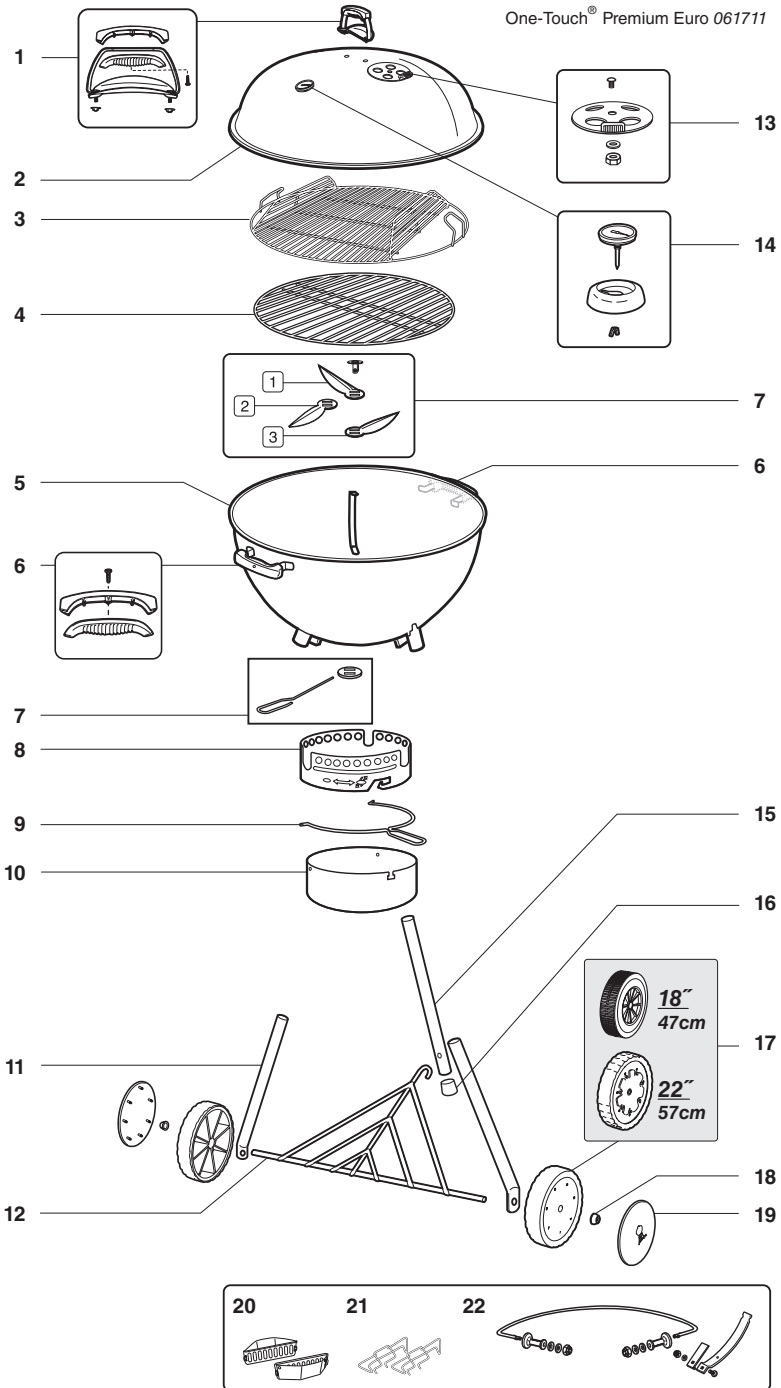

- | | |
|--|---|
| <p>1. Lid Handle Assembly
Poignée du couvercle
Deckelgriff</p> | <p>11. Wheel Leg
Pied à roue
Bein für Rad</p> |
| <p>2. Lid
Couvercle
Deckel</p> | <p>12. Triangle
Triangle
Dreieck</p> |
| <p>3. Hinged Cooking Grate
Grille de cuisson articulée
Klapp-Grillrost</p> | <p>13. Lid Damper Assembly
Aération de couvercle
Deckeldämpfer</p> |
| <p>4. Charcoal Grate
Foyère
Holzkohlerost</p> | <p>14. Thermometer Assembly
Thermomètre
Thermometer</p> |
| <p>5. Bowl
Cuve
Kessel</p> | <p>15. Front Leg
Pied avant
Vorderes Bein</p> |
| <p>6. Bowl Handle Assembly
Poignée de la cuve
Kesselgriff</p> | <p>16. Front Leg Cap
Capuchon de pied avant
Kappe für Vorderbein</p> |
| <p>7. One-Touch Damper Assembly
Aération One-Touch®
One-Touch®-System</p> | <p>17. Wheel
Roue
Rad</p> |
| <p>8. Ash Catcher Ring
Support de cendrier
Haltering für Aschetopf</p> | <p>18. Hub Cap
Fixation de roue
Nabenkappe</p> |
| <p>9. Ash Catcher Handle
Poignée de cendrier
Griff für Aschetopf</p> | <p>19. Wheel Cover
Cache-roue
Radkappe</p> |
| <p>10. High Capacity Ash Catcher
Cendrier grande capacité
Aschetopf mit großem Fassungsvermögen</p> | |

MAY INCLUDE, PEUT INCLURE, KANN ENTHALTEN

- | | |
|---|--|
| <p>20. Charcoal Baskets
Paniers à charbon
Holzkohlekörbe</p> | <p>21. Wire Rails
Rails métalliques
Holzkohlehalter</p> |
| <p>22. Lid Holder & Lower Support Assembly
Guide-couvercle et support inférieur
Deckelhalter mit Führung</p> | |

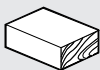

1-

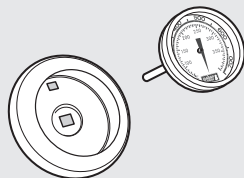
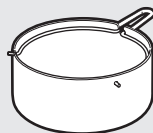
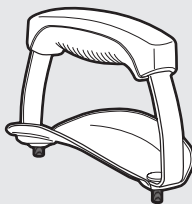
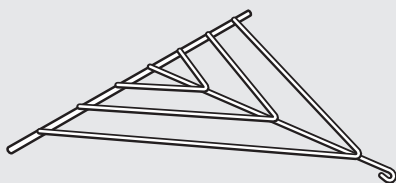
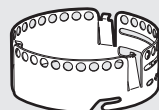
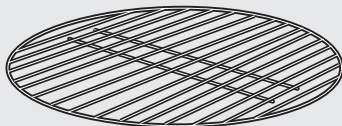
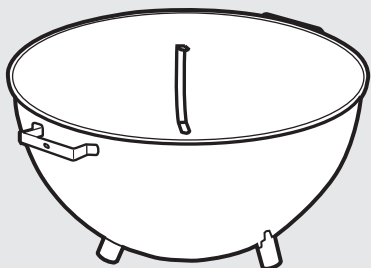
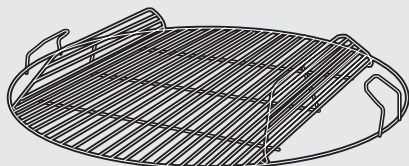
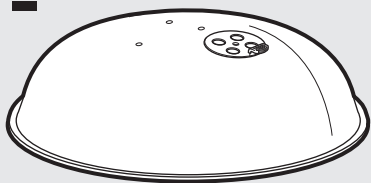

2-

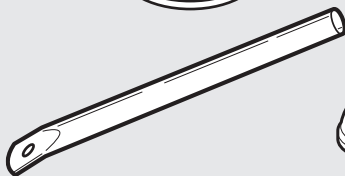
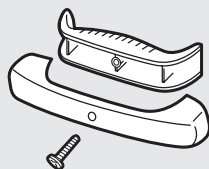
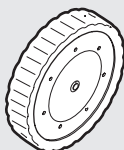

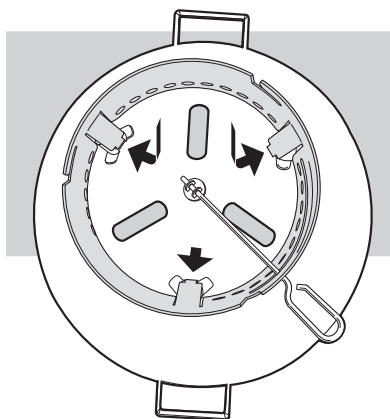
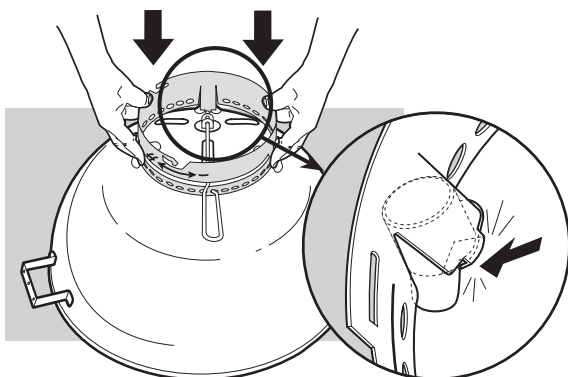
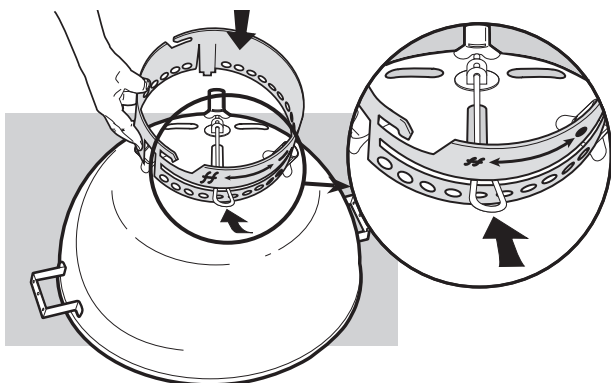

2

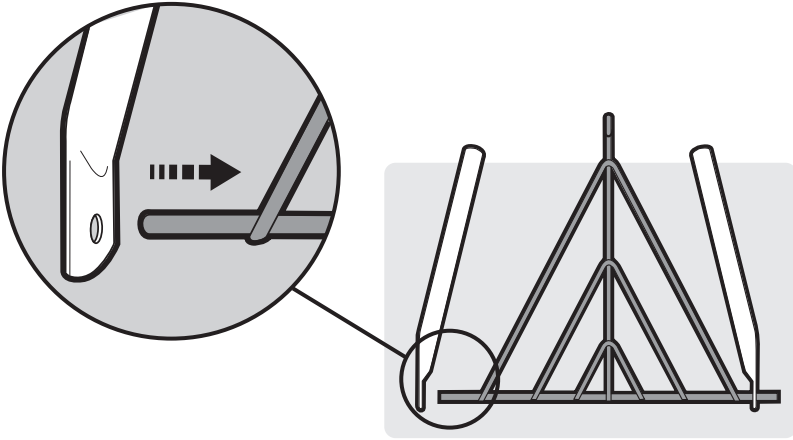

3

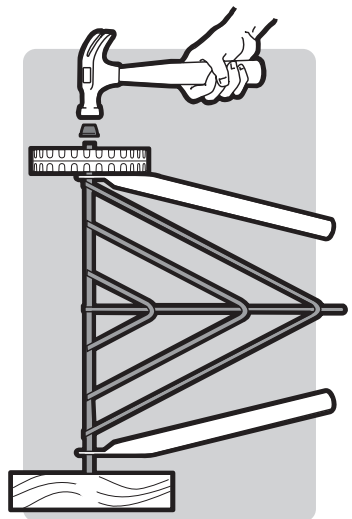
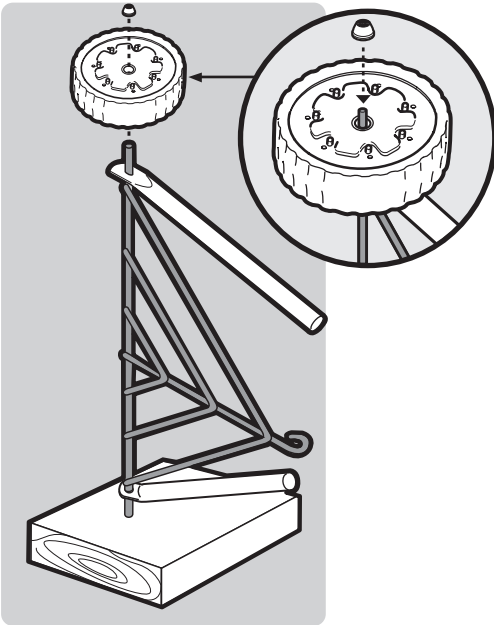
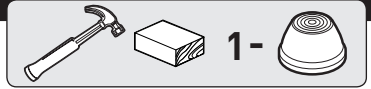

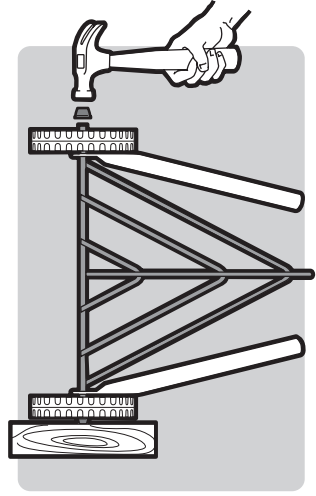
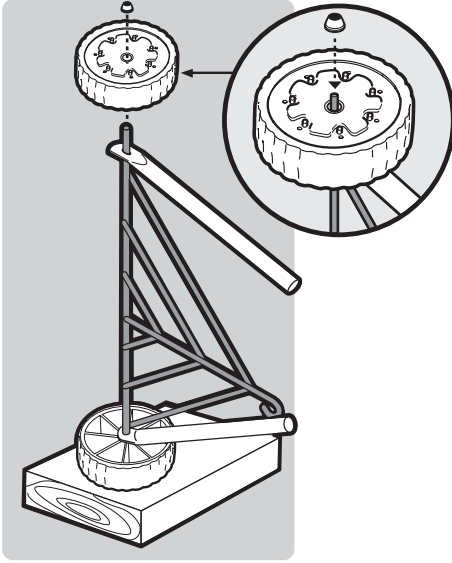
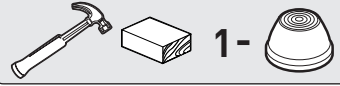

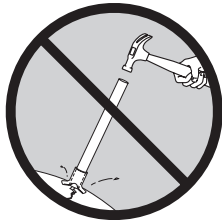
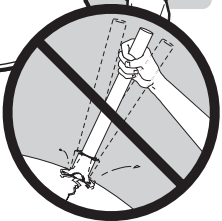
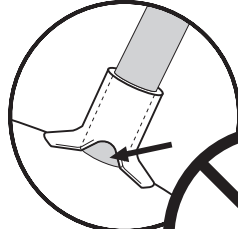
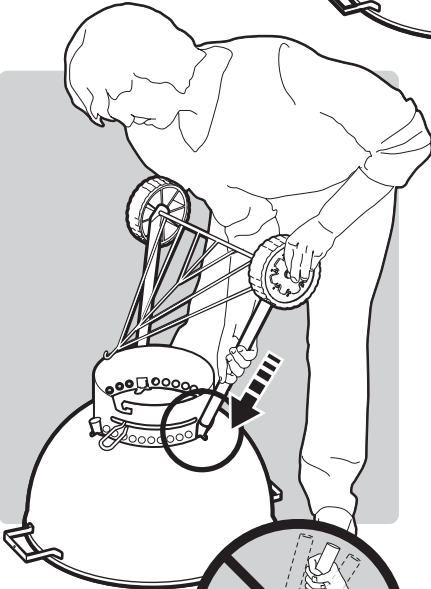
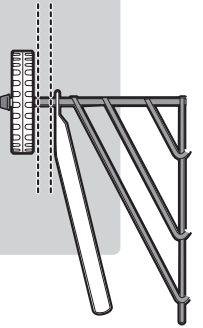
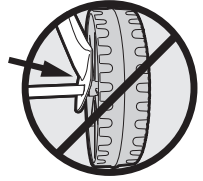
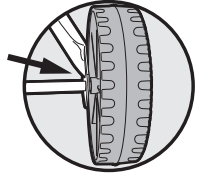
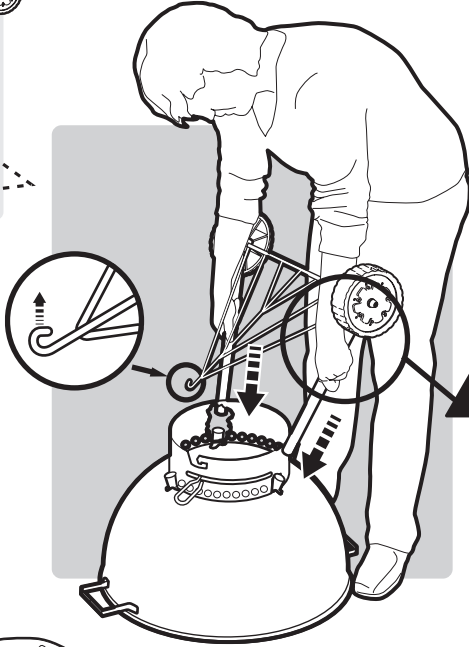
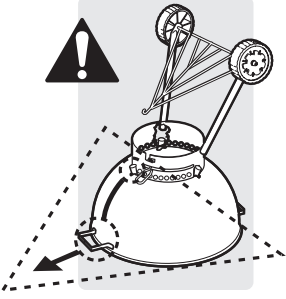

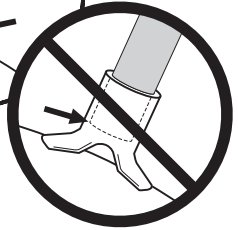
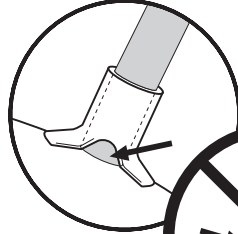
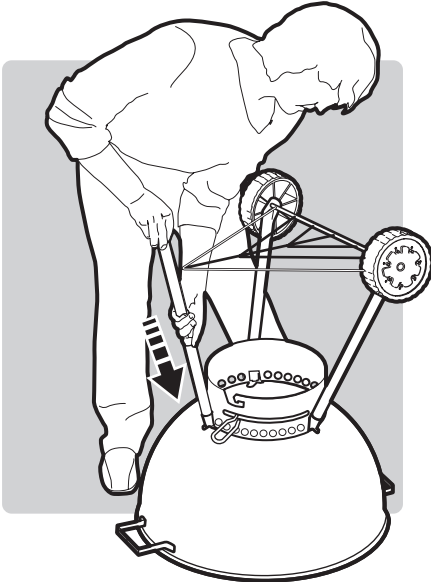
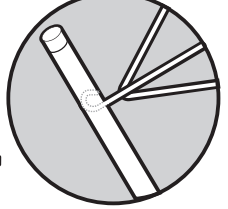
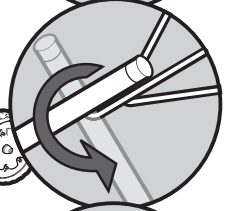
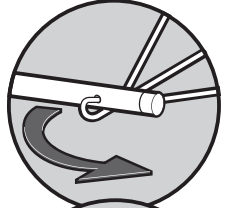
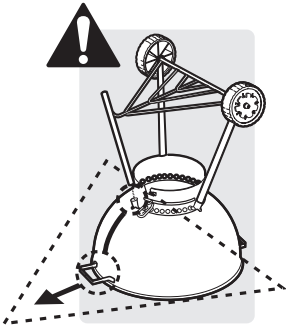
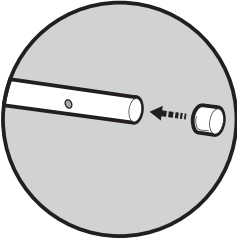

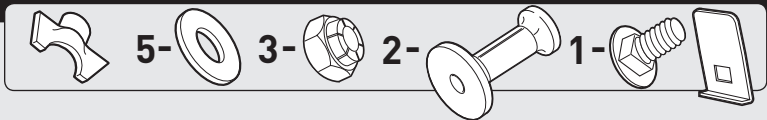

MAY INCLUDE:

- (FI) VOI SISÄLTÄÄ:
- (FR) ACCESSOIRES POSSIBLES:
- (IT) IL BARBECUE PUÒ ESSERE PROVISTO DI:
- (NO) KAN INNEHOLDE:
- (DA) KAN INDEHOLDE:
- (ES) PUEDE INCLUIR:
- (SV) KAN INKLUDERA:
- (DE) KANN ENTHALTEN:
- (NL) KAN HET VOLGENDE BEVATTEN:
- (PT) PODE INCLUIR:
- (PL) ZESTAW MOŻE ZAWIERAĆ:
- (RU) МОЖЕТ ВХОДИТЬ В КОМПЛЕКТ:
- (UK) МОЖЕ ВХОДИТИ ДО КОМПЛЕКТУ:
- (HU) TARTALMAZHATJA AZ ALÁBBIAKAT:
- (RO) POATE CONȚINE:
- (BG) МОЖЕ ДА ВКЛЮЧВА:
- (SL) LAHKO VKLJUČUJE:
- (SK) MÔŽE OBSAHOVAŤ:
- (HR) MOŽE UKLJUČIVATI:
- (CS) MŮŽE OBSAHOVAT:
- (IS) GETUR FYLGT:
- (TR) ÇIKABILECEK AKSESUARLAR:
- (EL) ΜΠΟΡΕΙ ΝΑ ΠΕΡΙΛΑΜΒΑΝΕΙ:

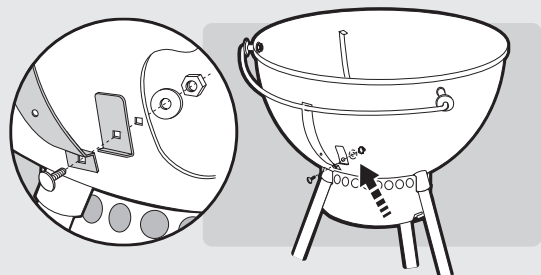
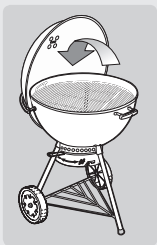
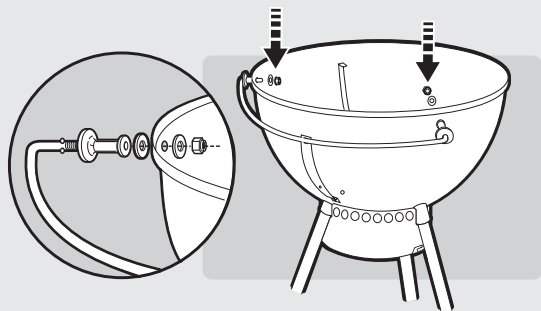
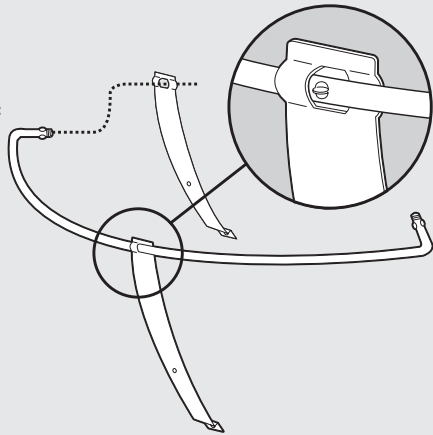

8

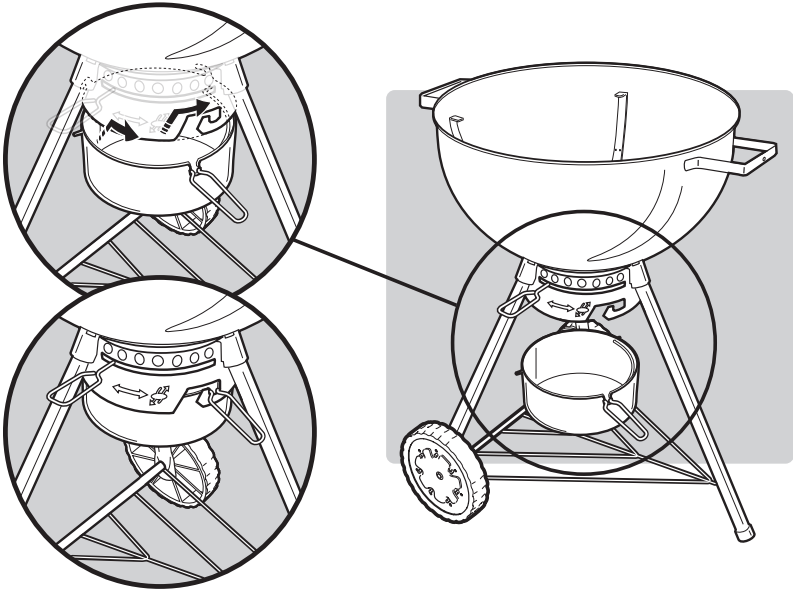

9

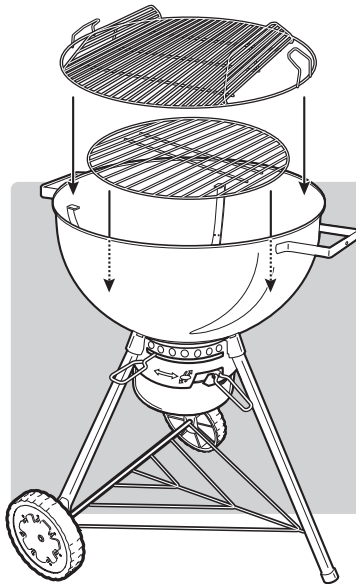

10

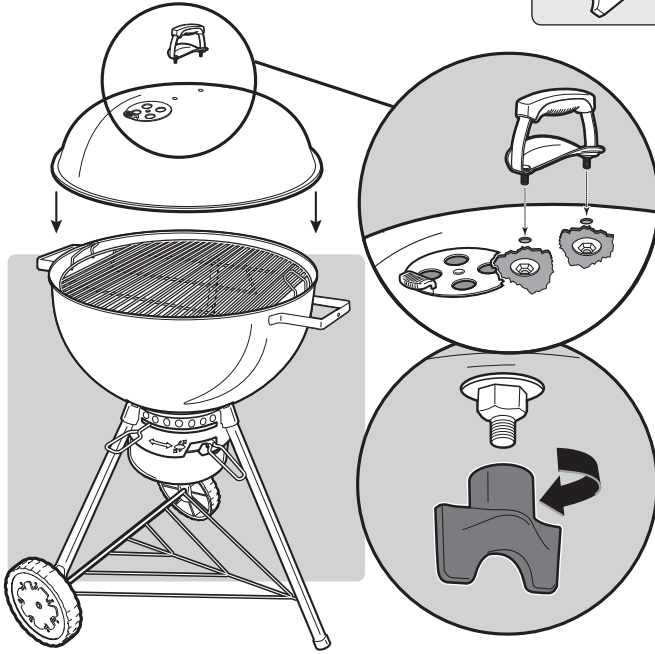

11

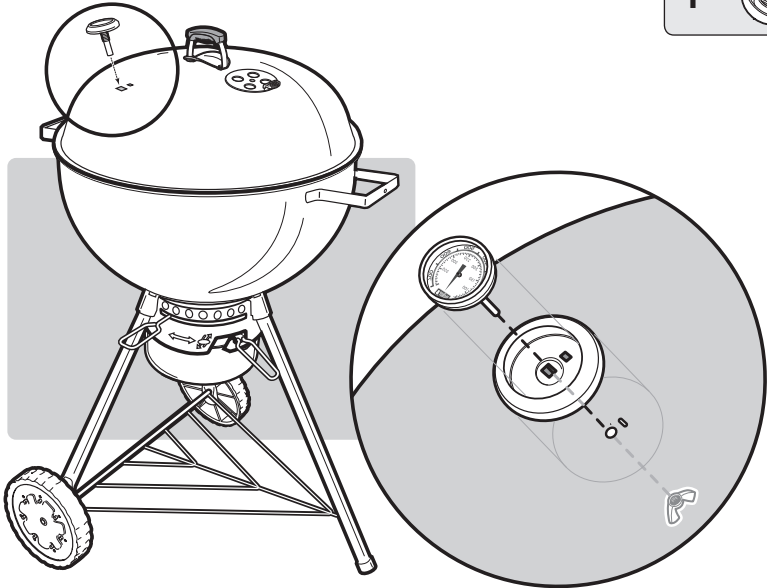

12

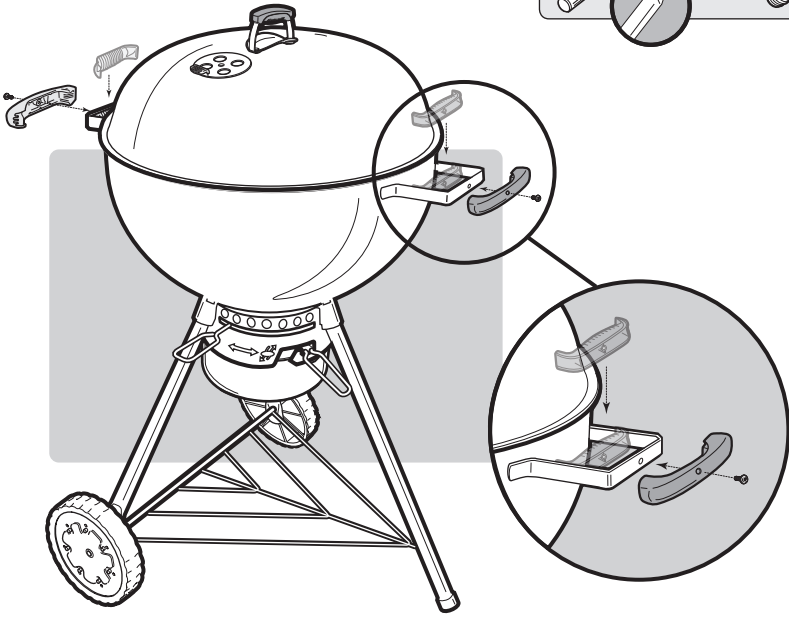
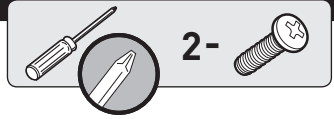

13

14

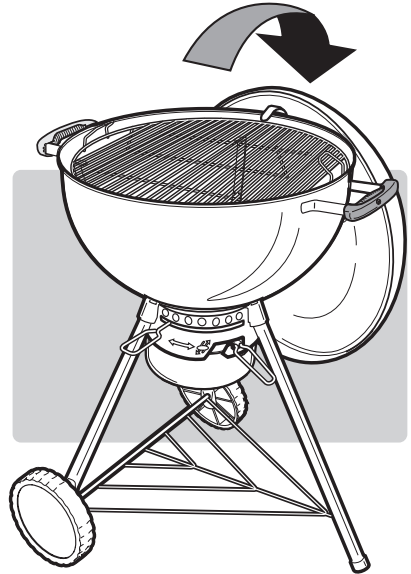
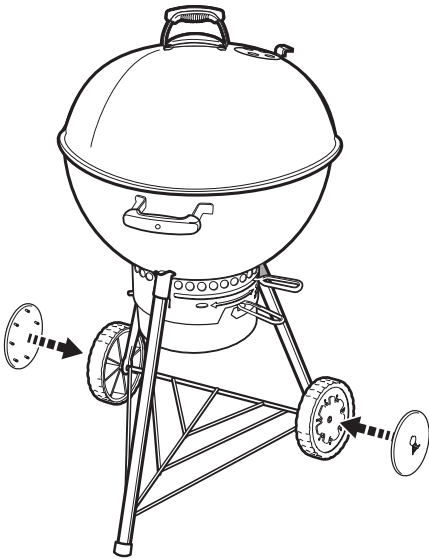

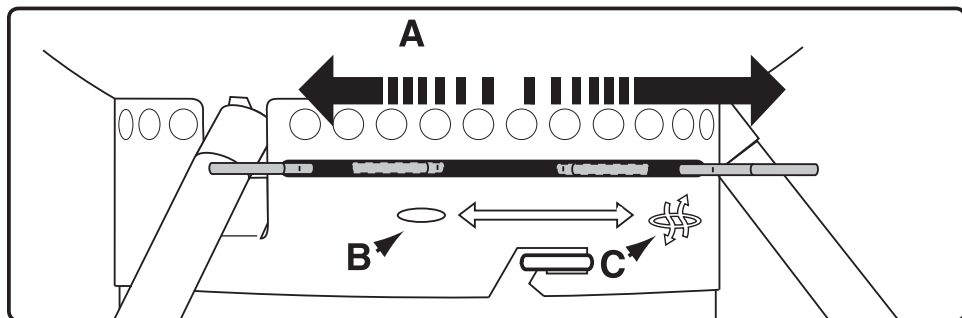

EN

A - Clear ashes B - Vents closed C - Vents open

△ **WARNING:** When using liquid starters always check ash catcher before lighting. Fluid can collect in the ash catcher and could ignite, resulting in a fire below the bowl. Remove any starting fluid from the ash catcher before lighting charcoal.

FI

A - Poista tuhka B - Ilmareiät suljettu C - Ilmareiät auki

△ **VAROITUS!** Sytytysnestettä käytettäessä tarkista aina tuhkankeruustia ennen sytytystä. Nestettä voi kerääntyä tuhkankeruustiaan ja se voi syttyä aiheuttaen tulen grillin alla. Poista mahdollinen sytytysneste tuhkankeräysastiasta ennen brikettien sytyttämistä.

FR

A - Evacuation des cendres B - Clapets fermés C - Clapets ouverts

△ **AVERTISSEMENT:** Lorsque vous utilisez du liquide d'allumage, vérifiez toujours le cendrier avant d'allumer. Le liquide risque de s'écouler dans le cendrier et de s'y enflammer, provoquant ainsi un feu sous le foyer. Retirez tout fluide de démarrage de l'attrape-cendres avant d'allumer le charbon de bois.

IT

A - Eliminare la cenere B - Prese d'aria chiuse C - Prese d'aria aperte

△ **AVVERTENZA:** quando si usano prodotti liquidi per accendere la carbonella, occorre controllare sempre il raccogli cenere prima procedere. È possibile infatti che del fluido si raccolga nel raccogli cenere e prenda fuoco causando un incendio sotto il barbecue. Prima di accendere il carbone, rimuovere eventuali liquidi accendifuoco dal raccogli cenere.

NO

A - Tøm aske B - Ventilert lukket C - Ventilert åpne.

△ **ADVARSEL:** Når tennvæske benyttes må askeoppsamler alltid sjekkes før tenning. Væske kan samle seg i askeoppsamleren og antennes, som resulterer i brann under kjelen. Fjern opprenningsvæske fra askeoppsamleren før brikettene tennes.

DA

A - Fjern asken B - Spjældene lukkede C - Spjældene åbne

△ **ADVARSEL:** Når tændvæske bruges, må askebakken altid efterses før tænding. Væske kan samle sig i askebakken og antænde, så brand kan opstå nedenfor der kedlen. Fjern eventuel tændvæske fra askeskuffen, inden kullene antændes.

ES

A - Eliminación de la ceniza B - Orificios cerrados C - Orificios abiertos

△ **ADVERTENCIA:** Si usa fluidos para encender el carbón, revise siempre el recogedor de cenizas antes de encender. El fluido que puede acumularse en el recogedor de cenizas podría inflamarse y provocar un incendio debajo de la olla. Elimine cualquier fluido de encendido en el recolector de cenizas antes de encender el carbón vegetal.

SV

A - Tömmer askan B - Spjällen stängda C - Spjällen öppna

△ **WARNING:** Om tändvätska används skall askfångaren alltid kontrolleras innan kolen tänds, eftersom tändvätska kan rinna ner i askfångaren, antändas och börja brinna under grillen. Avlägsna all tändvätska från askuppsamlaren innan grillbriketterna antänds.

DE

A - Asche entfernen B - Belüftungsöffnungen geschlossen C - Belüftungsöffnungen offen

△ **WARNHINWEIS:** Bei Verwendung von flüssigen Grillanzündern muß vor dem Anzünden stets der Aschenauffang geprüft werden. Selbst eine geringe Ansammlung von Zündflüssigkeit im Aschenauffang könnte sich entzünden und ein Feuer unter der Grillkugel verursachen. Achten Sie darauf, dass sich vor dem Anzünden der Holzkohle keine Brennflüssigkeit in der Aschenauffangschale befindet.

NL

A - As opruimen B - Openingen gesloten C - Openingen open

△ **WAARSCHUWING:** Controleer de asla altijd voordat u vloeibare aansteekvloeistof gebruikt. De vloeistof kan zich in de asla ophopen en kan ontsteken, hetgeen tot brand onder de barbecue kan leiden. Verwijder alle aanmaakvloeistof uit de asschaal voordat u de briketten aansteekt.

PT

A - Limpe as cinzas B - Orifícios fechados C - Orifícios abertos

△ **ATENÇÃO:** Quando estiver usando fluidos líquidos para acendimento, verifique antes o coletor de cinzas. O fluido pode ficar acumulado no coletor e provocar fogo embaixo do recipiente. Retire todos os fluidos de ignição do coletor de cinzas antes de acender o carvão.

PL

A - Wysyp popioł B - Otwory wentylacyjne zamknięte C - Otwory wentylacyjne otwarte

△ **OSTRZEŻENIE:** Jeśli używasz płynnej podpałki, zawsze przed rozpaleniem ognia sprawdź popielnik. W popielniku mógł zgromadzić się płyn, który może się zapalić. Usunąć płyn do rozpalania z popielnika przed rozpaleniem węgla.

RU

A - Очистить золу B - Вентиляционные отверстия закрыты C - Вентиляционные отверстия открыты

△ **ПРЕДУПРЕЖДЕНИЕ:** При использовании жидкостных зажигателей, всегда проверяйте золоуловитель перед розжигом. Жидкость может скапливаться в золоуловителе и может загореться, приводя к воспламенению под чашей гриля. Удалите любую жидкость от золоуловителя перед розжигом древесного угля.

UK

A - Вилучення золи B - Отвори закриті C - Отвори відкриті

△ **ПОПЕРЕДЖЕННЯ:** При використанні рідин для розпалювання завжди перевіряйте золоуловлювач перед запалюванням. Рідина може накопичуватись в золоуловлювачі й запалитися, що спричинить пожежу під чашею. Вилучити рідину для запалювання з золоуловлювача перед розпаленням деревного вугілля.

HU

A - Hamu eltávolítva B - Szellőzőnyílások bezárva C - Szellőzőnyílások nyitva

△ **FIGYELMEZTETÉS:** A folyékony begyújtóanyagot használ, begyújtás előtt minden esetben ellenőrizze a hamufelfogó tálcát. A folyadék összegyűlhet a hamufelfogó tálcában és meggyulladhat, ami tűzhöz vezethet a teknő alatt. A faszén begyújtása előtt az összes begyújtófolyadékot távolítsa el a hamufelfogó tálcából.

RO

A - Îndepărtarea cenușii B - Aerisiri închise C - Aerisiri deschise

△ **AVERTIZARE:** Dacă utilizați lichide de aprindere, verificați întotdeauna tava de cenușă înainte de a aprinde. Lichidul se poate colecta în tava de cenușă și se poate aprinde, generând o flacără sub vasul grătarului. Înainte de a aprinde cărbunii, îndepărtați lichidul de aprindere din tava de cenușă.

BG

A – Изчистена пепел B – Затворени клапани C – Отворени клапани

⚠ **ПРЕДУПРЕЖДЕНИЕ:** Когато използвате течности за запалване, винаги проверявайте пепелника преди запалване. Течността може да се събере в пепелника и да се възпламени, което да доведе до огън под купата. Отстранете запалителната течност от пепелника преди запалване на въглищата.

SL

A – Odstranite pepel B – Oddušniki zaprti C – Oddušniki odprti

⚠ **OPOZORILO:** Pri uporabi tekočih sredstev za vžig vedno preverite lovilnik pepela pred vžigom. Tekočina se lahko nabere v lovilniku pepela in se vžge ter povzroči požar v posodi. Preden prižgete oglje, odstranite vso tekočino za vžig iz lovilnika pepela.

SK

A – Odstráňte popol B – Vetracie otvory zatvorené C – Vetracie otvory otvorené

⚠ **VAROVANIE:** Pri použití tekutých zapaľovačov vždy pred zapálením skontrolujte zachytávač popola. Kvapalina sa môže nazbierať v zachytávači popola a vznietiť, čím spôsobí oheň pod miskou. Odstráňte zo zachytávača popola pred zapálením dreveného uhlia všetku zapaľovaciu tekutinu.

HR

A – očistite pepeo B – otvori za zrak su zatvoreni C – otvori za zrak su otvoreni

⚠ **UPOZORENJE:** Kad koristite tekućinu za paljenje uvijek prije paljenja provjerite posudu za prihvat pepela. Tekućina se može sakupljati u posudi za prihvat pepela i može se zapaliti, dovodeći do vatre ispod posude. Uklonite svu tekućinu za paljenje iz posude za prihvat pepela prije paljenja ugljena.

CS

A – Popel odstraněn B – Průduchy uzavřené C – Průduchy otevřené

⚠ **VAROVÁNÍ:** Při používání tekutých startérů vždy před zapálením nejprve zkontrolujte nádobu na popel. Tekutina se může v nádobě na popel shromažďovat, což může způsobit zapálení a následný požár pod kotlem. Před zapálením dřevěného uhlí vždy odstraňte veškerou startovací tekutinu z nádoby na popel.

IS

A – Hreinsa ösku B – Loftgöt lokuð C – Loftgöt opin

⚠ **VIÐVÖRUN:** Þegar notaður er kveikivökvi skal kannaður öskusafnarinn áður en kveikt er. Vökvi getur safnast í öskusafnarann, sem gæti kviknað í og orðið að báli undir grillbotninum. Fjarlægja skal allan kveikivökva úr öskusafnarannum áður en kveikt er í viðarkolunum.

TR

A – Külleri temizleyin B – Havalandırma kanalları kapalı C – Havalandırma kanalları açık

⚠ **UYARI:** Tutuşturma sıvıları kullanılacaksa, yakmadan önce kül tutucuyu kontrol edin. Bu sıvı, kül tutucuda birikebilir ve tutuşarak barbekünün atında ateş çıkartabilir. Kömürü yakmadan önce, varsa kül tutucudaki tutuşturma sıvılarını temizleyin.

EL

A – Καθαρή στάχτη B – Οπές αερισμού κλειστές C – Οπές αερισμού ανοιχτές

⚠ **ΠΡΟΕΙΔΟΠΟΙΗΣΗ:** Όταν χρησιμοποιείτε υγρούς αναπτήρες ελέγχετε πάντα τον συλλέκτη στάχτης πριν από την έναυση. Μπορεί να συγκεντρωθεί υγρό στο συλλέκτη στάχτης και να αναφλεγεί με αποτέλεσμα φωτιά κάτω από τη λεκάνη, Απομακρύνετε οποιοδήποτε είδους υγρό αναπτήρα από τον συλλέκτη στάχτης πριν ανάψετε τα κάρβουνα.



WEBER-STEPHEN PRODUCTS LLC

www.weber.com®