



# ONE-TOUCH® MASTER-TOUCH™ GBS™ CHARCOAL GRILL

Read owner's guide before using the barbecue.

Lisez le guide d'utilisation avant d'utiliser le barbecue.

Lesen Sie das Benutzerhandbuch, bevor Sie den Grill verwenden.

22½ inch  
(57 cm)

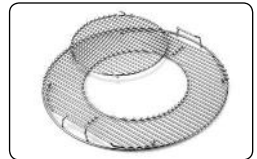

# EXPLODED VIEW, VUE ÉCLATÉE, EXPLOSIONSDARSTELLUNG

Master-Touch® 57 cm Euro 090512

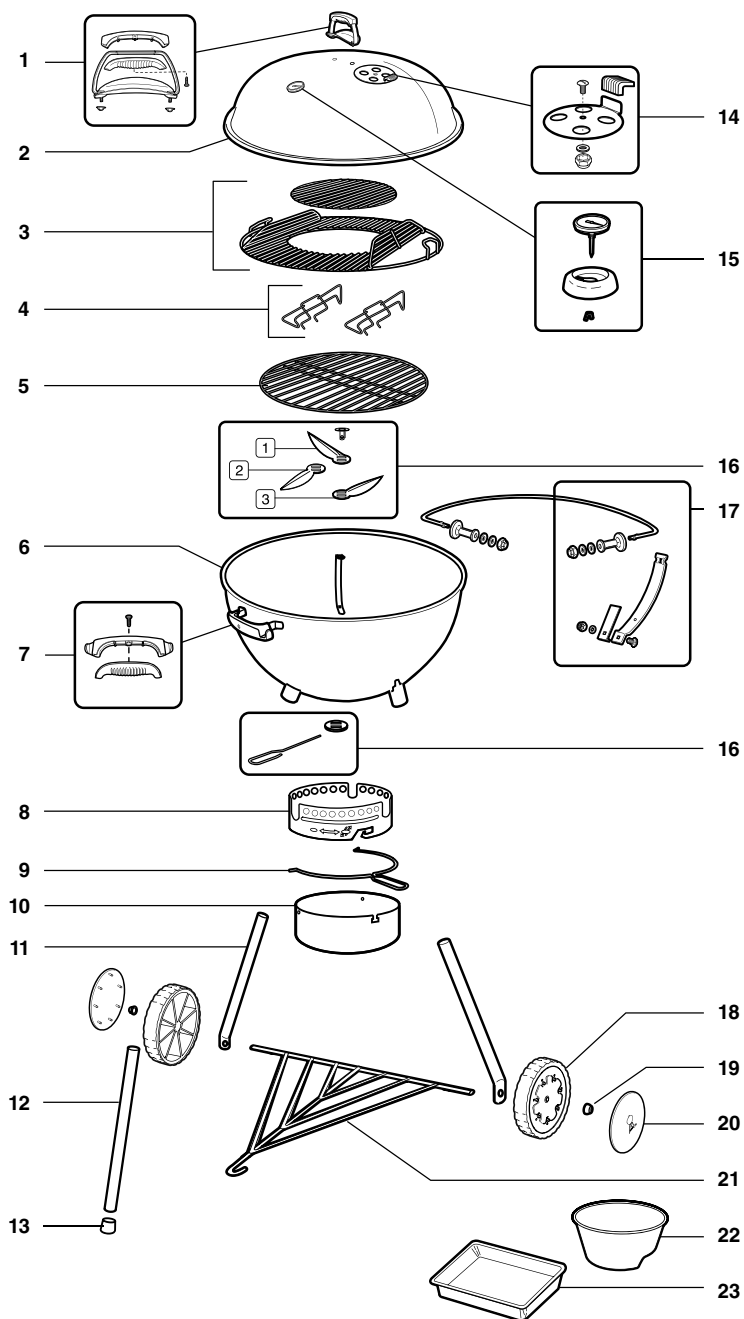

- |  |  |
|--|--|
| <p><b>1. Lid Handle Assembly</b><br/>Poignée du couvercle<br/>Deckelgriff</p> <p><b>2. Lid</b><br/>Couvercle<br/>Deckel</p> <p><b>3. Hinged Cooking Grate (GBS™)</b><br/>Grille de cuisson articulée (GBS™)<br/>Klapp-Grillrost (GBS™)</p> <p><b>4. Charcoal Rails</b><br/>Rail pour charbon de bois<br/>Holzkohleschiene</p> <p><b>5. Charcoal Grate</b><br/>Foyère<br/>Holzkohlerost</p> <p><b>6. Bowl</b><br/>Cuve<br/>Kessel</p> <p><b>7. Bowl Handle Assembly</b><br/>Poignée de la cuve<br/>Kesselgriff</p> <p><b>8. Ash Catcher Ring</b><br/>Support de cendrier<br/>Haltering für Aschetopf</p> <p><b>9. Ash Catcher Handle</b><br/>Poignée de cendrier<br/>Griff für Aschetopf</p> <p><b>10. High Capacity Ash Catcher</b><br/>Cendrier grande capacité<br/>Aschetopf mit großem Fassungsvermögen</p> <p><b>11. Wheel Leg</b><br/>Pied à roue<br/>Bein für Rad</p> <p><b>12. Front Leg</b><br/>Pied avant<br/>Vorderes Bein</p> | <p><b>13. Front Leg Cap</b><br/>Capuchon de pied avant<br/>Kappe für Vorderbein</p> <p><b>14. Lid Damper Assembly</b><br/>Aération de couvercle<br/>Deckeldämpfer</p> <p><b>15. Thermometer Assembly</b><br/>Thermomètre<br/>Thermometer</p> <p><b>16. One-Touch Damper Assembly</b><br/>Aération One-Touch®<br/>One-Touch®-System</p> <p><b>17. Lid Holder &amp; Lower Support Assembly</b><br/>Guide-couvercle et support inférieur<br/>Deckelhalter mit Führung</p> <p><b>18. Wheel</b><br/>Roue<br/>Rad</p> <p><b>19. Hub Cap</b><br/>Fixation de roue<br/>Nabenkappe</p> <p><b>20. Wheel Cover</b><br/>Cache-roue<br/>Radkappe</p> <p><b>21. Triangle</b><br/>Triangle<br/>Dreieck</p> <p><b>22. Charcoal Cup</b><br/>Doseur à Charbon de Bois<br/>Brikett-Portionierer</p> <p><b>23. Disposable Drip Pan</b><br/>Barquette en aluminium jetable<br/>Einweg-Tropfschale</p> |
|--|--|



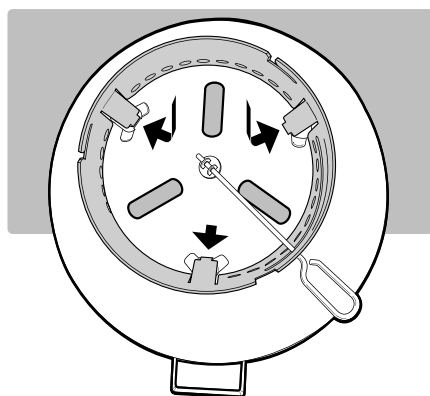
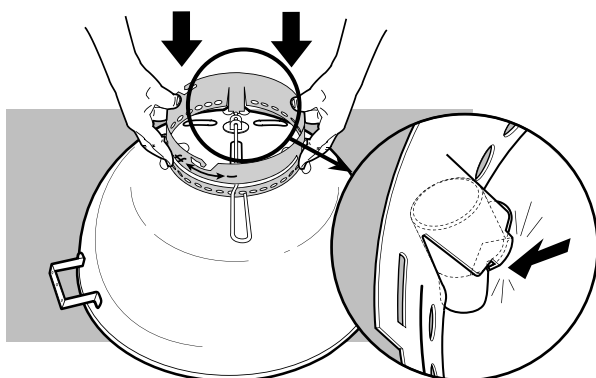
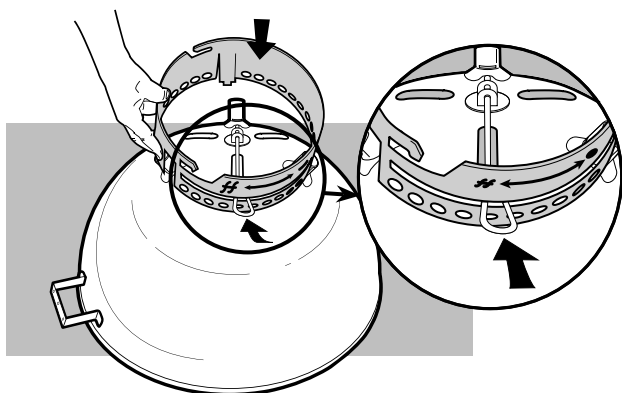

2

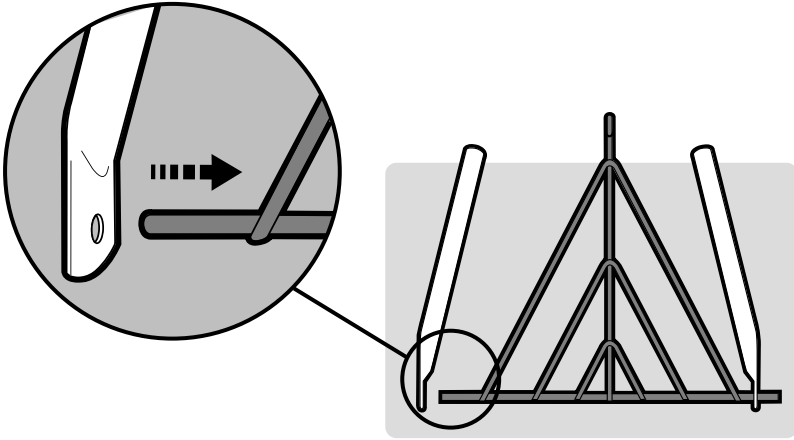

3

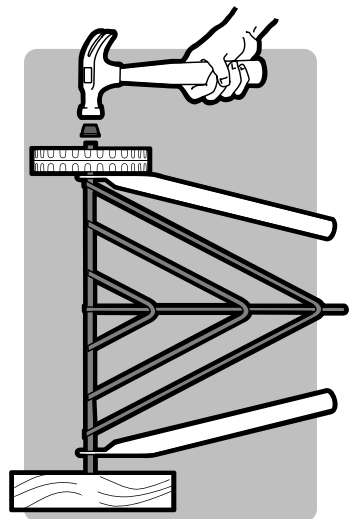
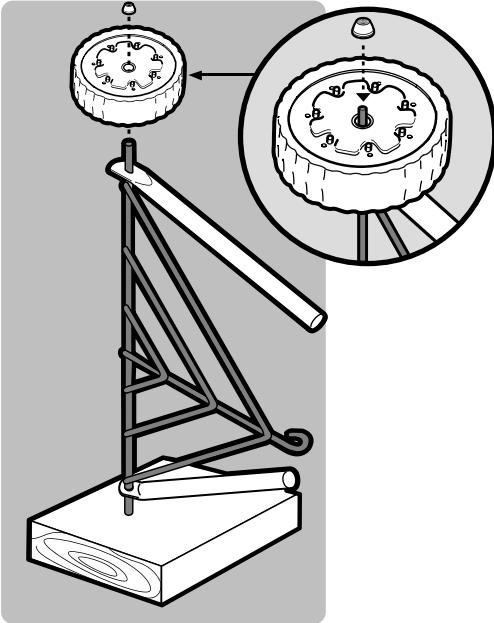
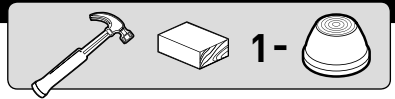



1-

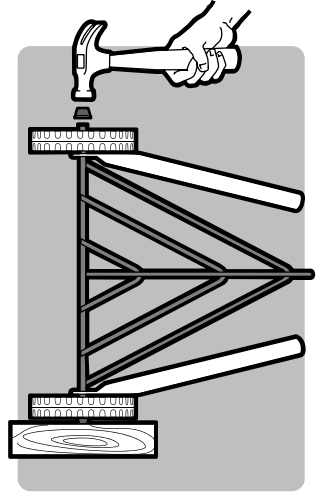
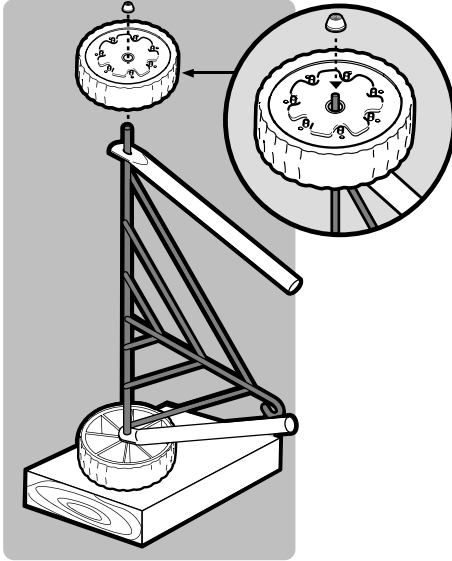

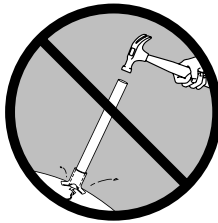
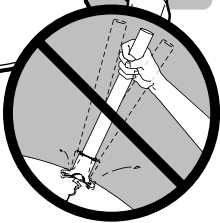
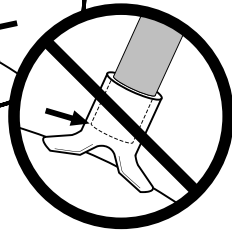
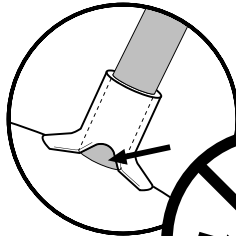
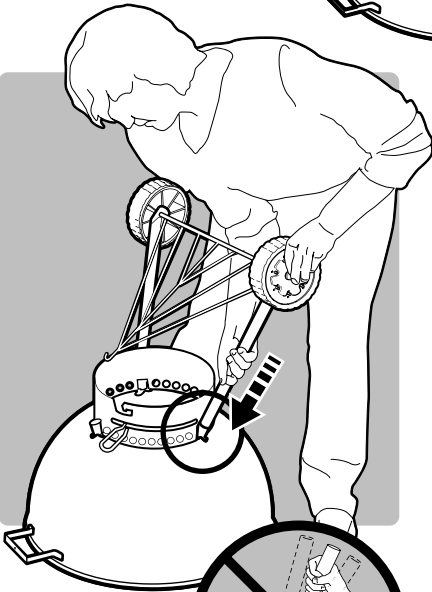
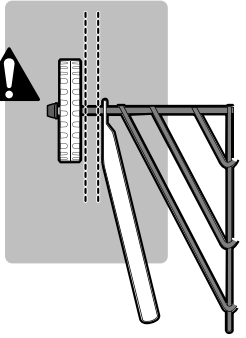
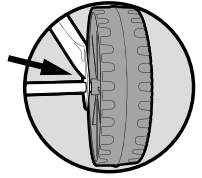
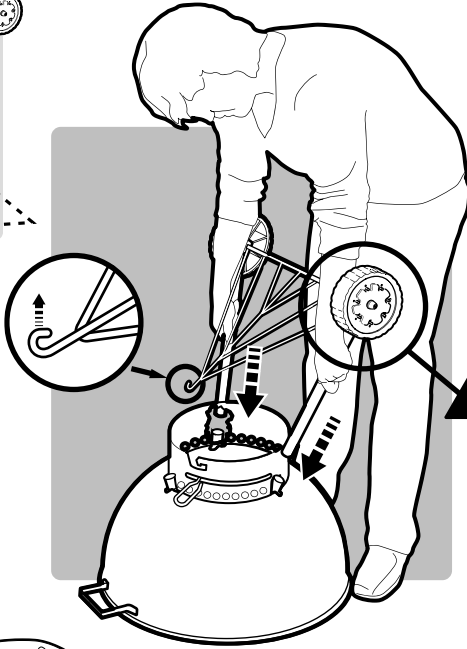
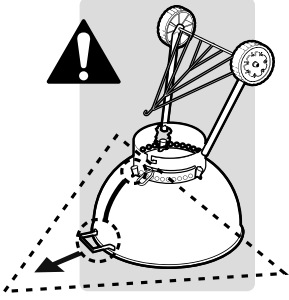



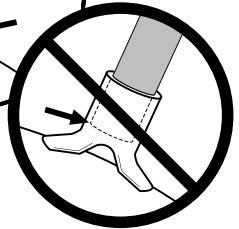
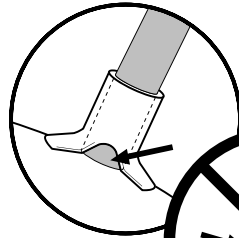
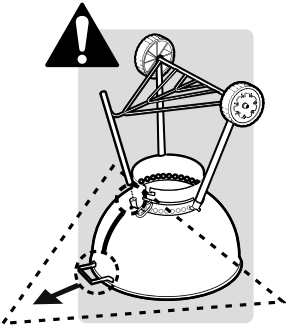
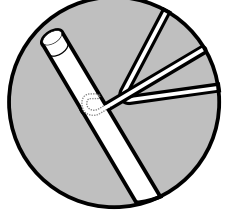
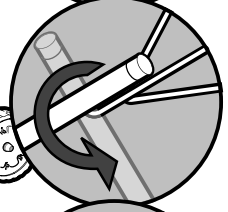
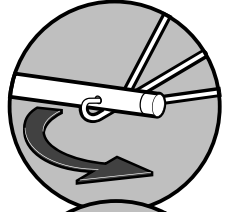
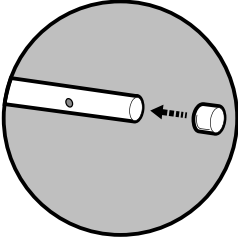

# 7

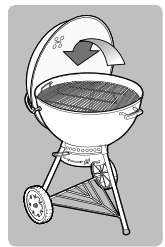
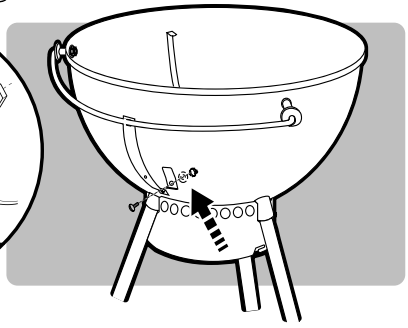
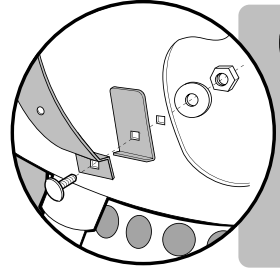
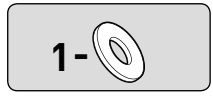
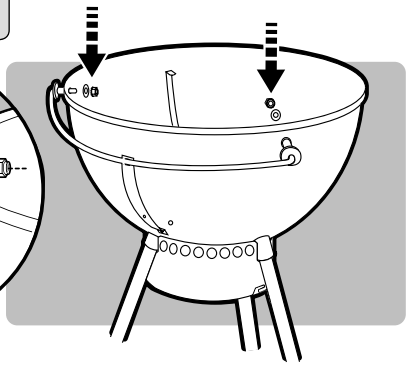
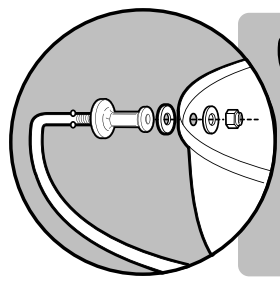
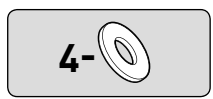
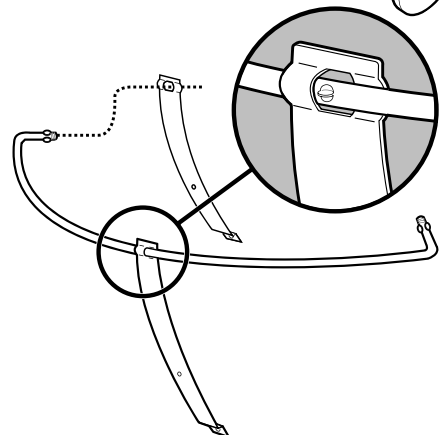
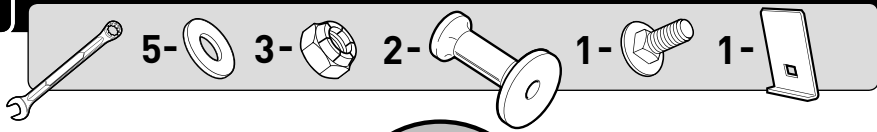

8

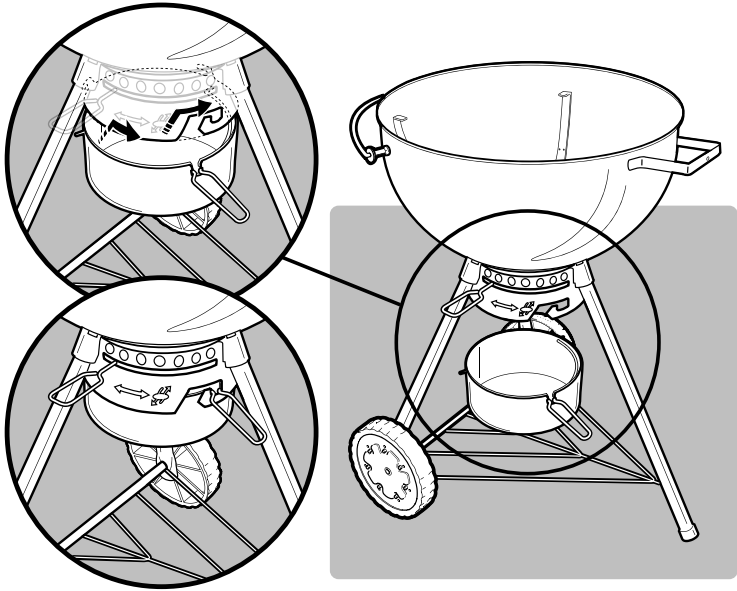

9

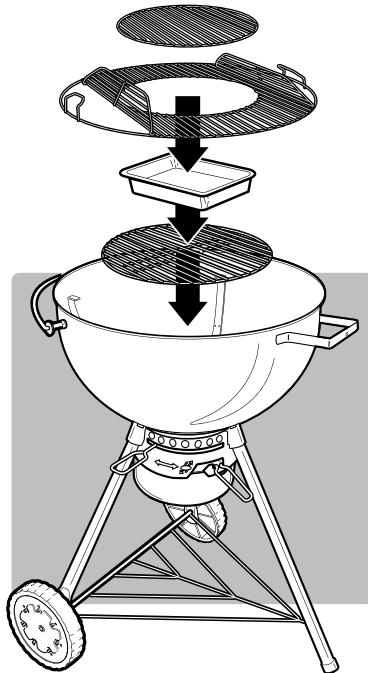

10

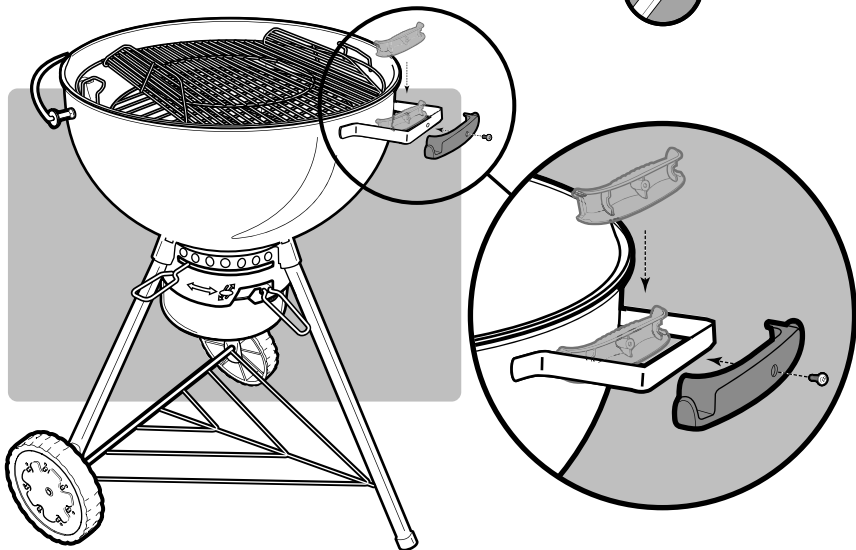
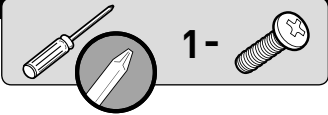

11

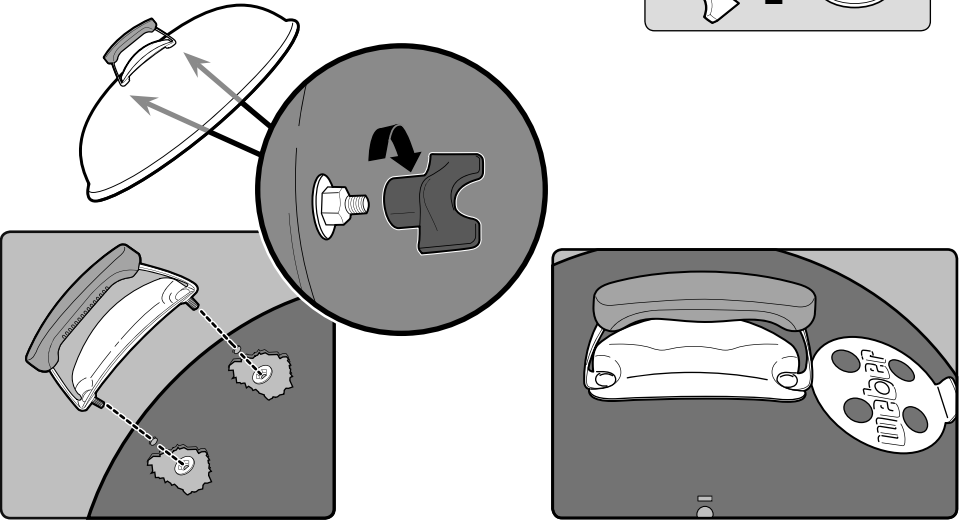

12

1- 

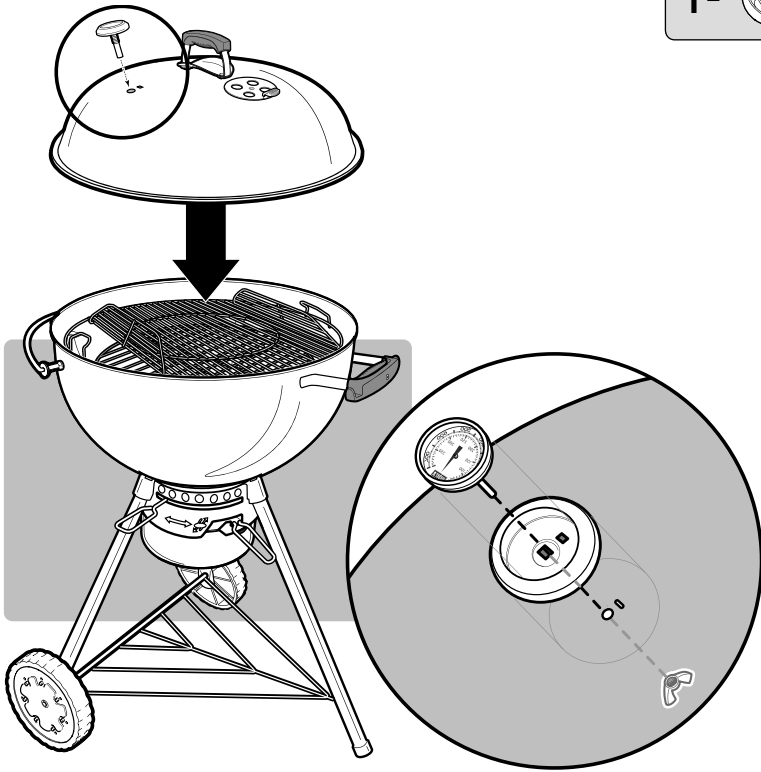

13

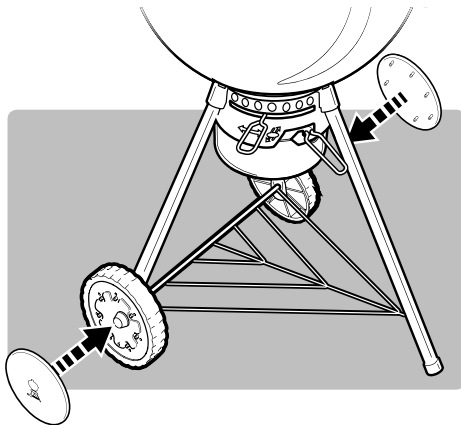

14

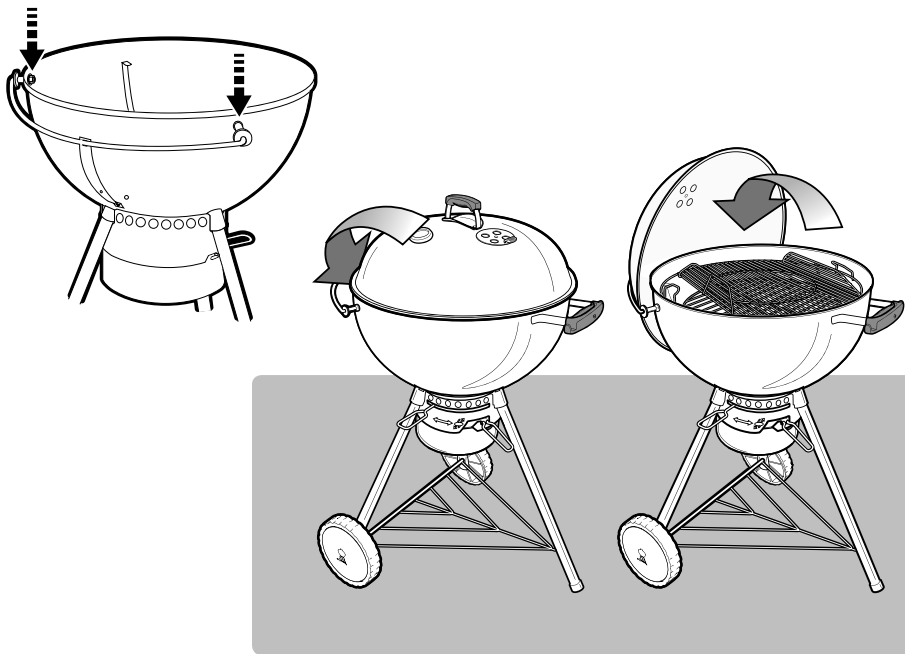

15

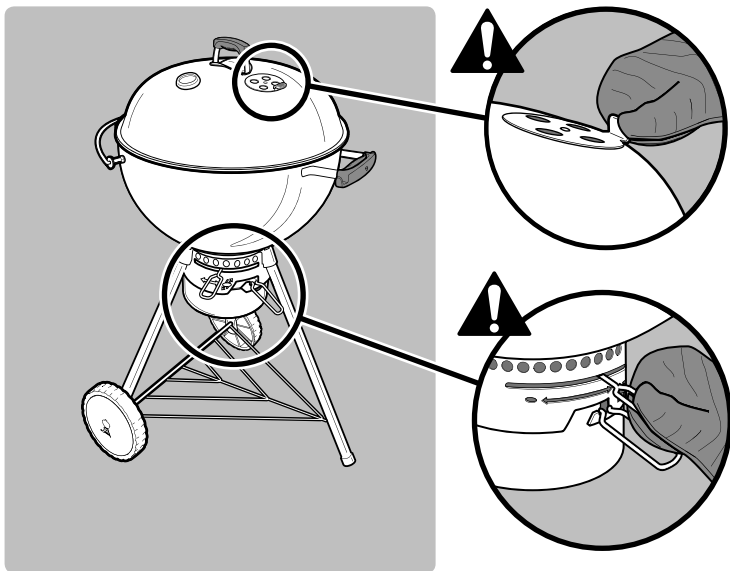

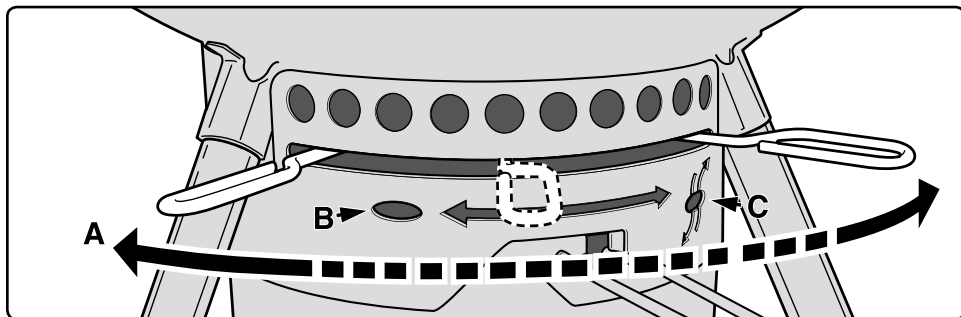

**EN** A - Clear ashes B - Vents closed C - Vents open

△ **WARNING:** When using liquid starters always check ash catcher before lighting. Fluid can collect in the ash catcher and could ignite, resulting in a fire below the bowl. Remove any starting fluid from the ash catcher before lighting charcoal.

**FI** A - Poista tuhka B - Ilmareiät suljettu C - Ilmareiät auki

△ **VAROITUS!** Sytytysnestettä käytettäessä tarkista aina tuhkaneruuastia ennen sytytystä. Nestettä voi kerääntyä tuhkaneruuastiaan ja se voi syttyä aiheuttaen tulen grillin alla. Poista mahdollinen sytytysneste tuhkaneräysastiasta ennen brikettien sytyttämistä.

**FR** A - Evacuation des cendres B - Clapets fermés C - Clapets ouverts

△ **AVERTISSEMENT:** Lorsque vous utilisez du liquide d'allumage, vérifiez toujours le cendrier avant d'allumer. Le liquide risque de s'écouler dans le cendrier et de s'y enflammer, provoquant ainsi un feu sous le foyer. Retirez tout fluide de démarrage de l'attrape-cendres avant d'allumer le charbon de bois.

**IT** A - Eliminare la cenere B - Prese d'aria chiuse C - Prese d'aria aperte

△ **AVVERTENZA:** quando si usano prodotti liquidi per accendere la carbonella, occorre controllare sempre il raccogli-cenere prima procedere. È possibile infatti che del fluido si raccolga nel raccogli-cenere e prenda fuoco causando un incendio sotto il barbecue. Prima di accendere il carbone, rimuovere eventuali liquidi accendifuoco dal raccogli-cenere.

**NO** A - Tøm aske B - Ventilert lukket C - Ventilert åpne.

△ **ADVARSEL:** Når tennvæske benyttes må askeoppsamler alltid sjekkes før tenning. Væske kan samle seg i askeoppsamleren og antennes, som resulterer i brann under kjelen. Fjern opp Tenningsvæske fra askeoppsamleren før brikettene tennes.

**DA** A - Fjern asken B - Spjældene lukkede C - Spjældene åbne

△ **ADVARSEL:** Når tændvæske bruges, må askebakken altid efterses før tænding. Væske kan samle sig i askebakken og antænde, så brand kan opstå nederen der kedlen. Fjern eventuel tændvæske fra askeskuffen, inden kullene antændes.

**ES** A - Eliminación de la ceniza B - Orificios cerrados C - Orificios abiertos

△ **ADVERTENCIA:** Si usa fluidos para encender el carbón, revise siempre el recogedor de cenizas antes de encender. El fluido que puede acumularse en el recogedor de cenizas podría inflamarse y provocar un incendio debajo de la olla. Elimine cualquier fluido de encendido en el recolector de cenizas antes de encender el carbón vegetal.

**SV** A - Tömmer askan B - Spjällen stängda C - Spjällen öppna

- △ **WARNING:** Om tändvätska används skall askfångaren alltid kontrolleras innan kolen tänds, eftersom tändvätska kan rinna ner i askfångaren, antändas och börja brinna under grillen. Avlägsna all tändvätska från askuppsamlaren innan grillbriketterna antänds.

**DE** A - Asche entfernen B - Belüftungsöffnungen geschlossen C - Belüftungsöffnungen offen

- △ **WARNHINWEIS:** Bei Verwendung von flüssigen Grillanzündern muß vor dem Anzünden stets der Aschenauffang geprüft werden. Selbst eine geringe Ansammlung von Zündflüssigkeit im Aschenauffang könnte sich entzünden und ein Feuer unter der Grillkugel verursachen. Achten Sie darauf, dass sich vor dem Anzünden der Holzkohle keine Brennlüssigkeit in der Ascheauffangschale befindet.

**NL** A - As opruimen B - Openingen gesloten C - Openingen open

- △ **WAARSCHUWING:** Controleer de asla altijd voordat u vloeibare aansteekvloeistof gebruikt. De vloeistof kan zich in de asla ophopen en kan ontsteken, hetgeen tot brand onder de barbecue kan leiden. Verwijder alle aanmaakvloeistof uit de asschaal voordat u de briketten aansteekt.

**PT** A - Limpe as cinzas B - Orifícios fechados C - Orifícios abertos

- △ **ATENÇÃO:** Quando estiver usando fluidos líquidos para acendimento, verifique antes o coletor de cinzas. O fluido pode ficar acumulado no coletor e provocar fogo embaixo do recipiente. Retire todos os fluidos de ignição do coletor de cinzas antes de acender o carvão.

**PL** A - Wysyp popiół B - Otwory wentylacyjne zamknięte C - Otwory wentylacyjne otwarte

- △ **OSTRZEŻENIE:** Jeśli używasz płynnej podpałki, zawsze przed rozpaleniem ognia sprawdź popielnik. W popielniku mógł zgromadzić się płyn, który może się zapalić. Usunąć płyn do rozpalania z popielnika przed rozpaleniem węgla.

**RU** A - Очистить золу B - Вентиляционные отверстия закрыты C - Вентиляционные отверстия открыты

- △ **ПРЕДУПРЕЖДЕНИЕ:** При использовании жидкостных зажигателей, всегда проверяйте золоуловитель перед розжигом. Жидкость может скапливаться в золоуловителе и может загореться, приводя к воспламенению под чашей гриля. Удалите любую жидкость от золоуловителя перед разжиганием древесного угля.

**UK** A - Вилучення золи B - Отвори закриті C - Отвори відкриті

- △ **ПОПЕРЕДЖЕННЯ:** При використанні рідин для розпалювання завжди перевіряйте золоуловлювач перед запалюванням. Рідина може накопичуватись в золоуловлювачі й запалитися, що спричинить пожежу під чашею. Вилучити рідину для запалювання з золоуловлювача перед розпаленням деревного вугілля.

**HU** A - Hamu eltávolítva B - Szellőzőnyílások bezárva C - Szellőzőnyílások nyitva

- △ **FIGYELMEZTETÉS:** A folyékony begyújtóanyagot használ, begyújtás előtt minden esetben ellenőrizze a hamufelfogó tálcát. A folyadék összegyűlhet a hamufelfogó tálcában és meggyulladhat, ami tűzhöz vezethet a teknő alatt. A faszén begyújtása előtt az összes begyújtófolyadékot távolítsa el a hamufelfogó tálcából.

**RO** A - Îndepărtarea cenuşii B - Aerisiri închise C - Aerisiri deschise

- △ **AVERTIZARE:** Dacă utilizați lichide de aprindere, verificați întotdeauna tava de cenușă înainte de a aprinde. Lichidul se poate colecta în tava de cenușă și se poate aprinde, generând o flacăra sub vasul grătarului. Înainte de a aprinde cărbunii, îndepărtați lichidul de aprindere din tava de cenușă.



BG

A – Изчистена пепел B – Затворени клапани C – Отворени клапани

⚠ **ПРЕДУПРЕЖДЕНИЕ:** Когато използвате течности за разпалване, винаги проверявайте пепелника преди запалване. Течността може да се събере в пепелника и да се възпламени, което да доведе до огън под купата. Отстранете запалителната течност от пепелника преди запалване на въглищата.

SL

A – Odstranite pepel B – Oddušniki zaprti C – Oddušniki odprti

⚠ **OPOZORILO:** Pri uporabi tekočih sredstev za vžig vedno preverite lovilnik pepela pred vžigom. Tekočina se lahko nabere v lovilniku pepela in se vžge ter povzroči požar v posodi. Preden prižgete oglje, odstranite vso tekočino za vžig iz lovilnika pepela.

SK

A – Odstráňte popol B – Vetracie otvory zatvorené C – Vetracie otvory otvorené

⚠ **VAROVANIE:** Pri použití tekutých zapaľovačov vždy pred zapálením skontrolujte zachytávač popola. Kvapalina sa môže nazbierať v zachytávači popola a vznietiť, čím spôsobí oheň pod miskou. Odstráňte zo zachytávača popola pred zapálením dreveného uhlia všetku zapaľovaciú tekutinu.

HR

A – očistite pepeo B – otvori za zrak su zatvoreni C – otvori za zrak su otvoreni

⚠ **UPOZORENJE:** Kad koristite tekućinu za paljenje uvijek prije paljenja provjerite posudu za prihvatanje pepela. Tekućina se može sakupljati u posudi za prihvatanje pepela i može se zapaliti, dovodeći do vatre ispod posude. Uklonite svu tekućinu za paljenje iz posude za prihvatanje pepela prije paljenja ugljena.

CS

A – Popel odstraněn B – Průduchy uzavřené C – Průduchy otevřené

⚠ **VAROVÁNÍ:** Při používání tekutých startérů vždy před zapálením nejprve zkontrolujte nádobu na popel. Tekutina se může v nádobě na popel shromažďovat, což může způsobit zapálení a následný požár pod kotlem. Před zapálením dřevěného uhlí vždy odstraňte veškerou startovací tekutinu z nádoby na popel.

IS

A – Hreinsa ösku B – Loftgöt lokuð C – Loftgöt opin

⚠ **VIÐVÖRUN:** Þegar notaður er kveikivökvi skal kannaður öskusafnarinn áður en kveikt er. Vökvi getur safnast í öskusafnarann, sem gæti kviknað í og orðið að báli undir grillbotninum. Fjarlægja skal allan kveikivökva úr öskusafnarannum áður en kveikt er í viðarkolunum.

TR

A – Küllerli temizleyin B – Havalandırma kanalları kapalı C – Havalandırma kanalları açık

⚠ **UYARI:** Tutuşturma sivilari kullanilacaksa, yakmadan önce kül tutucuyu kontrol edin. Bu sıvi, kül tutucuda birikebilir ve tutuşarak barbekünün atında ateş çıkartabilir. Kömürü yakmadan önce, varsa kül tutucudaki tutuşturma sivilarını temizleyin.

EL

A – Καθαρή στάχτη B – Οπές αερισμού κλειστές C – Οπές αερισμού ανοιχτές

⚠ **ΠΡΟΕΙΔΟΠΟΙΗΣΗ:** Όταν χρησιμοποιείτε υγρούς αναπτήρες ελέγχετε πάντα τον συλλέκτη στάχτης πριν από την έναυση. Μπορεί να συγκεντρωθεί υγρό στο συλλέκτη στάχτης και να αναφλεγεί με αποτέλεσμα φωτιά κάτω από τη λεκάνη. Απομακρύνετε οποιοδήποτε είδους υγρό αναπτήρα από τον συλλέκτη στάχτης πριν ανάψετε τα κάρβουνα.







WEBER-STEPHEN PRODUCTS LLC

[www.weber.com](http://www.weber.com)<sup>®</sup>

© 2012 Designed and engineered by Weber-Stephen Products LLC,  
a Delaware limited liability company, located at 200 East Daniels Road, Palatine, Illinois 60067 U.S.A.  
*Printed in U.S.A.*

© 2012 Conception et développement par Weber-Stephen Products LLC,  
société du Delaware à responsabilité limitée dont le siège se trouve à l'adresse suivante :  
200 East Daniels Road, Palatine, Illinois 60067 États-Unis  
*Imprimé aux États-Unis.*

© 2012 Entwickelt und hergestellt von Weber-Stephen Products LLC,  
eine Gesellschaft mit beschränkter Haftung aus Delaware, Sitz in 200 East Daniels Road,  
Palatine, Illinois 60067 USA.  
*Gedruckt in den USA.*