

Technische Daten Trondheim 70-M

Wandaußenmaß: 500 x 400 cm

Bohlenstärke: 70 mm



Kontrolliert durch:

Empty rectangular box for signature or stamp.

Achtung: Alle angegebenen Maße sind ca.-Maße!

3D-Darstellung und Grundriss Trondheim 70-M

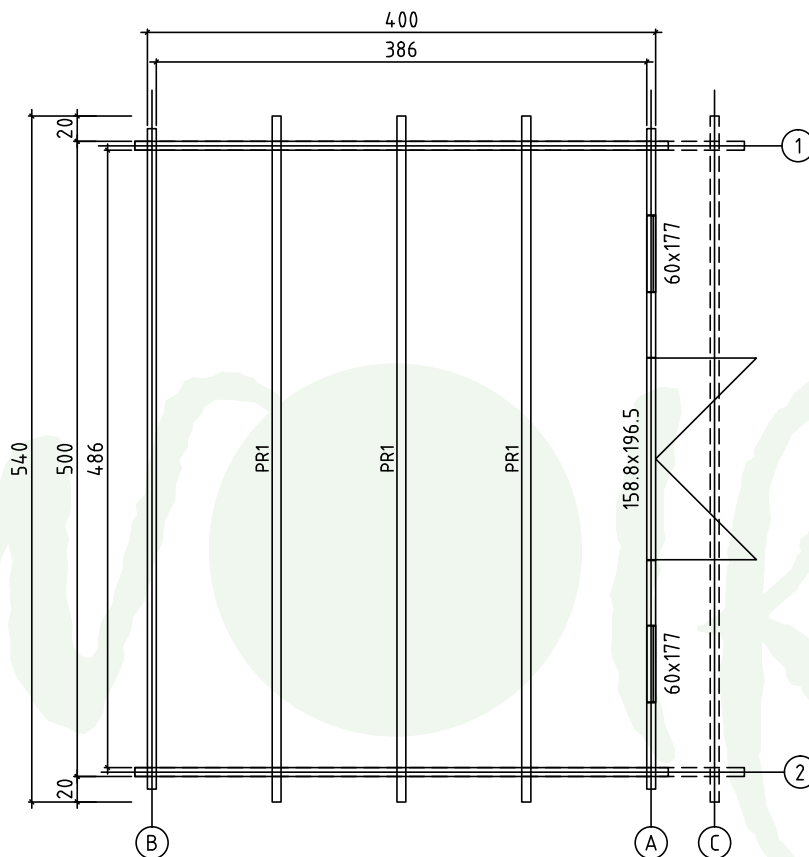
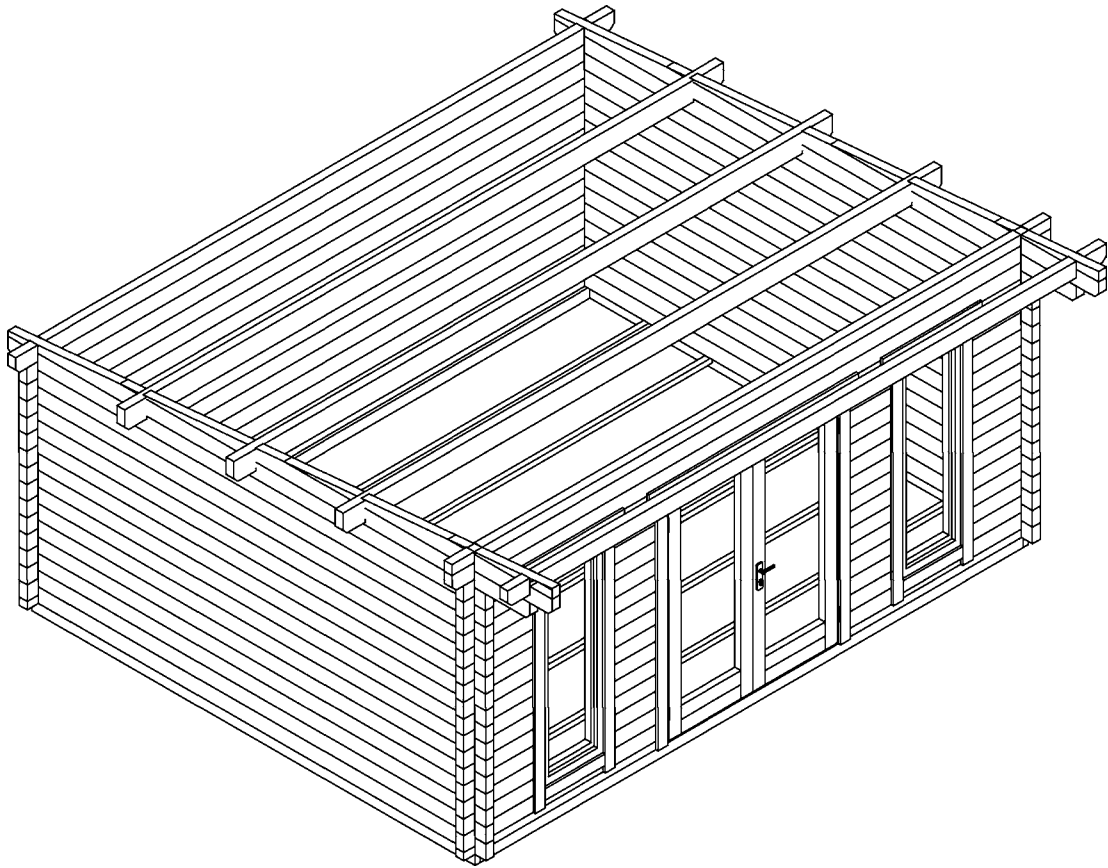

Lagerholzplan und Fundamentplan Trondheim 70-M

Wir empfehlen als Fundament für Ihr Gartenhaus eine vollflächig,
festgegründete gepflasterte oder betonierte Fläche.
Wahlweise ist auch ein Punkt- oder Streifenfundament möglich.

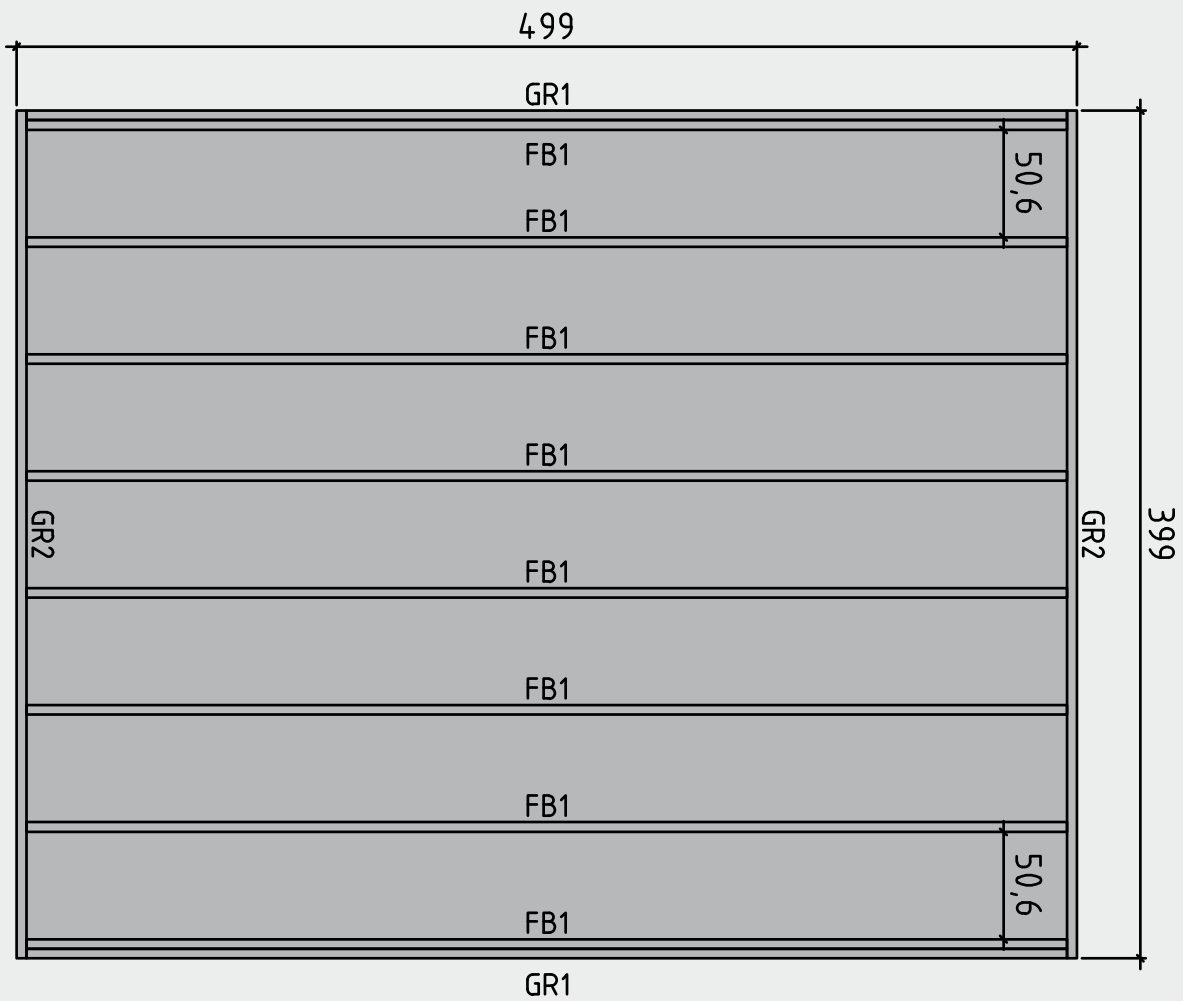











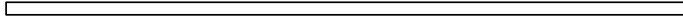
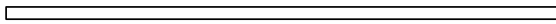

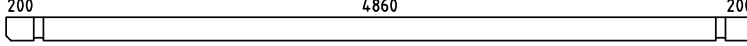
Teileliste 1

Trondheim 70-M

| Pos | Quantity | Profil (mm) | Lenght (mm) |
|-----|----------|-------------|-------------|
| 001 | 2 | 70x130 | 4200 |
| 002 | 2 | 70x130 | 4200 |
| 003 | 24 | 70x130 | 4200 |
| 004 | 2 | 70x130 | 4300 |
| 005 | 2 | 70x130 | 1188 |
| 006 | 2 | 70x130 | 3053 |
| 007 | 2 | 70x16 | 179 |
| 008 | 2 | 70x102 | 952 |
| 009 | 2 | 70x130 | 2470 |
| 010 | 2 | 70x59 | 668 |
| 011 | 2 | 70x130 | 1717 |
| 012 | 2 | 70x83 | 938 |
| 013 | 2 | 70x65 | 1801 |
| 014 | 1 | 70x130 | 1801 |
| 015 | 1 | 70x130 | 1801 |
| 016 | 28 | 70x130 | 681 |
| 017 | 28 | 70x130 | 510 |
| 018 | 1 | 70x130 | 5200 |
| 019 | 1 | 70x130 | 5400 |
| 020 | 1 | 70x86 | 5400 |
| 021 | 1 | 70x65 | 5200 |
| 022 | 1 | 70x130 | 5200 |
| 023 | 13 | 70x130 | 5200 |
| 024 | 1 | 70x130 | 5400 |
| 025 | 1 | 70x130 | 5400 |

Teileliste 2

Trondheim 70-M

| Pos | | Quantity | Profil (mm) | Lenght (mm) |
|-----|---|----------|-------------|-------------|
| GR1 | Rahmen-Fundamentholz  | 2 | 45x90 | 4900 |
| GR2 | Rahmen-Fundamentholz  | 2 | 45x90 | 3990 |
| FB1 | Fundamentholz  | 8 | 45x90 | 4900 |
| PR1 | Pfetten 4860 200  200 | 3 | 70x170 | 5400 |
| | Fenster 600x1770 | 2 | | |
| | Tür 1588x1965 | 1 | | |
| 1 | Screws/Schrauben/Vis 5x100 mm- For fixing first row of wall logs /Fixierung des ersten Bohlenkranzes/Pour fixer les lamesde plancher  | 6 | | |
| 2 | Nails/Nägel/Clous 2.5x50 - For fixing floorboards/ Befestigung Fussbodenbretter/Pour fixer les lames de plancher  | 450 | | |
| 3 | Nails/Nägel/Clous 2.5x50 - For fixing roofboards/ Befestigung Dachbretter/Pour fixer les voliges  | 400 | | |
| 4 | Nails/Nägel/Clous 2.5x50 - For fixing floor edge trims/ Befestigung Fussleisten/Pour fixer les plinthes du plancher  | 40 | | |
| 5 | Nails/Nägel/Clous 2.5x50 - For fixing roofing felt fillet/ Befestigung giebelabschlussbrett/Pour fixer la latte de finition de la couverture  | 40 | | |
| 6 | Screws/Schrauben/Vis 2,5x50 mm- For fixing roof side boards and roof edge reinforcement Befestigung Traufenbretter und Traufenleisten Pour fixer les planches de rive et le tasseau de refront  | 150 | | |
| 7 | Screws/Schrauben/Vis 2,5x50 mm- For fixing fascia boards and diamonds/ Befestigung Giebelblende und Raute Pour fixer les planches de rive et le diamant  | | | |
| 8 | Screws/Schrauben/Vis 2,5x50 mm- For fixing fwindow and door trims/ Befestigung Fenster und türen/ Pour fixer les croisillons des fenetres et des portes  | | | |
| 9 | Metal storm Brace/Gewindestange/Tige filetee 10 mm  | 5 | | |
| 10 | Shim/Nuts/Mutter ,U-Scheibe/Ecrou;Rondelle 10 mm For fixing storm braces/ Pour fixer les anti tempete/ Für Sturmleisten Pour fixer les croisillons des fenetres et des portes  Metal storm Brace/Gewindestange/Tige filetee 10 mm KL1 M10 2,18 m 2 Screws 180 10 pcs. KL2 M10 2,12 m 1 Plastic caps 5 pcs. KL3 M10 2,46 m 2 | 5/5 | | |

Teileliste 3

Trondheim 70-M

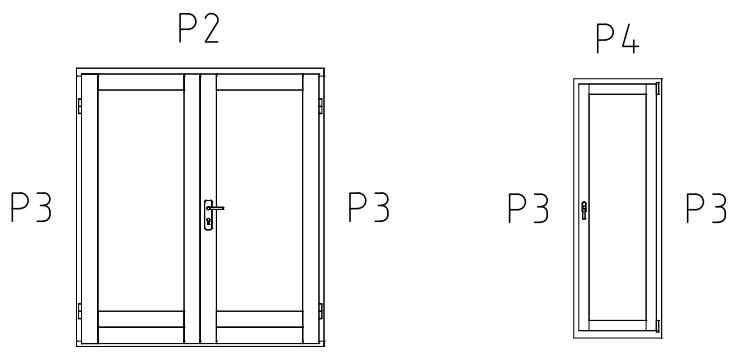
| POS | ST. | B | H | L | |
|------------|--------------------|-------------|--------------|-----------------------|--|
| FB1 | Vt. spetsi | | | | FUNDMENTHOLZER |
| F1 | 18,8m ² | 28 | | 3855 | FUSSBODENBRETTER |
| PR | 3 | 70 | 170 | 5400 | DACHBALKEN |
| RB1 | 26,6m ² | 20 | | 4919 | DACHBRETTER |
| R1 | 2 | 20 | 140 | 5440 | Traufenbretter |
| R2 | 2 | 45 | 65 | 5400 | Traufenbretter |
| R3 | 2 | 20 | 140 | 5120 | Giebelabschlussleiste |
| R4 | 2 | 20 | 90 | 5120 | Giebelabschlussleiste |
| DR1 WN1 | 1 2 | 1588 600 | 1965 1770 | |  <p>Schiebelamellen 30x30x1900 mm - 2 Stk. Schiebelamellen 30x30x1720 mm - 4 Stk.</p> |
| P1 | 19m | 20 | 40 | | Fussbodenleiste |
| P2 | 1+1 | 20 | 90 | 1890 | Türleiste DR1 |
| P3 | 6+6 | 20 | 90 | 1945 | Türleiste DR1, Fensterleiste WN1 |
| P4 | 2+2 | 20 | 90 | 900 | Fensterleiste WN1 |
| P5 | 2+2 | 20 | 90 | 540 570 | Fensterleiste WN1 |



Detailzeichnungen Trondheim 70-M

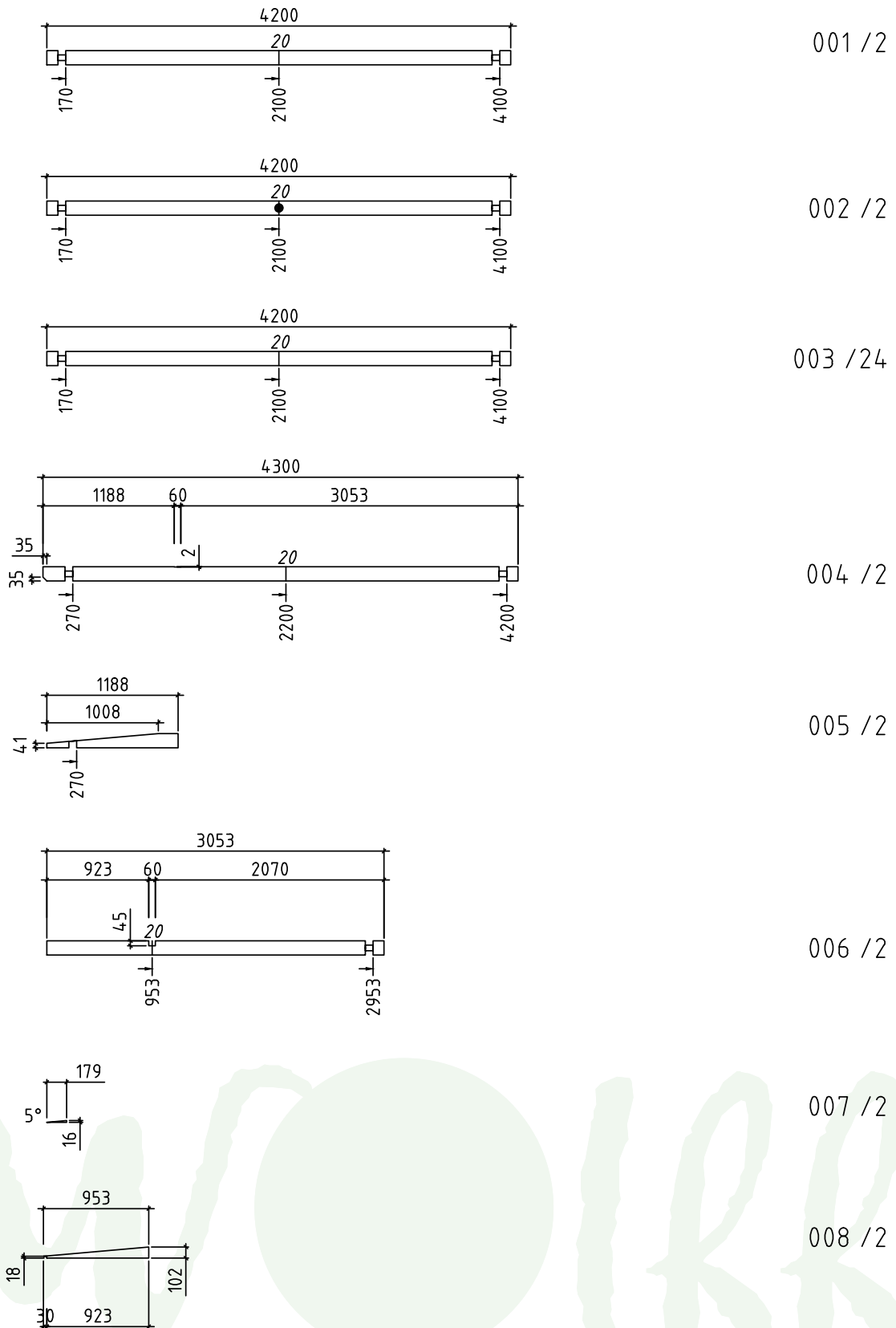

Detailzeichnungen Trondheim 70-M

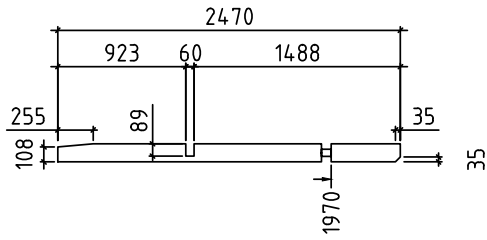

009 / 2

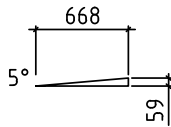

010 / 2

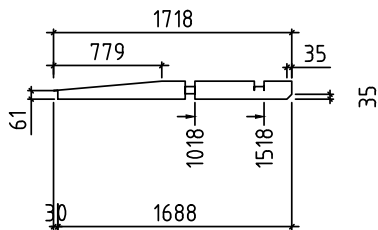

011 / 2

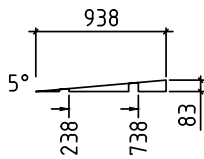

012 / 2

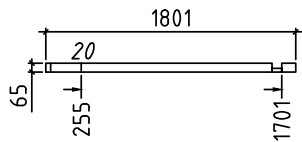

013 / 2

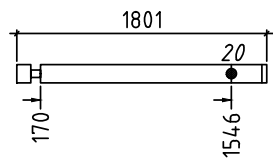

014 / 1

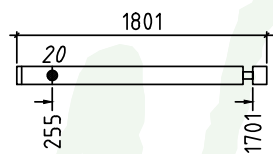

015 / 1

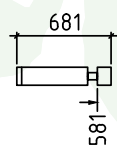

016 / 28

Detailzeichnungen Trondheim 70-M

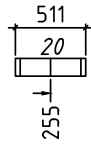

017 / 28

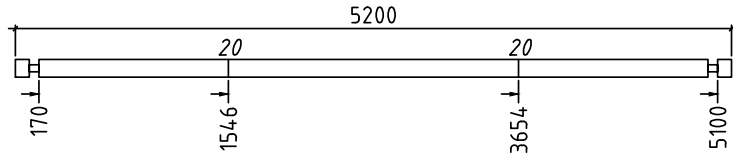

018 / 1

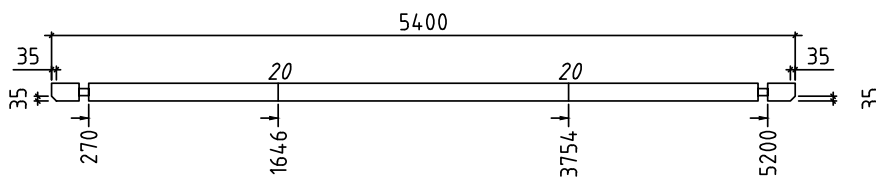

019 / 1

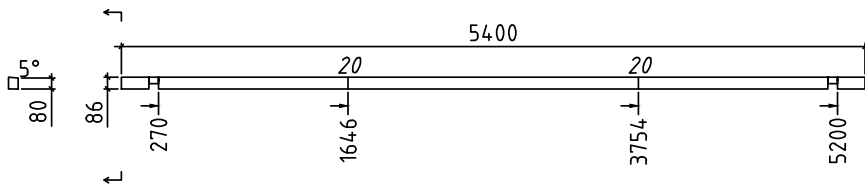

020 / 1

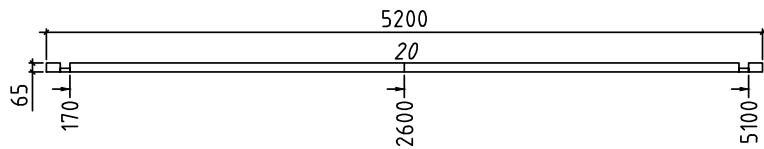

021 / 1

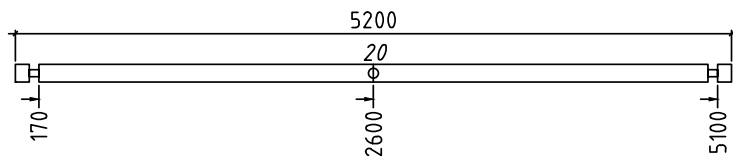

022 / 1

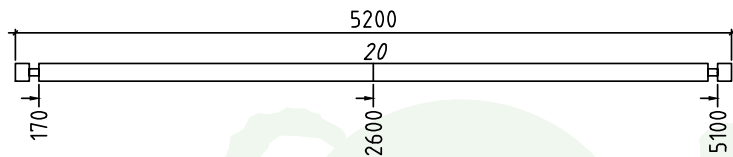

023 / 13

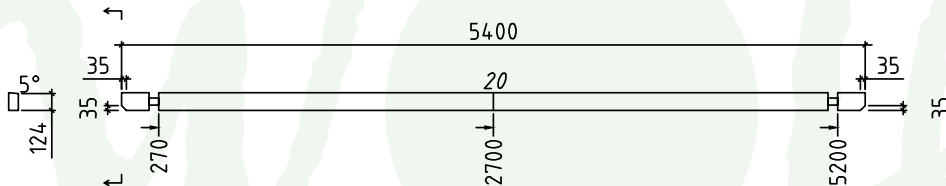

024 / 1

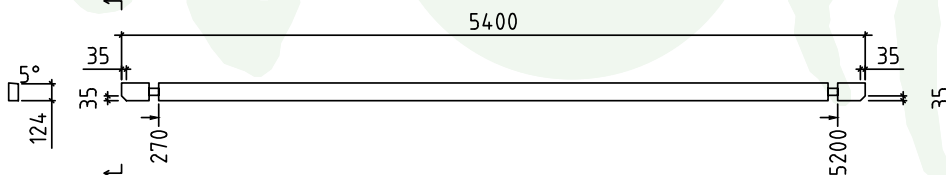

025 / 1

Detailzeichnungen Trondheim 70-M

Rahmen-Fundamentholz

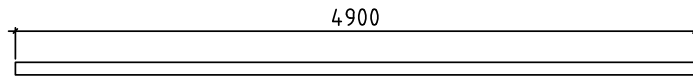

GR1 / 2
45x90

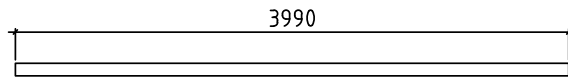

GR2 / 2
45x90

Fundamentholz

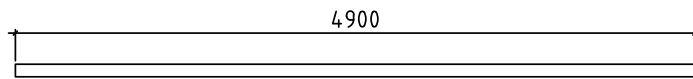

FB1 / 8
45x90

Pfetten

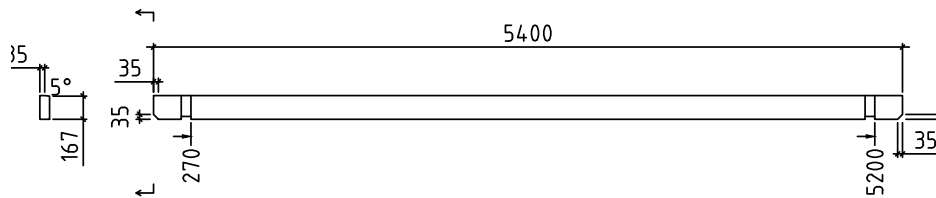

PR1 / 3
70x170(60x150)

Wandplan 1 und 2 Trondheim 70-M

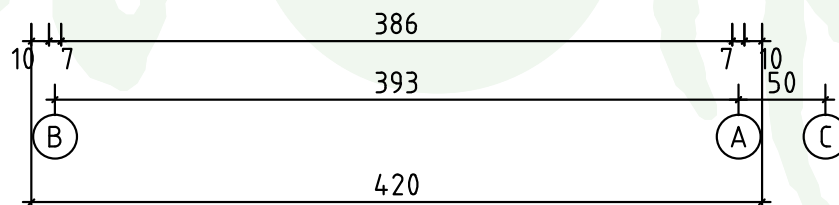
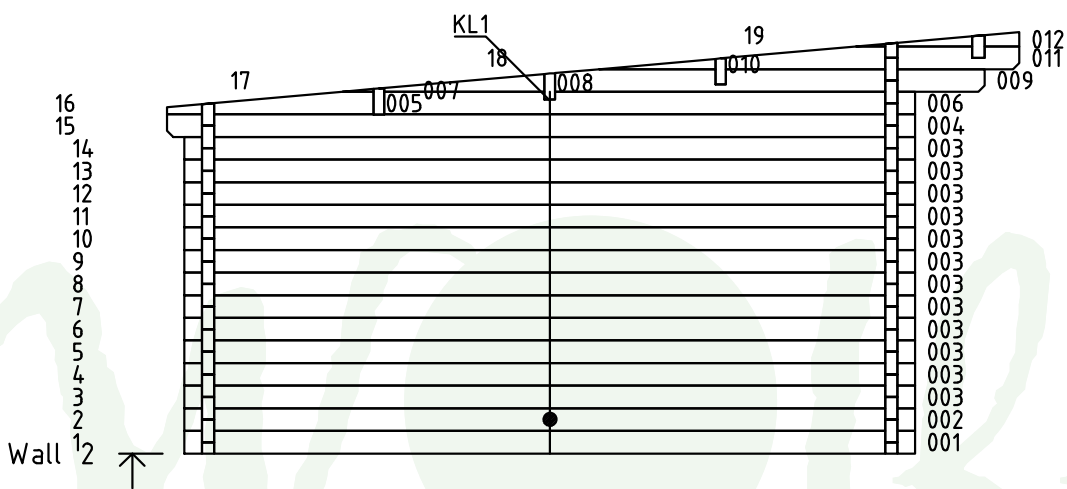
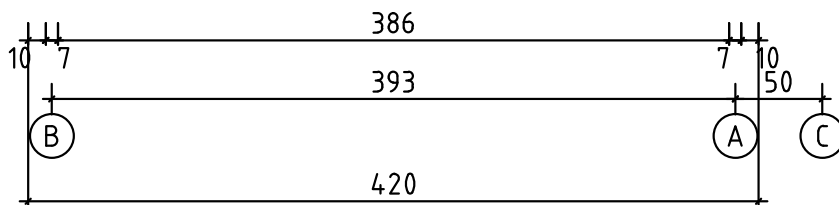
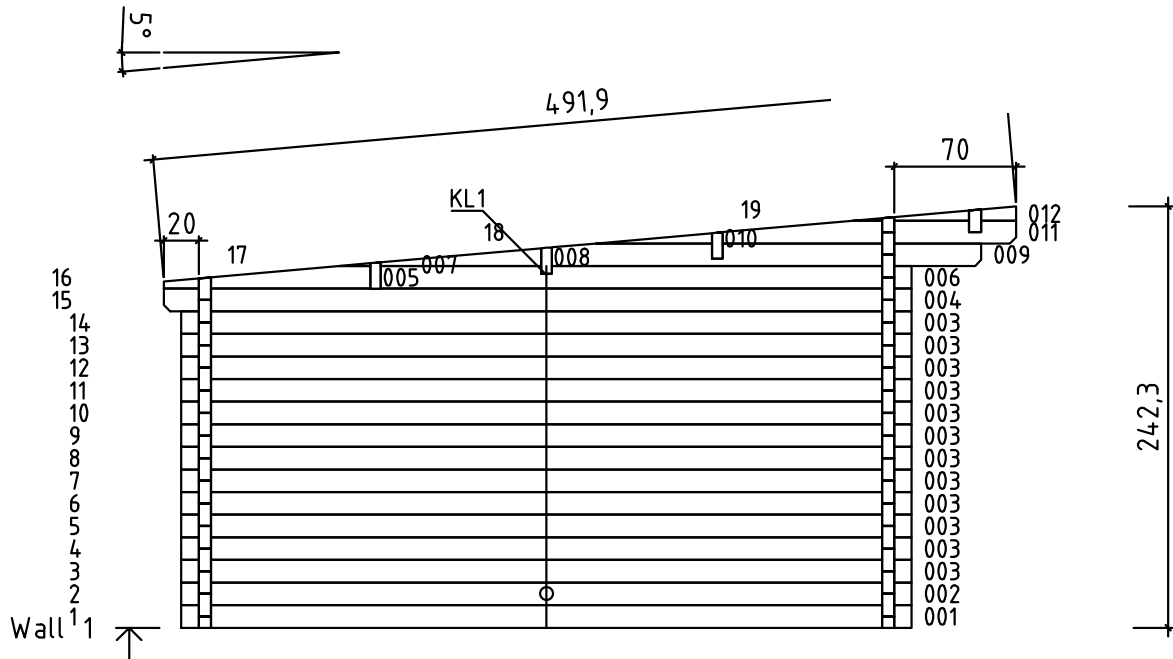

Wandplan A und B Trondheim 70-M

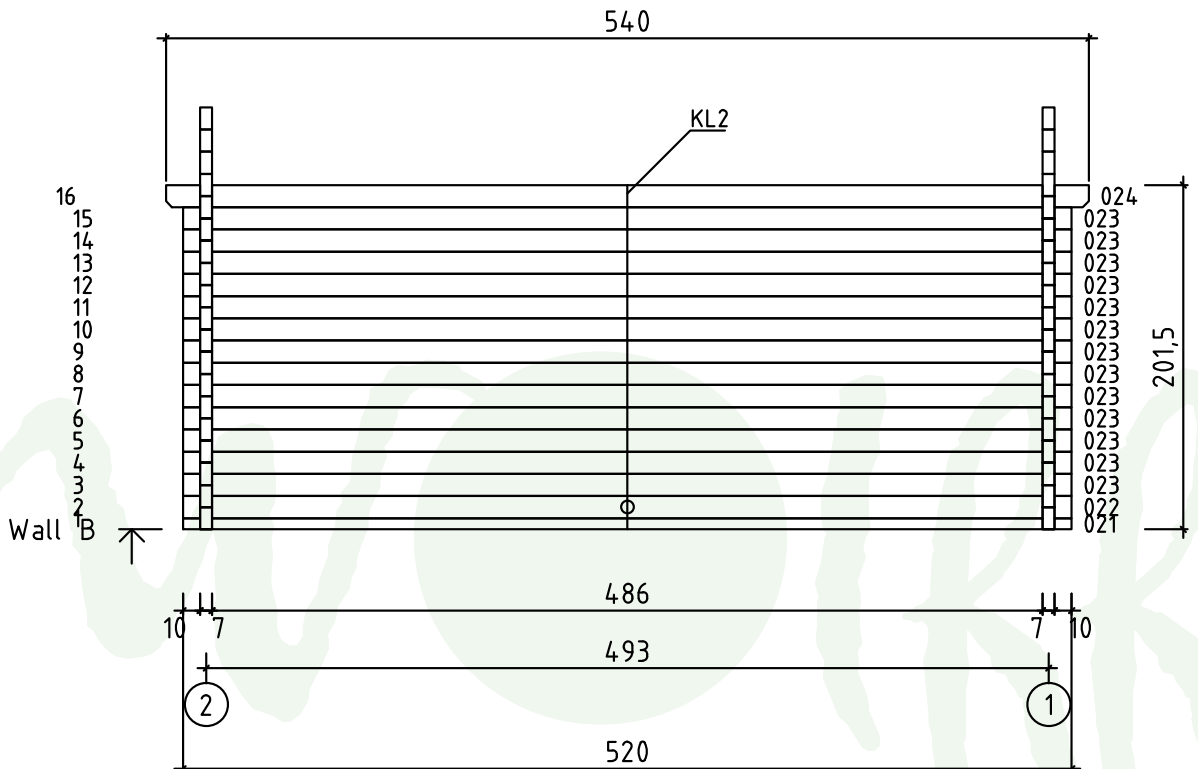
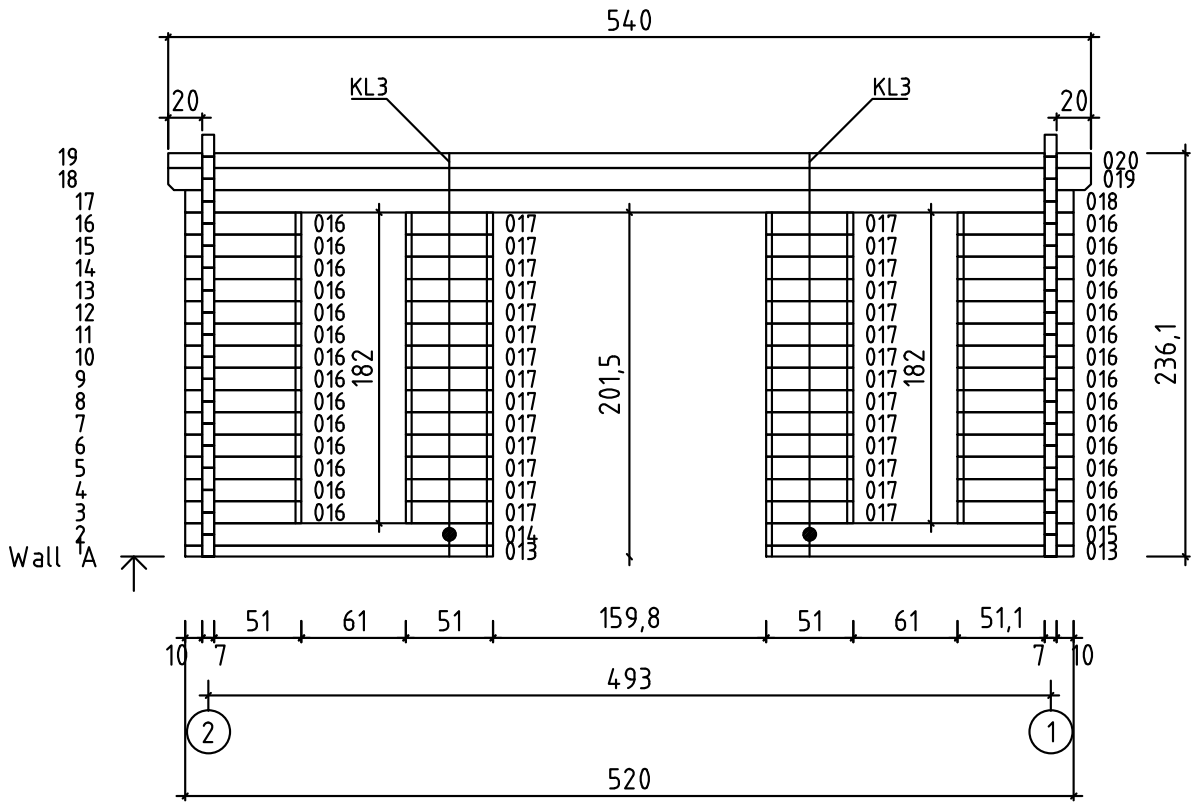

Wandplan C Trondheim 70-M

