

# Technische Daten Trondheim 70-C XL

Wandaußenmaß: 390 x 390 cm

Bohlenstärke: 70 mm



Kontrolliert durch:

Achtung: Alle angegebenen Maße sind ca.-Maße!

# 3D-Darstellung und Grundriss Trondheim 70-C XL

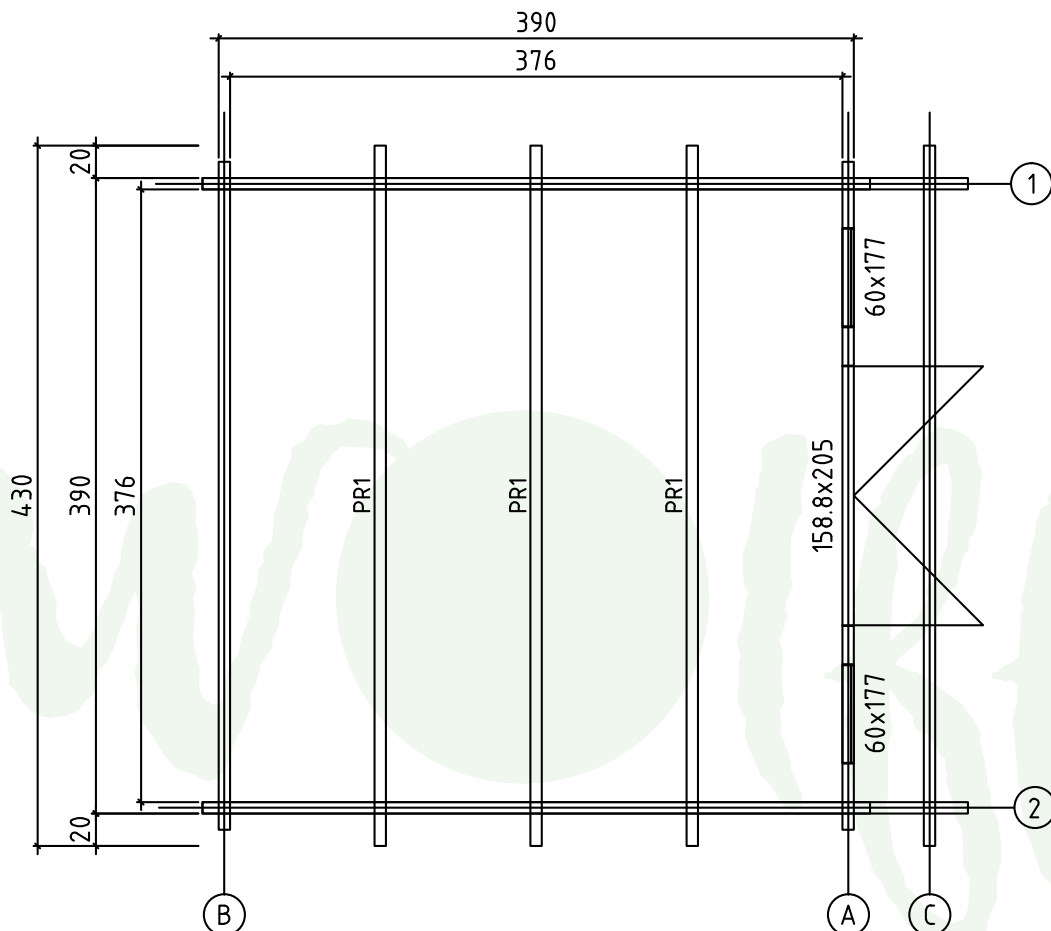
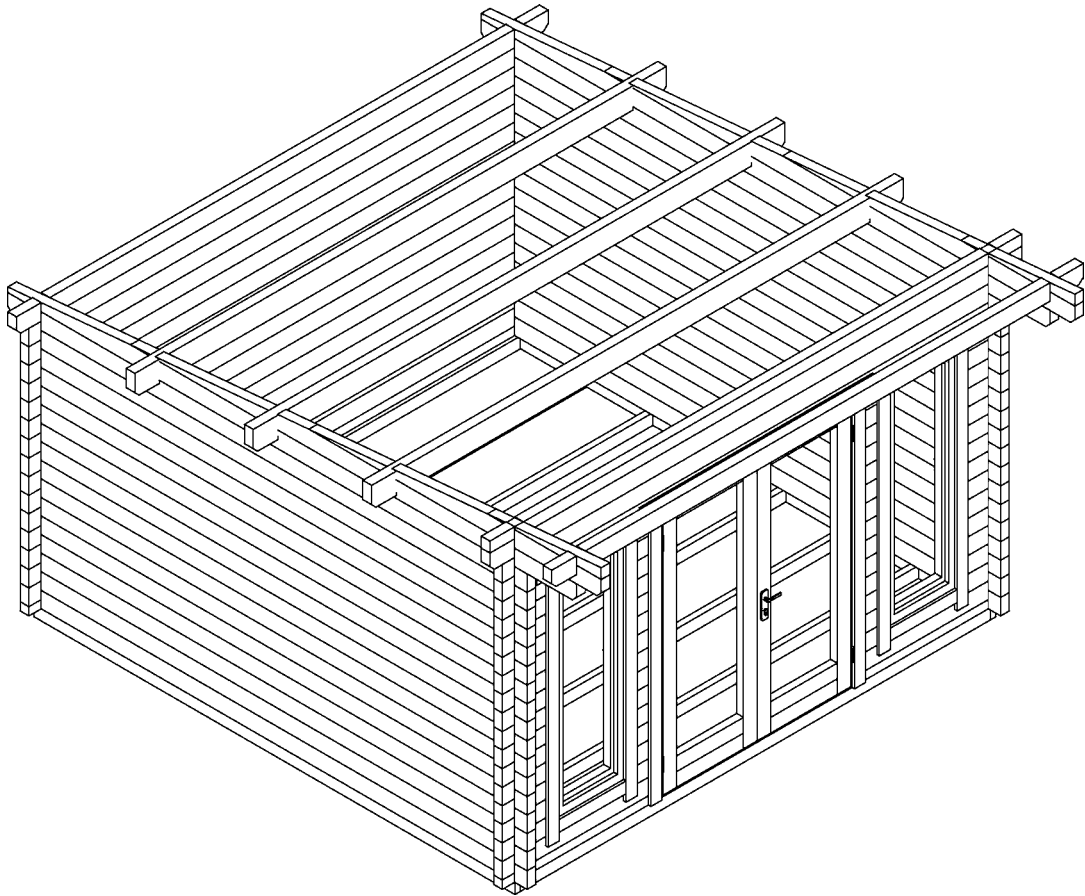





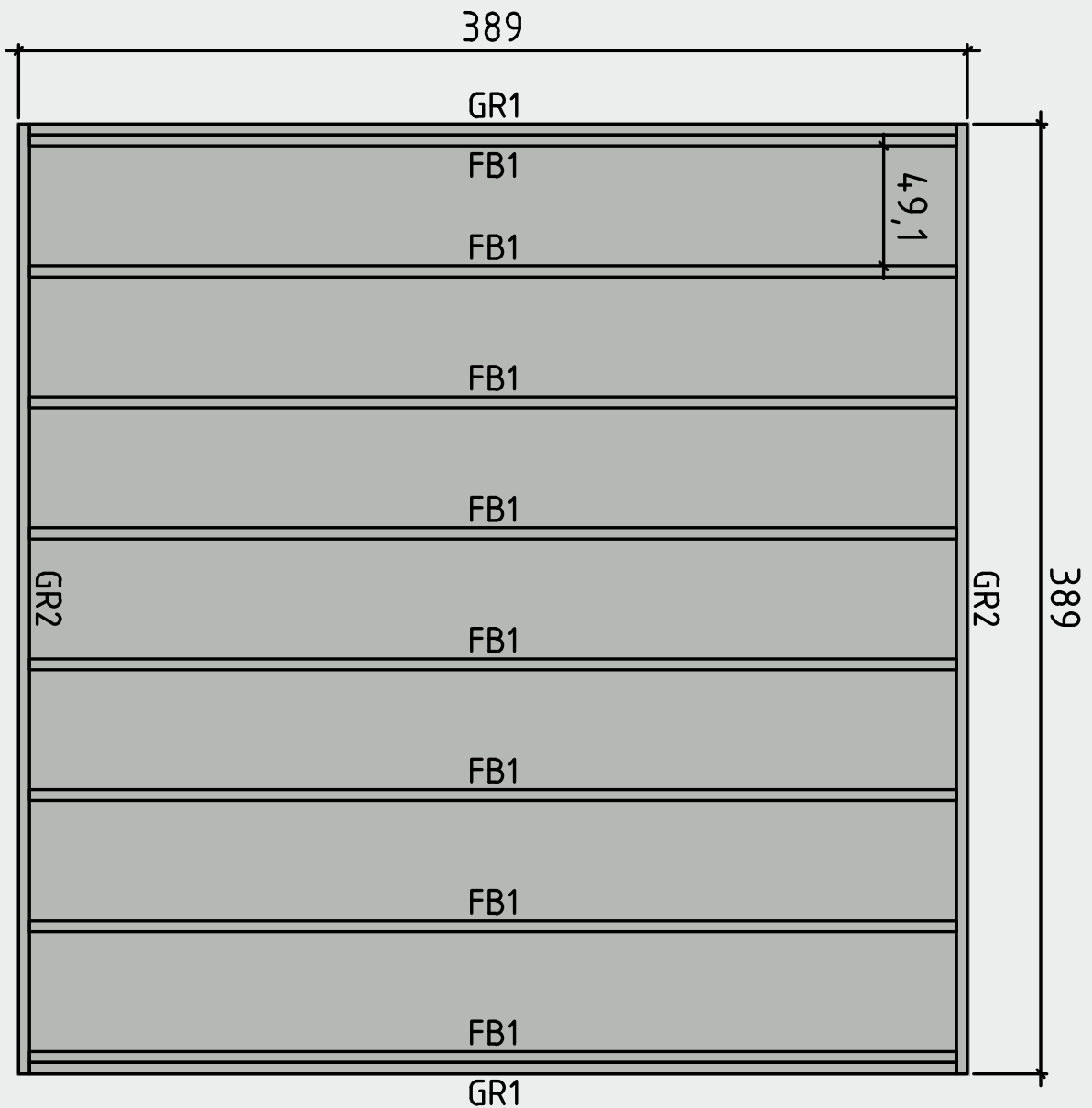

# Lagerholzplan und Fundamentplan Trondheim 70-C XL

Wir empfehlen als Fundament für Ihr Gartenhaus eine vollflächig,  
festgegründete gepflasterte oder betonierte Fläche.  
Wahlweise ist auch ein Punkt- oder Streifenfundament möglich.

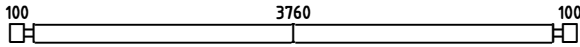
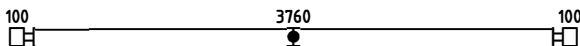
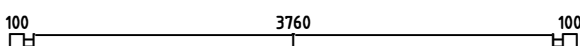
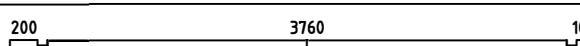
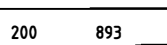
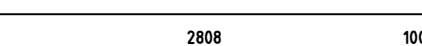

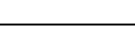
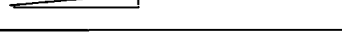

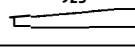
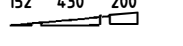
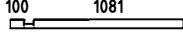
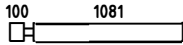

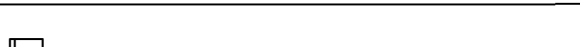
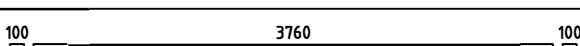
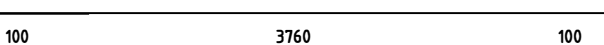
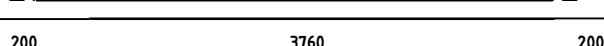
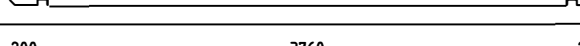
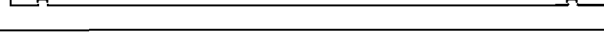
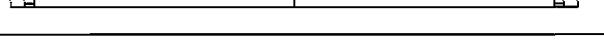
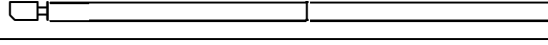

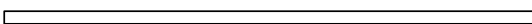
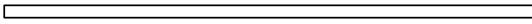
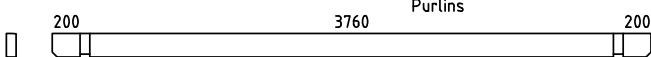

# Teileliste 1

## Trondheim 70-C XL

Pos			Profil (mm)	Lenght (mm)
001		2	70x130	4100
002		3	70x130	4100
003		40	70x130	4100
004		2	70x130	4200
005		2	70x130	1163
006		2	70x130	2978
007		2	70x15	171
008		2	70x102	928
009		2	70x130	2420
010		2	70x58	643
011		2	70x130	1693
012		2	70x83	922
013		2	70x65	1251
014		2	70x130	1251
015		2	70x130	1251
016		26	70x130	406
017		26	70x130	235
018		1	70x130	4100
019		1	70x130	4100
020		1	70x130	4300
021		1	70x85	4300
022		1	70x65	4100
023		1	70x130	4300
024		1	70x130	4300
GR2	GROUNDFRAME 	2	45x90	3890

# Teileliste 2

## Trondheim 70-C XL

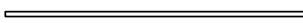
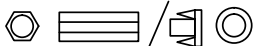
Pos			Profil (mm)	Lenght (mm)
GR1	GROUNDFRAME		45x90	3800
FB1	FLOORBEAMS		45x90	3800
PR1	Purlins		70x170	4300
70mm A-5	WINDOW 600x1770			
Wolf 70 m Double Door 1 H	DOOR 1588x2050			
1	Screws/Schrauben/Vis 5x100 mm- For fixing first row of wall logs /Fixierung des ersten Bohlenkranzes/Pour fixer les lames de plancher			6
2	Nails/Nägel/Clous 2.5x50 - For fixing floorboards/ Befestigung Fussbodenbretter/Pour fixer les lames de plancher			350
3	Nails/Nägel/Clous 2.5x50 - For fixing roofboards/ Befestigung Dachbretter/Pour fixer les voliges			300
4	Nails/Nägel/Clous 2.5x50 - For fixing floor edge trims/ Befestigung Fussleisten/Pour fixer les plinthes du plancher			30
5	Nails/Nägel/Clous 2.5x50 - For fixing roofing felt fillet/ Befestigung giebelabschlussbrett/Pour fixer la latte de finition de la couverture			30
6	Screws/Schrauben/Vis 2,5x50 mm- For fixing roof side boards and roof edge reinforcement Befestigung Traufenbretter und Traufenleisten Pour fixer les planches de rive et le tasseau de refront			150
7	Screws/Schrauben/Vis 2,5x50 mm- For fixing fascia boards and diamonds/ Befestigung Giebelblende und Raute Pour fixer les planches de rive et le diamant			
8	Screws/Schrauben/Vis 2,5x50 mm- For fixing fwindow and door trims/ Befestigung Fenster und türen/ Pour fixer les croisillons des fenetres et des portes			
9	Metal storm Brace/Gewindestange/Tige filetee 10 mm			3
10	Shim,Nuts/Mutter ,U-Scheibe/Ecrou;Rondelle 10 mm For fixing storm braces/ Pour fixer les anti tempete/ Für Sturmleisten Pour fixer les croisillons des fenetres et des portes Metal storm Brace/Gewindestange/Tige filetee 10 mm KL1 M10 2,18 m 2 Screws 180 6 pcs. KL2 M10 2,12 m 1 Plastic caps 3 pcs.		3/3	

# Teileliste 3

## Trondheim 70-C XL

POS	ST.	B	H	L	Teileliste
FB1	Vt. spetsi				FUNDMENTHOLZER
F1	14,1m <sup>2</sup>	28		3755	FUSSBODENBRETTER
PR	3	70	170	4300	DACHBALKEN
RB1	20,7m <sup>2</sup>	20		4819	DACHBRETTER
R1	2	20	140	4340	<small>Vaata katuse kalcenurka</small> Traufenbretter
R2	2	45	65	4300	<small>Vaata katuse kalcenurka</small> Traufenbretter
R3	2	20	140	5020	<small>Vaata katuse kalcenurka</small> Giebelabschlussleiste
R4	2	20	90	5020	Giebelabschlussleiste
WN06	2	600	1770		<p style="text-align: center;">Sliding slats 30x30x1600 mm - 4 pcs.</p>
DR16	1	1588	2050		
P1	16m	20	40		Fussbodenleiste
P2	4+4	20	90	1920	Fensterleiste WN 06
P3	2+2	20	90	900	Fensterleiste WN 06
P4	2+2	20	90	<del>540</del> 570	Fensterleiste WN 06
P5	2+2	20	90	2030	Türleiste DR 16
P6	1+1	20	90	1890	Türleiste DR 16



# Detailzeichnungen Trondheim 70-C XL

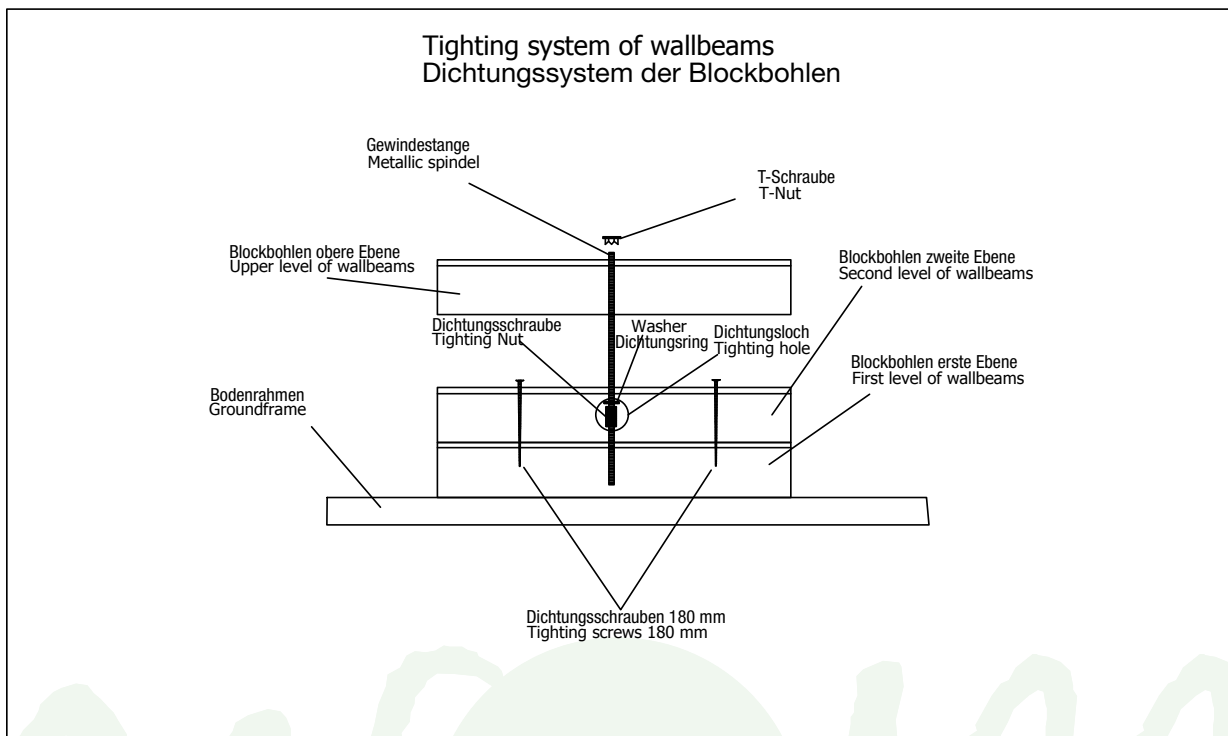
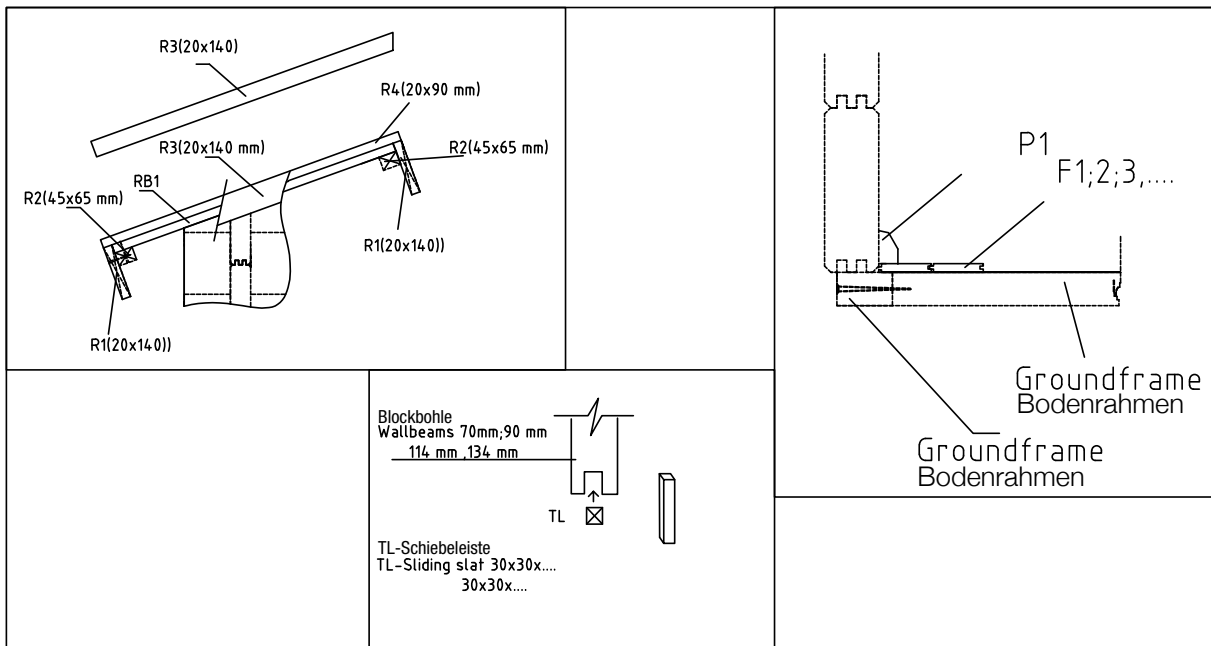

# Wandplan 1 und 2 Trondheim 70-C XL

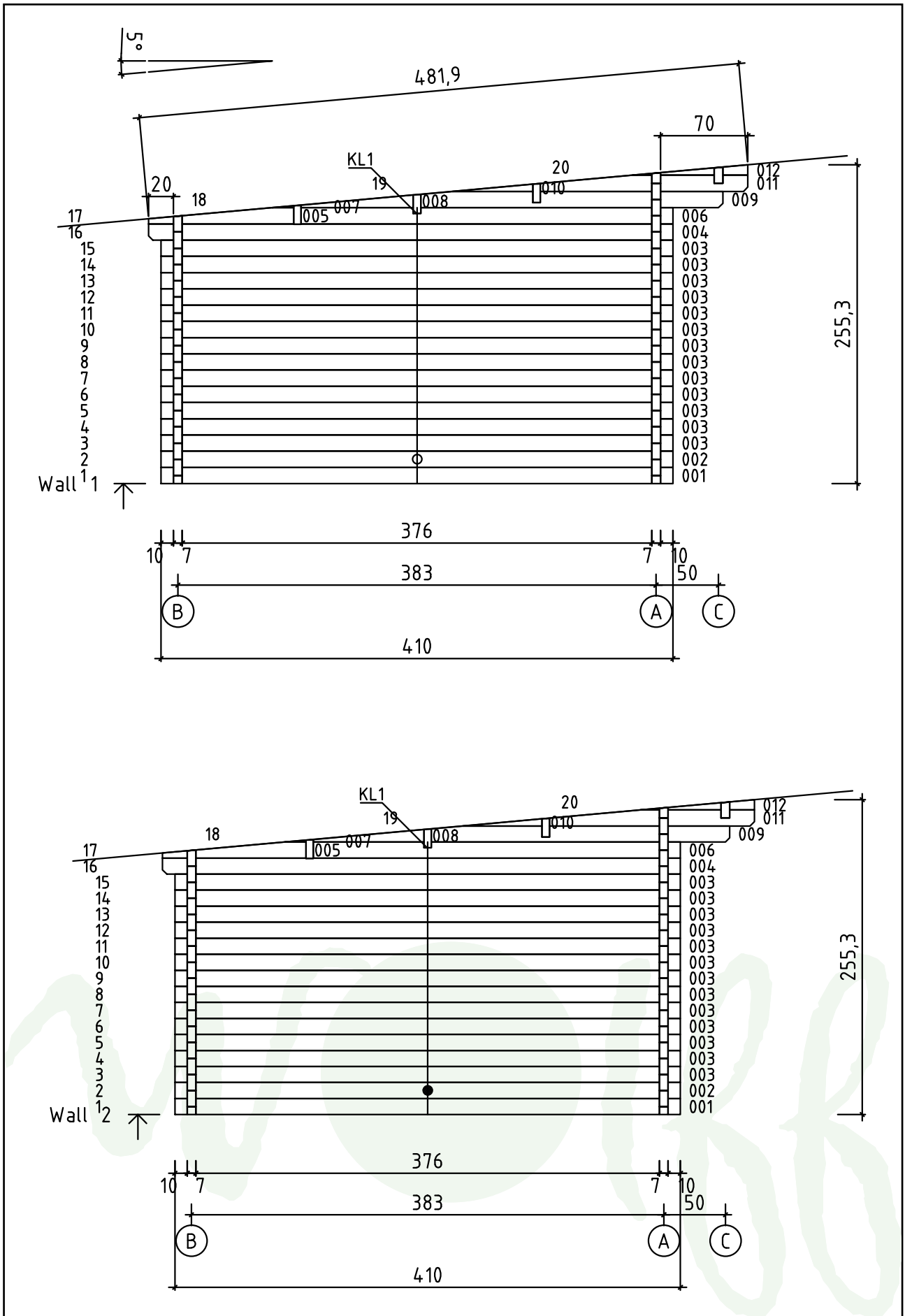



# Wandplan A und B Trondheim 70-C XL

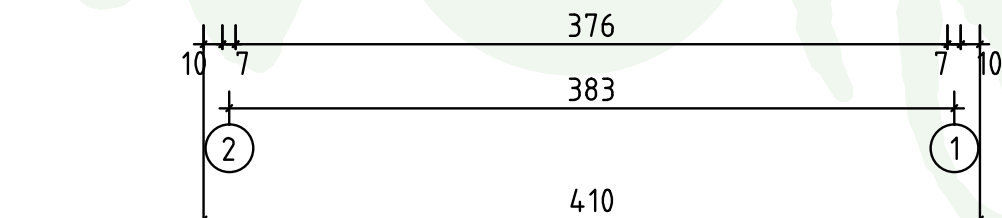
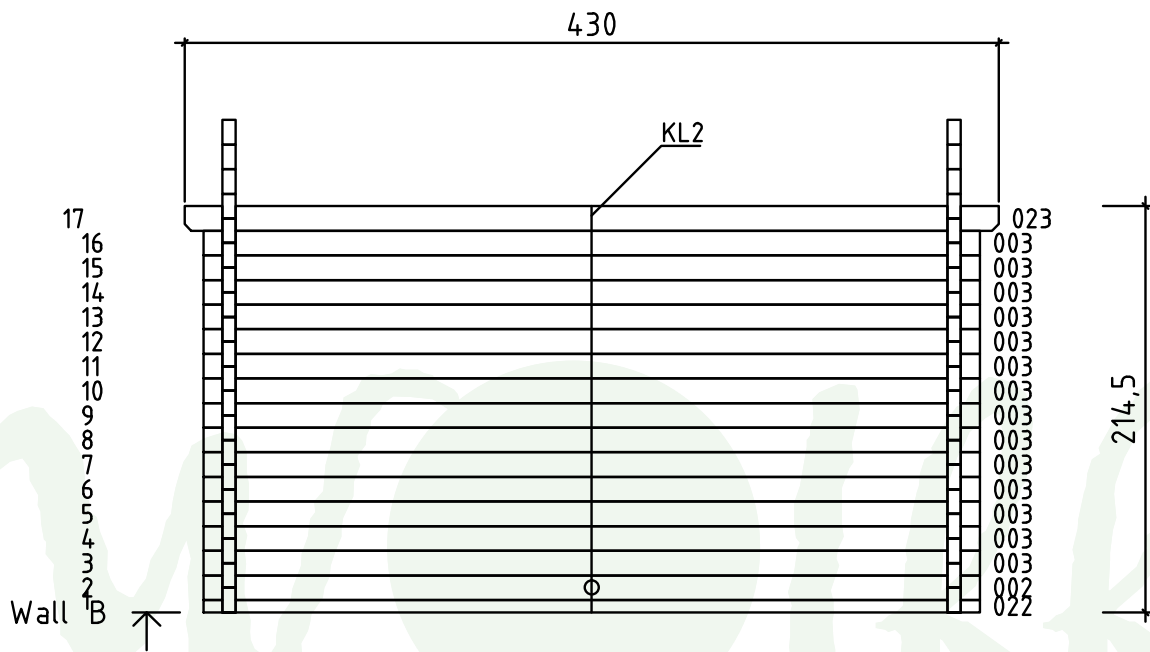
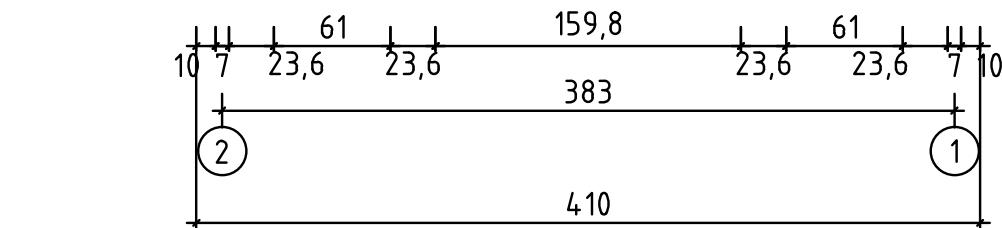
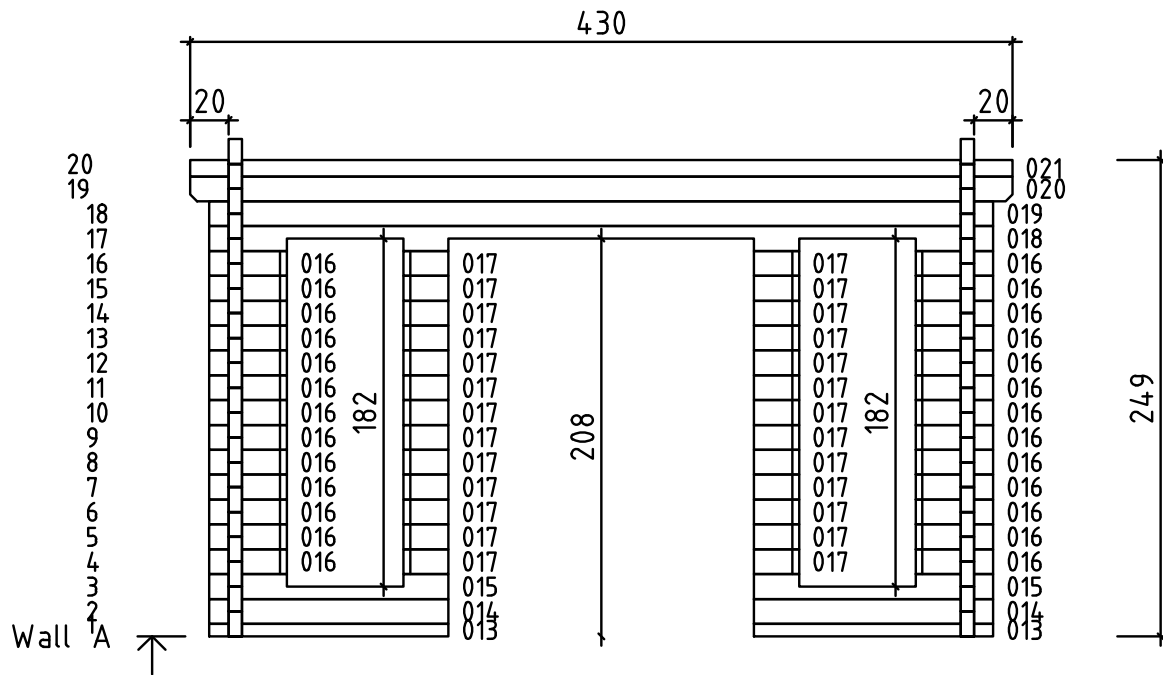

# Wandplan C Trondheim 70-C XL

## Vorgelagerte Vordachbohle vor Wand A

