

# Technische Daten Trondheim 44-C XL

Wandaußenmaß: 390 x 390 cm

Bohlenstärke: 44 mm



Kontrolliert durch:

Achtung: Alle angegebenen Maße sind ca.-Maße!

# 3D-Darstellung und Grundriss Trondheim 44-C XL

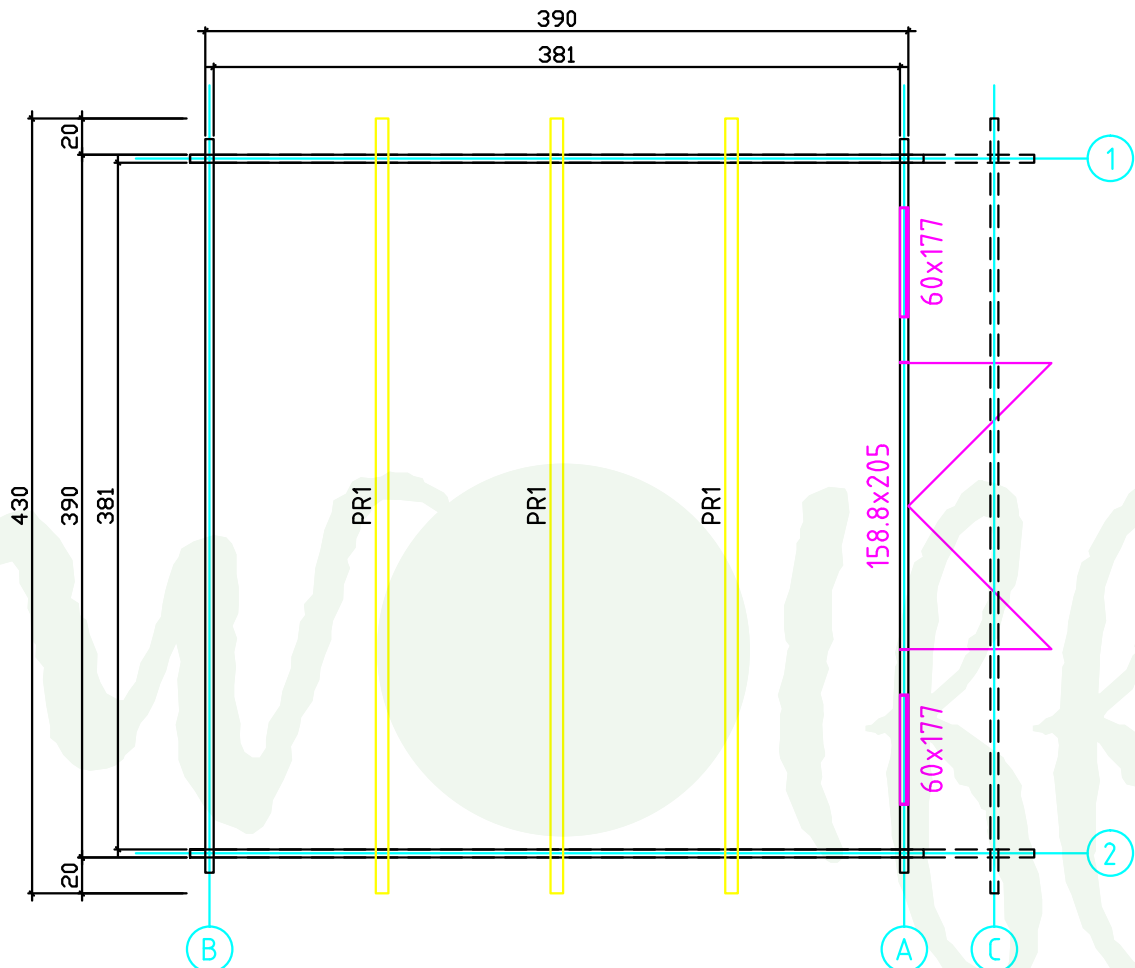
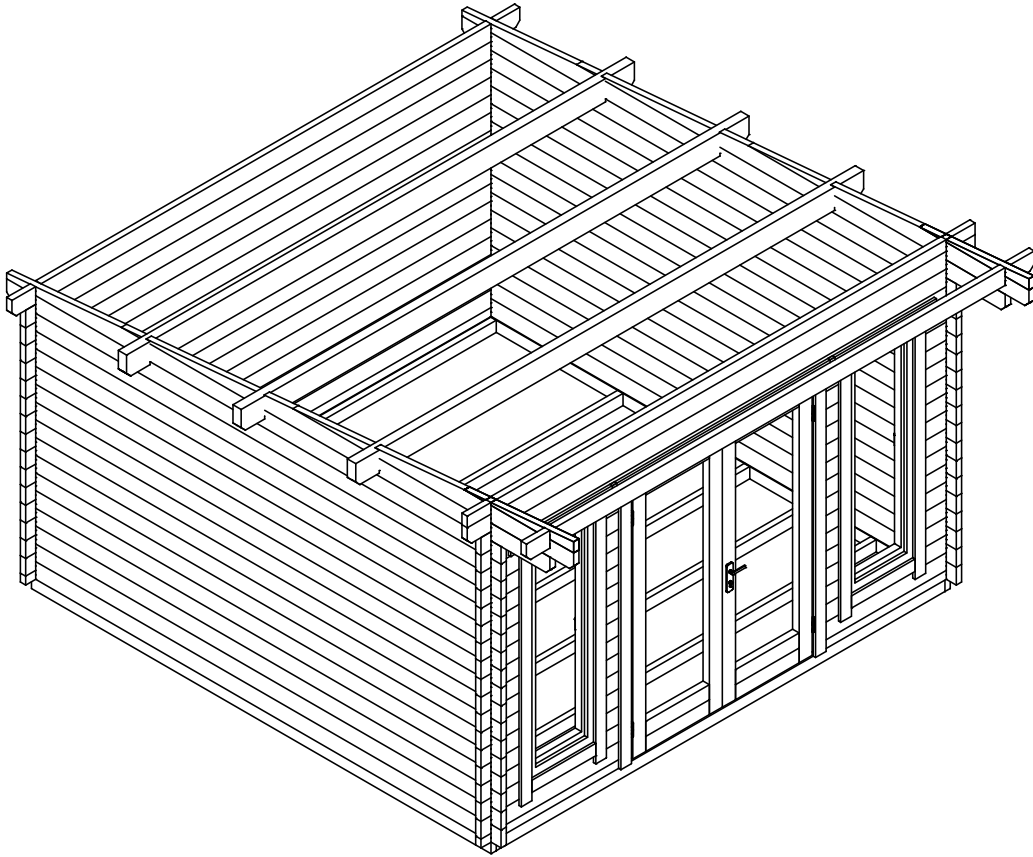





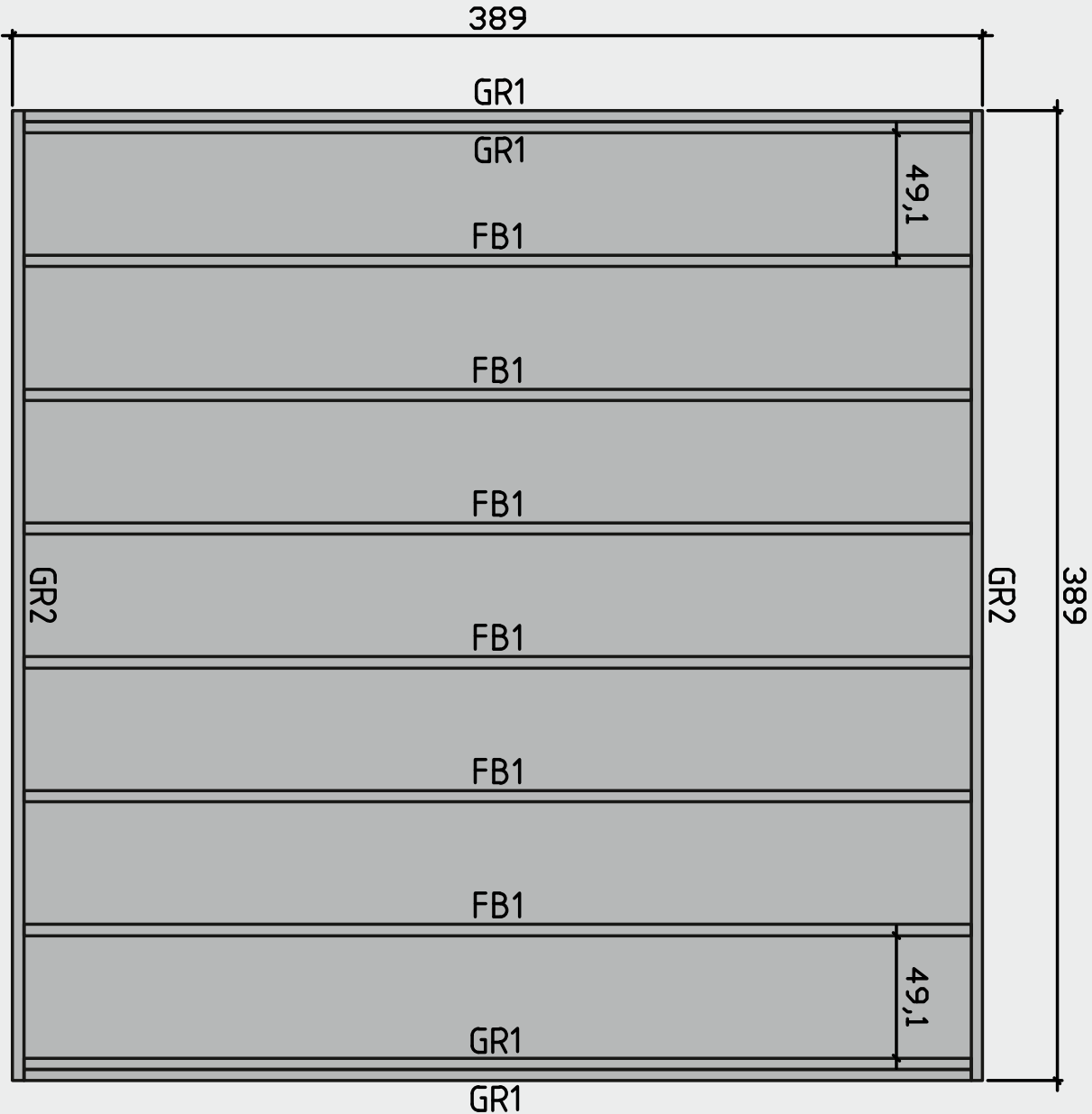





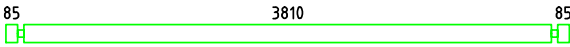
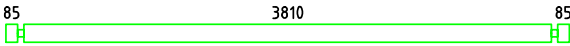
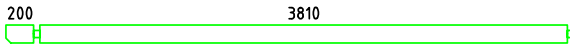
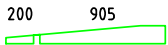
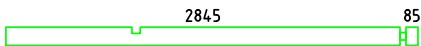

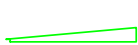
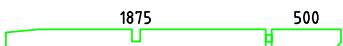
# Lagerholzplan und Fundamentplan Trondheim 44-C XL

Wir empfehlen als Fundament für Ihr Gartenhaus eine vollflächig festgegründete, gepflasterte oder betonierte Fläche.  
Wahlweise ist auch ein Punkt- oder Streifenfundament möglich.

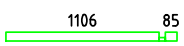
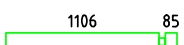
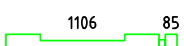

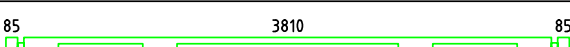

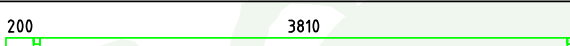
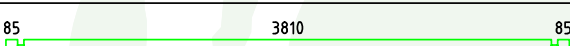
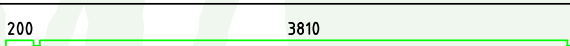
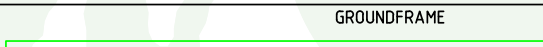

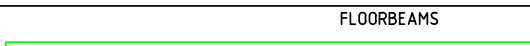
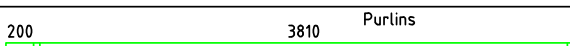



# Teileliste 1

## Trondheim 44-C XL

Pos		Quantity	Profil (mm)	Lenght (mm)
001		2	45x130	4070
002		44	45x130	4070
003		2	45x130	4185
004		2	45x130	1150
005		2	45x130	2975
006		2	45x16	179
007		2	45x103	940
008		2	45x130	2420
009		2	45x60	668
010		2	45x130	1680
011		2	45x83	926
012		2	45x65	1236
013		2	45x130	1236
014		2	45x130	1236
015		26	45x130	378
016		26	45x130	248
017		1	45x130	4070
018		1	45x130	4300
019		1	45x85	4300
020		1	45x65	4070
021		2	45x130	4300
GR2	GROUNDFRAME 	2	45x90	3890
GR1	GROUNDFRAME 	4	45x90	3800
FB1	FLOORBEAMS 	6	45x90	3800
PR1	Purlins 	3	70x170	4300

# Teileliste 2

## Trondheim 44-C XL

Pos		Quantity	Profil (mm)	Lenght (mm)
	WINDOW 600x1770	2		
	DOOR 1588x2050	1		
1	Screws/Schrauben/Vis 5x100 mm- For fixing first row of wall logs /Fixierung des ersten Bohlenkranzes/Pour fixer les lamesde plancher	6		
2	Nails/Nägel/Clous 2.5x50 - For fixing floorboards/ Befestigung Fussbodenbretter/Pour fixer les lames de plancher	350		
3	Nails/Nägel/Clous 2.5x50 - For fixing roofboards/ Befestigung Dachbretter/Pour fixer les voliges	300		
4	Nails/Nägel/Clous 2.5x50 - For fixing floor edge trims/ Befestigung Fussleisten/Pour fixer les plinthes du plancher	30		
5	Nails/Nägel/Clous 2.5x50 - For fixing roofing felt fillet/ Befestigung giebelabschlussbrett/Pour fixer la latte de finition de la couverture	30		
6	Screws/Schrauben/Vis 2,5x50 mm- For fixing roof side boards and roof edge reinforcement Befestigung Traufenbretter und Traufenteisten Pour fixer les planches de rive et le tasseau de refront	150		
7	Screws/Schrauben/Vis 2,5x50 mm- For fixing fascia boards and diamonds/ Befestigung Giebelblende und Raute Pour fixer les planches de rive et le diamant			
8	Screws/Schrauben/Vis 2,5x50 mm- For fixing fwindow and door trims/ Befestigung Fenster und türen/ Pour fixer les croissilons des fenetres et des portes			

# Teileliste 3

## Trondheim 44-C XL

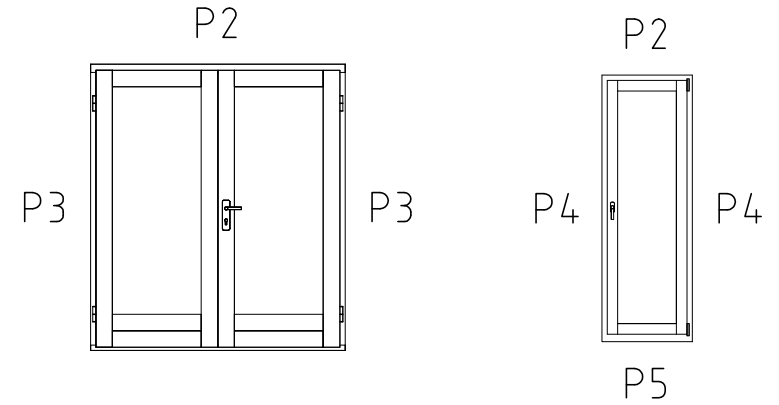
POS	ST.	B	H	L	Teileliste
FB1	Vt. spetsi				FUNDMENTHOLZER
F1	14,5m <sup>2</sup>	28		3805	FUSSBODENBRETTER
PR	3	70	170	4300	DACHBALKEN
RB1	20,7m <sup>2</sup>	20		4819	DACHBRETTER
R1	2	20	140	4340	Traufenbretter
R2	2	45	65	4300	Traufenbretter
R3	2	20	140	5020	Giebelabschlussleiste
R4	2	20	90	5020	Giebelabschlussleiste
DR1 WN1	1 2	1588 600	2050 1770		
P1	17m	20	40		Fußbodenleiste
P2	1+1	20	90	3800	Türleiste DR1, Fensterleiste WN1
P3	2+2	20	90	2030	Türleiste DR1
P4	4+4	20	90	1920	Fensterleiste WN1
P5	2+2	20	90	<del>540</del> 570	Fensterleiste WN1



# Wandplan 1 und 2 Trondheim 44-C XL

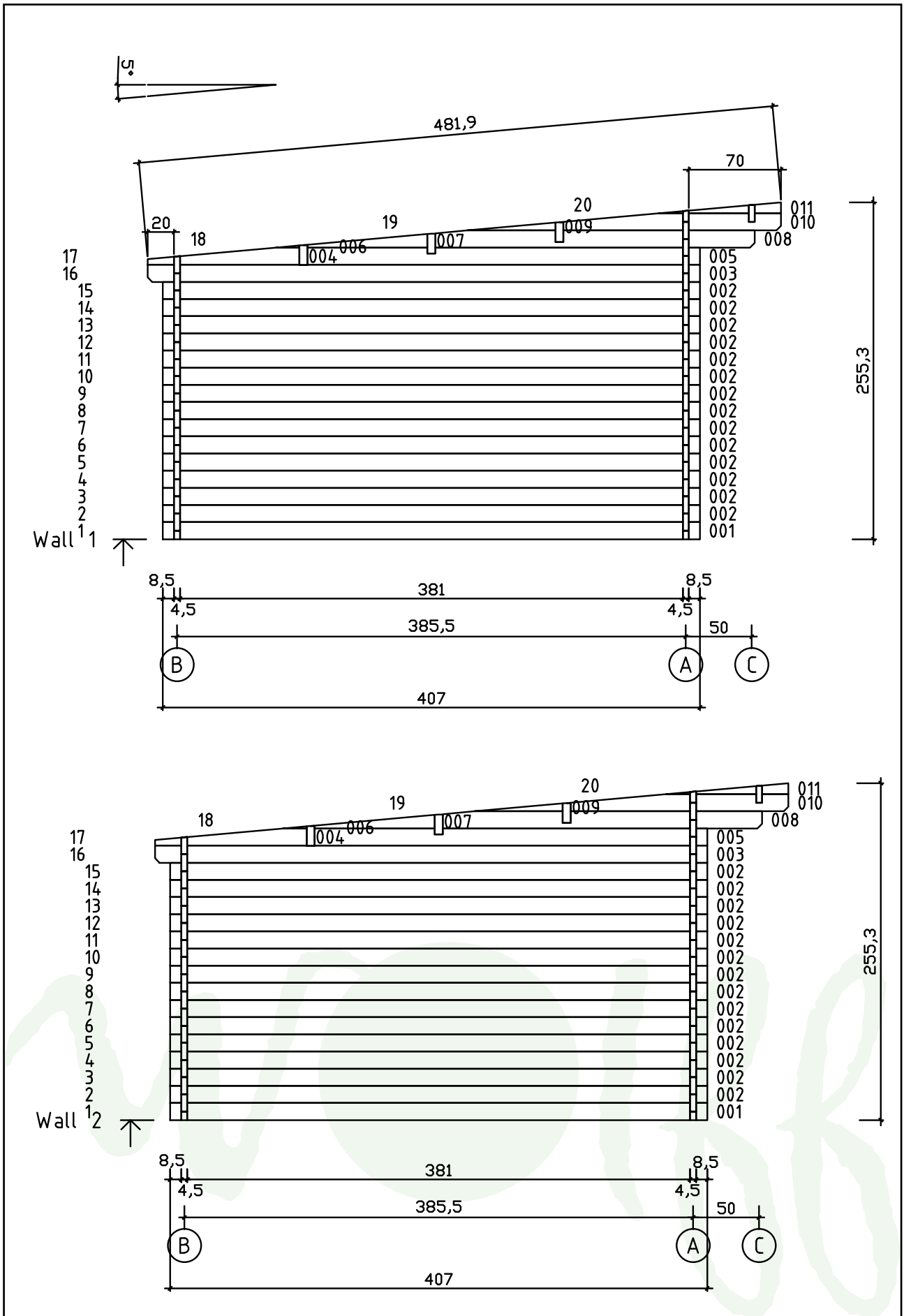

# Wandplan A und B Trondheim 44-C XL

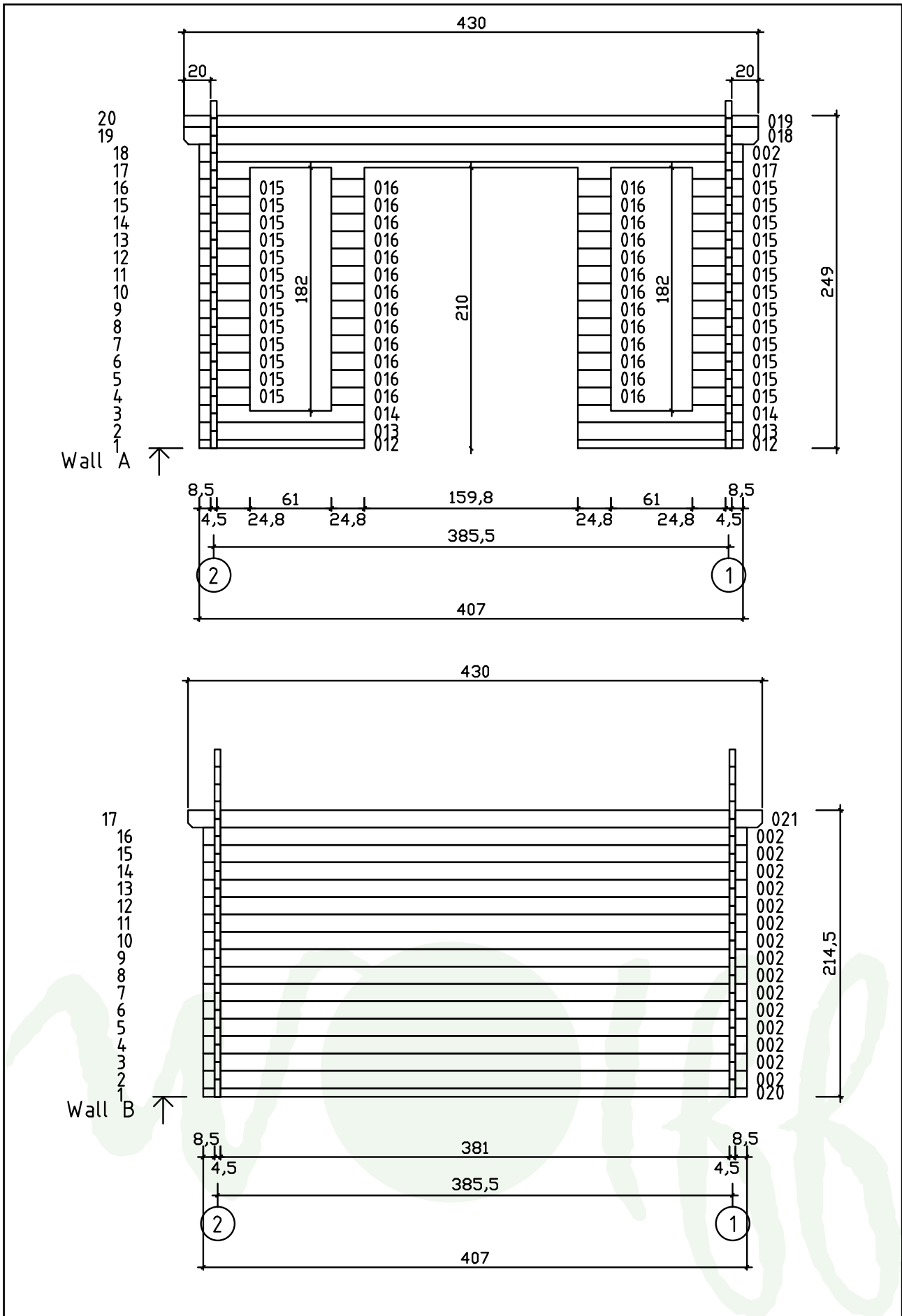



# Wandplan C Trondheim 44-C XL

## Vorgelagerte Vordachbohle vor Wand A

