

Skagen 44-B

Wandaußenmaß: 300 x 300 cm
Bohlenstärke: 44 mm



Kontrolliert durch:

Achtung: Alle angegebenen Maße sind ca.-Maße!

3D-Ansicht Skagen 44-B

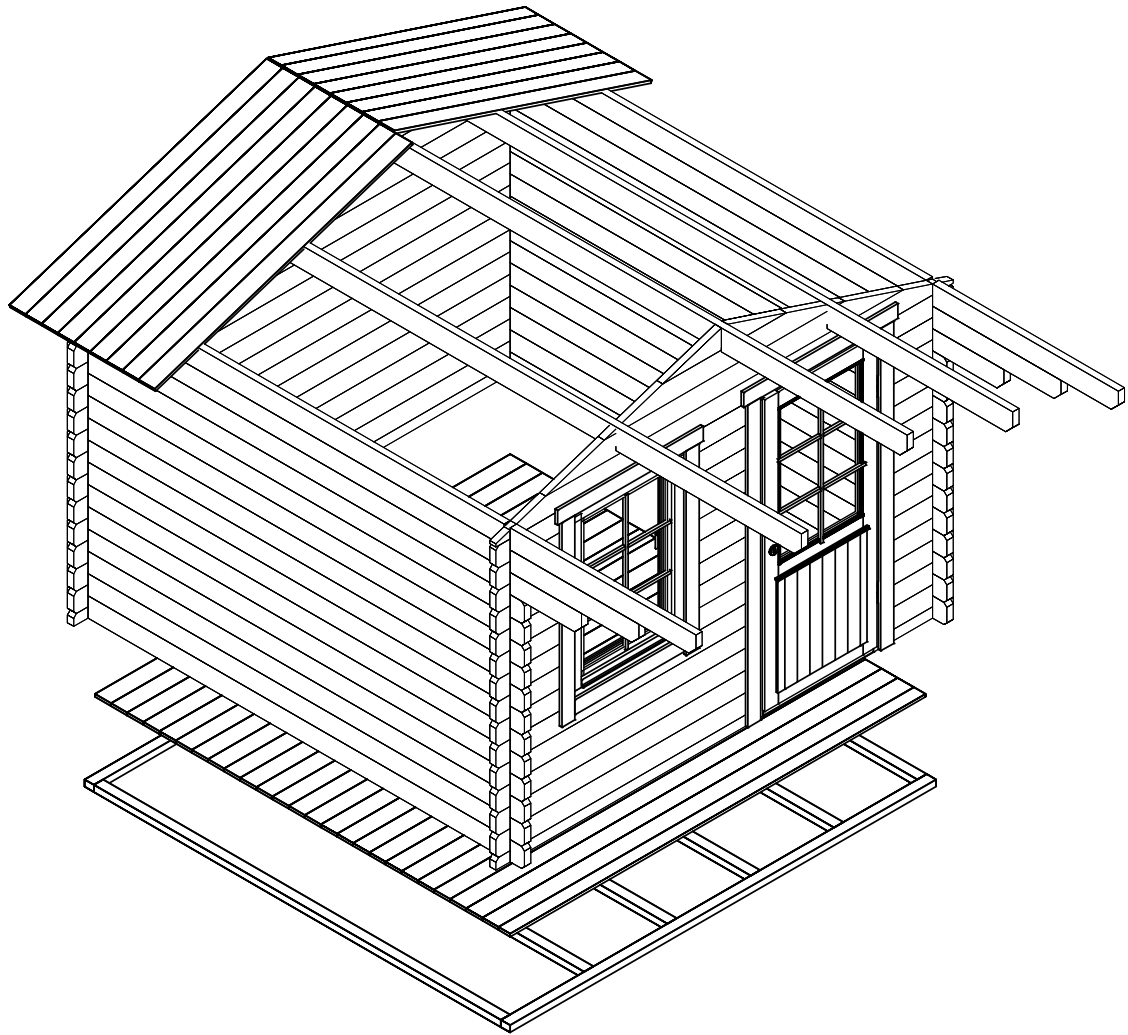

Grundriss Skagen 44-B

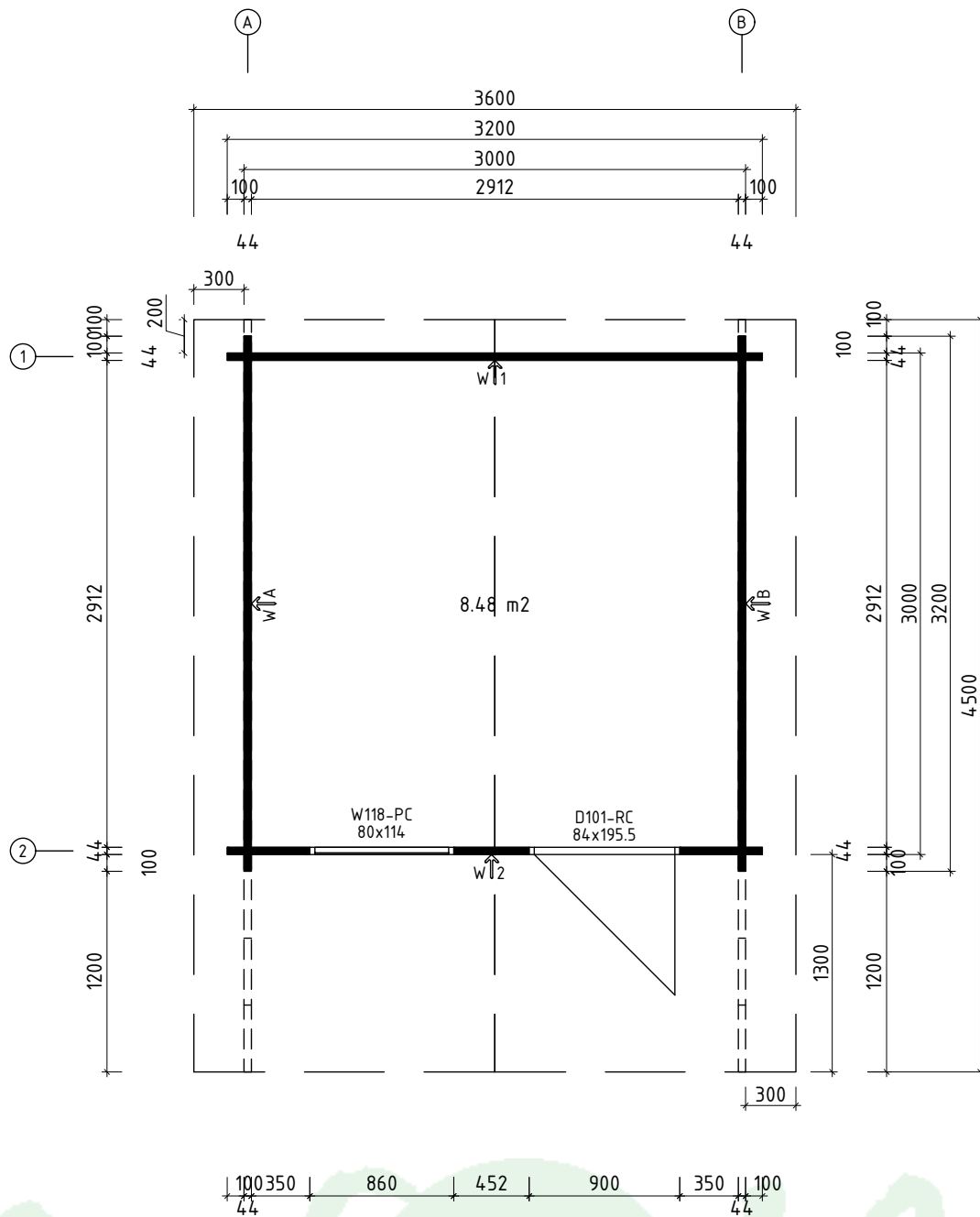

Lagerholzplan und Fundamentplan Skagen 44-B

Wir empfehlen als Fundament für Ihr Gartenhaus eine vollflächig,
festgegründete gepflasterte oder betonierte Fläche.
Wahlweise ist auch ein Punkt- oder Streifenfundament möglich.

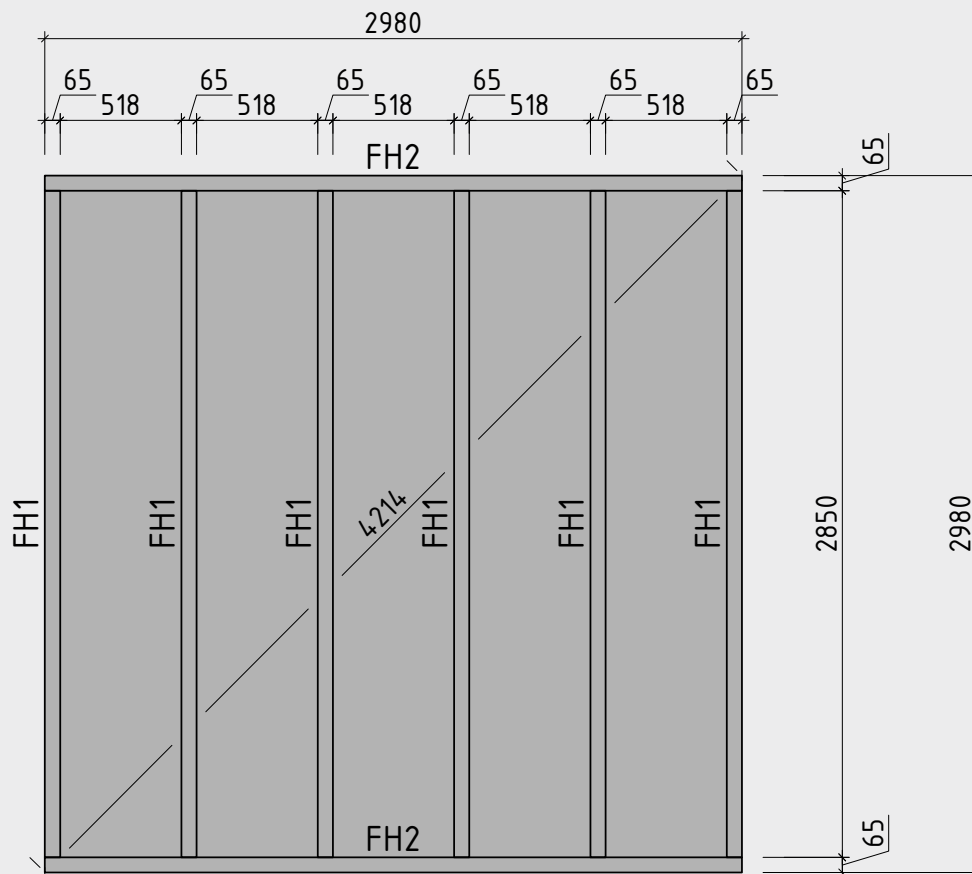











Teilleiste 1

Skagen 44-B

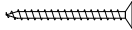
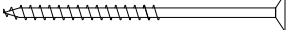
Pos		Stck.	Profil (mm)	Länge (mm)
001		1	44x135	4500
002		1	44x135	4500
003		2	44x135	4000
004		2	44x135	3600
005		1	44x135	3200
006		1	44x68	3200
007		24	44x135	3200
008		14	44x135	3200
009		1	44x135	3200
010		2	44x135	2502
011		5	44x135	1806
012		1	44x68	1806
013		2	44x135	1683
014		23	44x135	494
015		1	44x68	494
016		9	44x135	452
017		4	44x135	410
FH2	FUNDAMENTHÖLZER (imprägniert) 	2	65x44	2980
FH1	FUNDAMENTHÖLZER (imprägniert) 	6	65x44	2850
PF1		3	44x145	4500
	DACHBRETTEN	80+1	113x18	1895
	FUSSBODENBRETTEN	26+1	113x18	2905
	FUSSBODENLEISTE	✓	18x40	12,0 lfdm
G02-1	GIEBELBRETTEN 18x120	✓	18x120	1975
G06-1	GIEBELDECKLEISTEN 18x58	✓	18x58	1975

Teileliste 2

Skagen 44-B

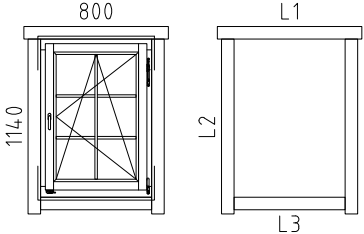
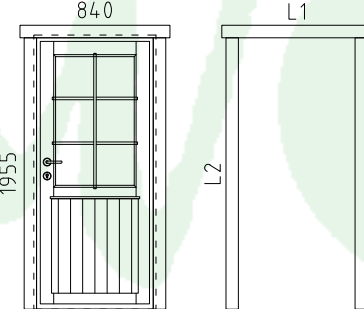
Pos			Stck.	Profil (mm)	Länge (mm)
T01-1	TRAUFENBRETTER 18x90		2	18x90	4500
T06-1	TRAUFENLEISTEN 18x40	 ✓		18x40	9,0 lfdm
GS	Giebelsegment		2		
NG04	NÄGEL 2.5x50	Dachbretter Fussbodenbretter		792	
SR32	SCHRAUBEN 3.0x30	Fussbodenleiste Traufenleiste 18x40		44	
SR37	SCHRAUBEN 3.5x45	Giebelbretter 18x120, Giebeldeckleisten 18x58 Giebelsegment, Traufenbretter 18x90 Tür- und Fensterleisten		102	
SR57	SCHRAUBEN 5.0x100	Fundamenthölzer		32	
SH	Schlaghölzer		3		
KL1	Gewindestange M8		4		2000
KL2	Gewindestange M8		4		55
	Mutter M8 U-Scheibe Ø25		8		
	Befestigungsmutter M8		4		
	FENSTER 800x1140		1		
	 <p style="text-align: right;">W118-PC</p> <p>L1 18x90 L=1040mm 2 Stck. L2 18x90 L=1260mm 4 Stck. L3 18x90 L=800mm 2 Stck. ✓</p>				
	TÜR 840x1955		1		
	 <p style="text-align: right;">D101-RC</p> <p>L1 18x90 L=1080mm 2x L2 18x90 L=1955mm 4x ✓</p> <p style="text-align: right;">DIN rechts</p>				
	✓ - bitte selber anpassen (falls nötig)!				

Wandplan A Skagen 44-B

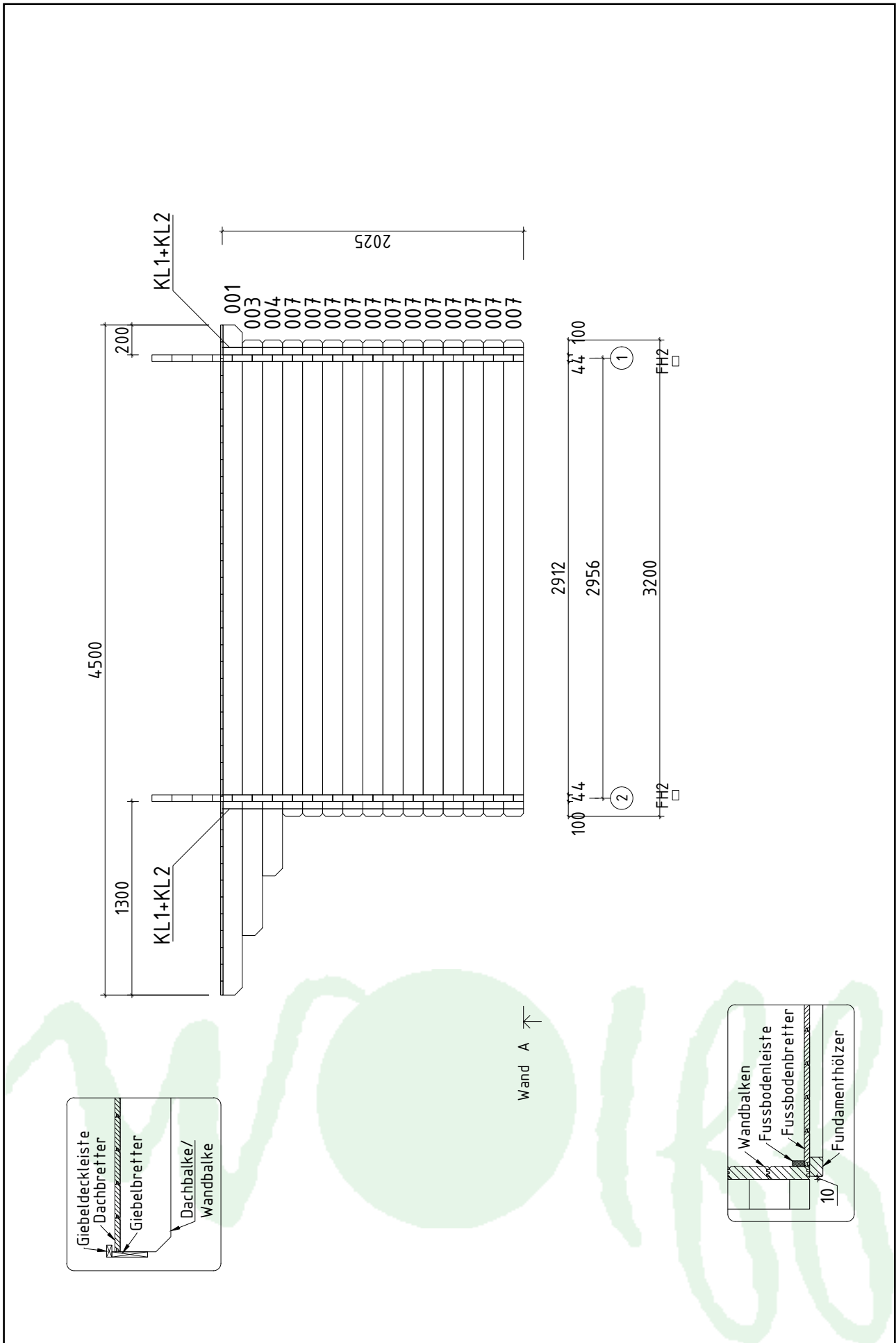

Details

Skagen 44-B

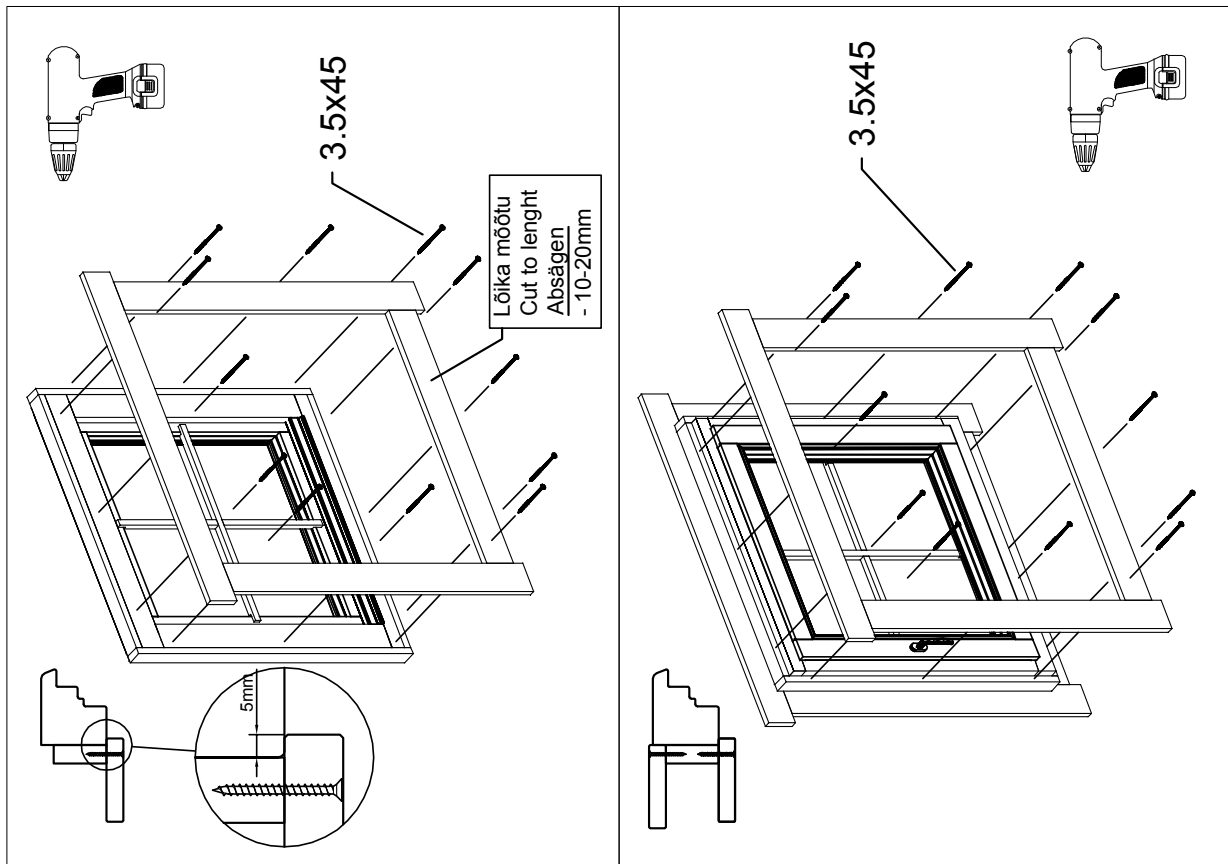

Akna tüüp / Fenster typ / Window type - A68
(GH+ / SH)

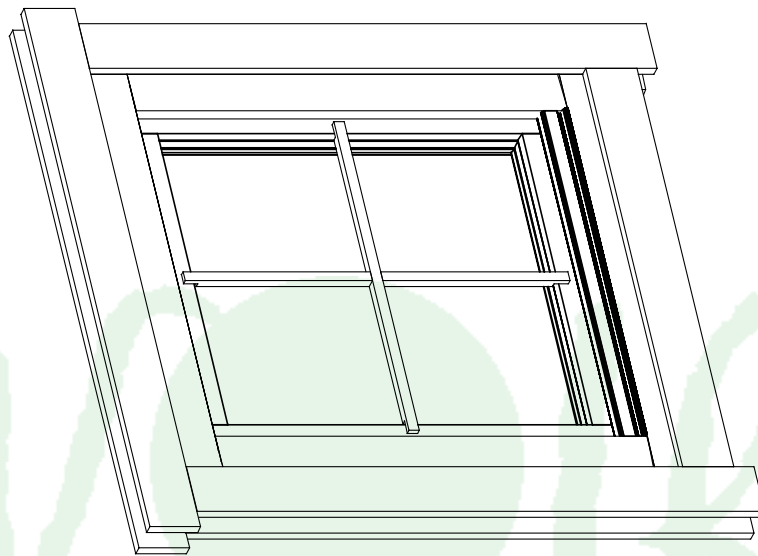

Details Skagen 44-B

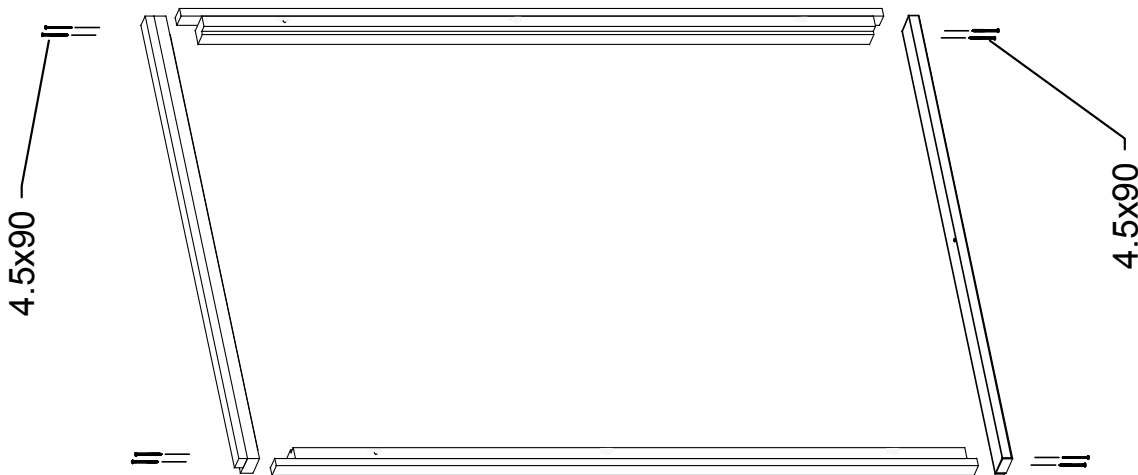

Uksee montaaž / Tür montage / Door assembly
(GH+ / SH)

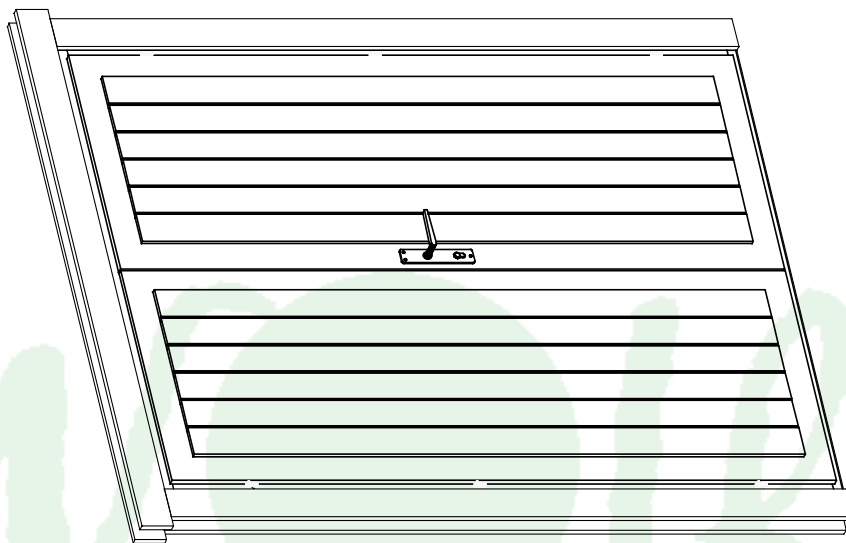

Details Skagen 44-B

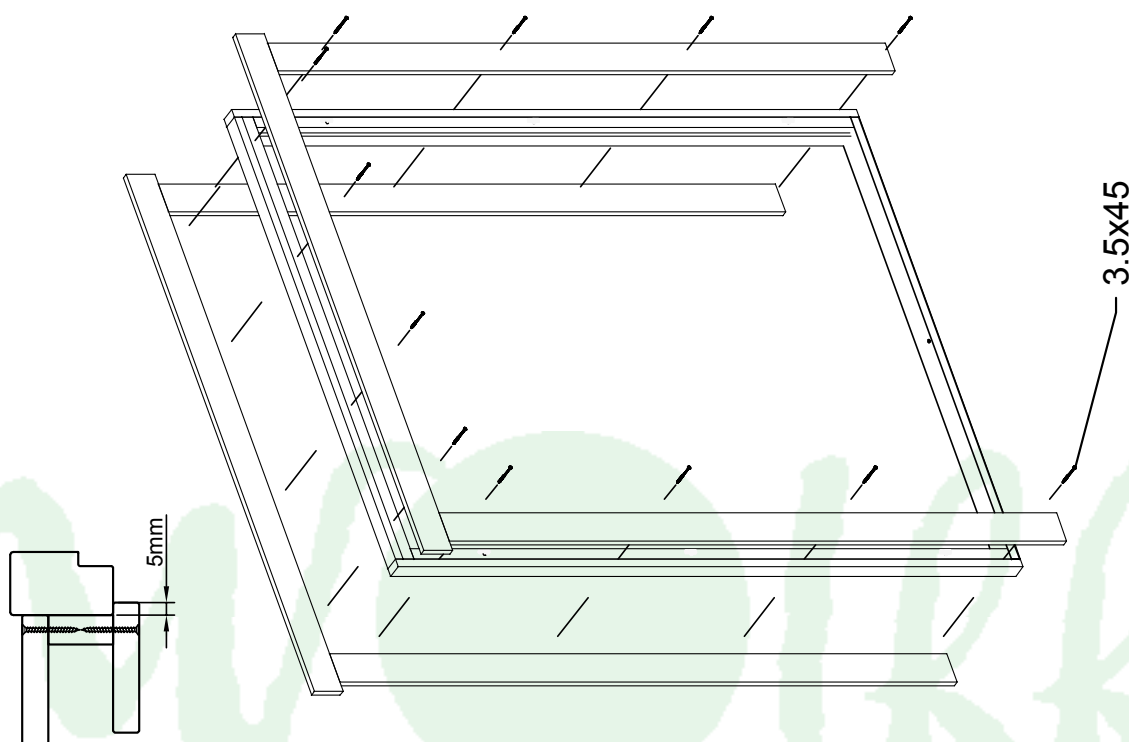
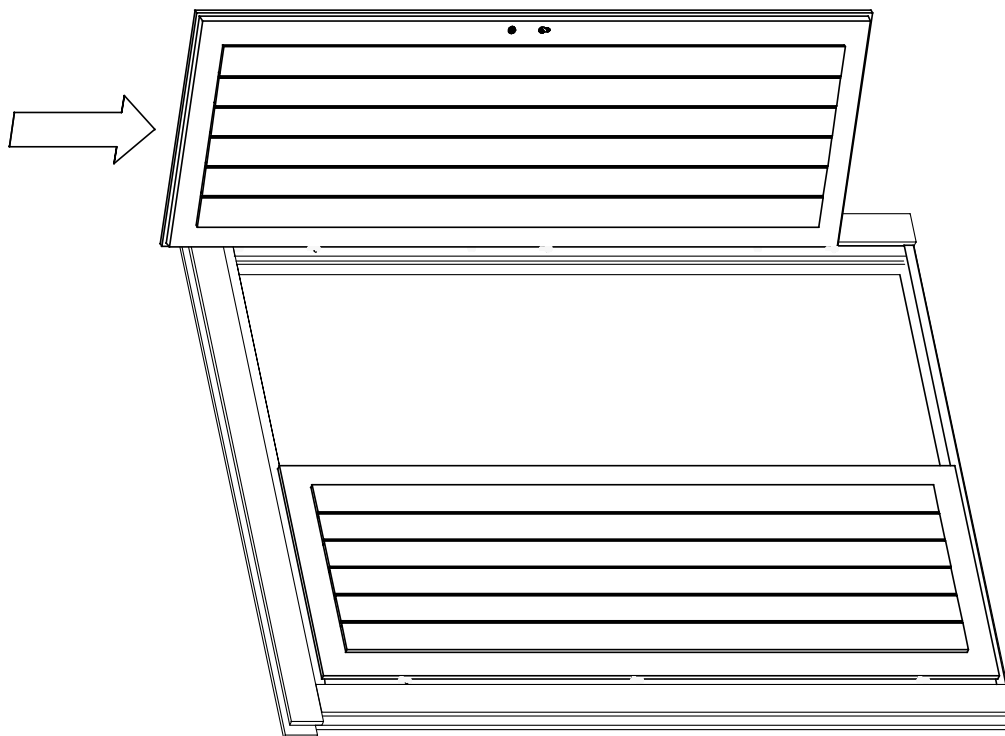

Details Skagen 44-B

