

Lappland 70 A

Wandaußenmaß: 500 x 500 cm

Bohlenstärke: 70 mm



Lappland 70-B, durch Kunden farblich endbehandelt

Kontrolliert durch:

Achtung: Alle angegebenen Maße sind ca.-Maße!

3D-Darstellung und Grundriss Lappland 70 A

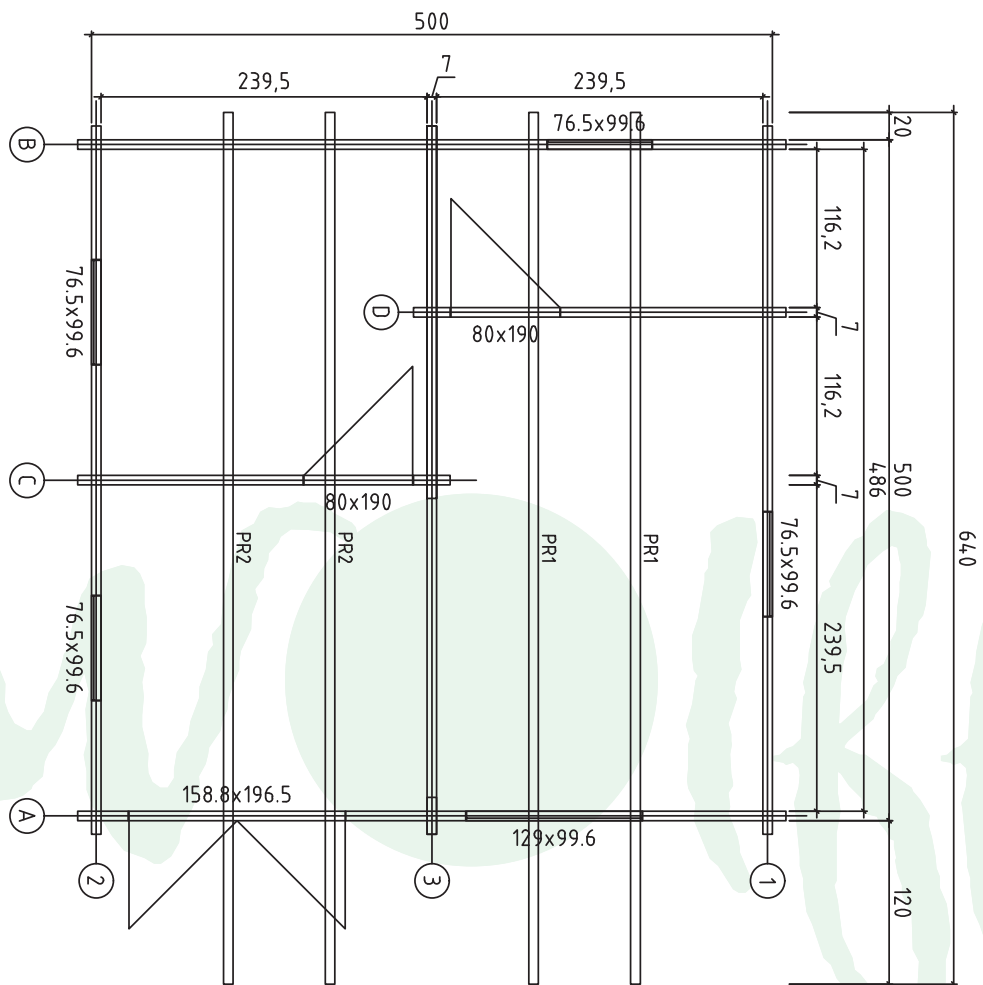
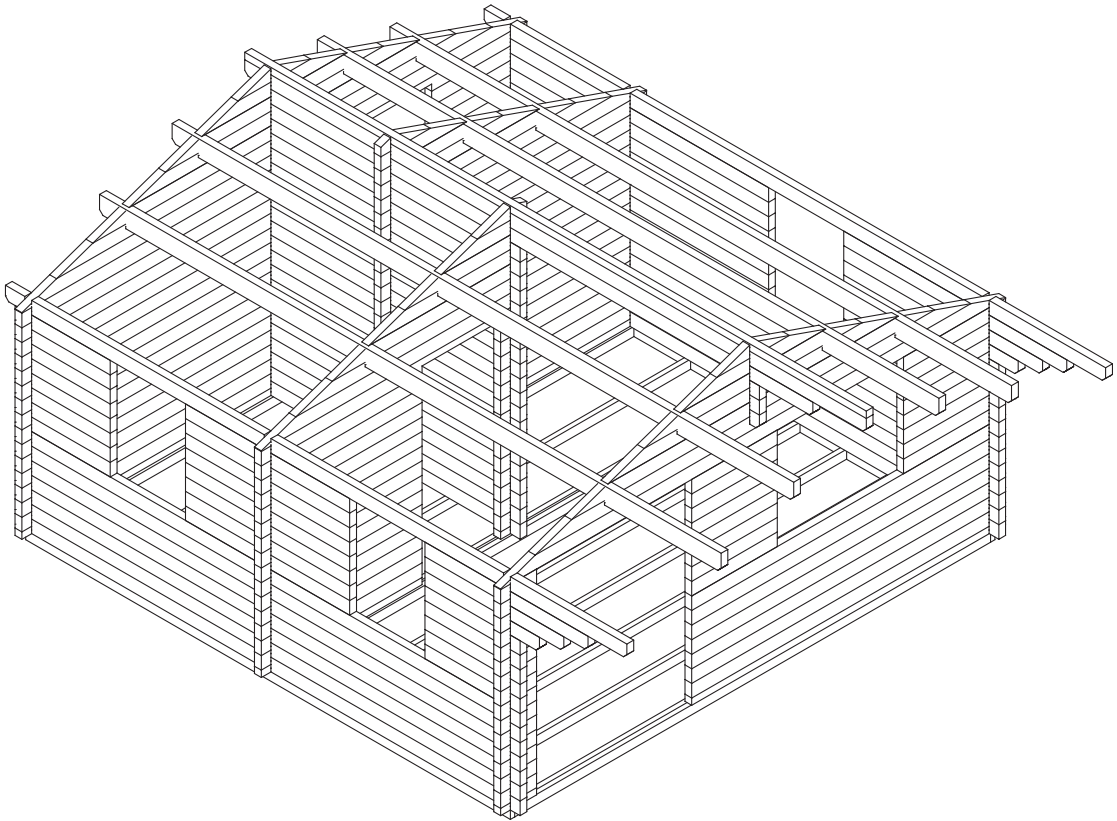

Lagerholzplan und Fundamentplan Lapland 70 A

Wir empfehlen als Fundament für Ihr Gartenhaus eine vollflächig,
festgegründete gepflasterte oder betonierte Fläche.
Wahlweise ist auch ein Punkt- oder Streifenfundament möglich.

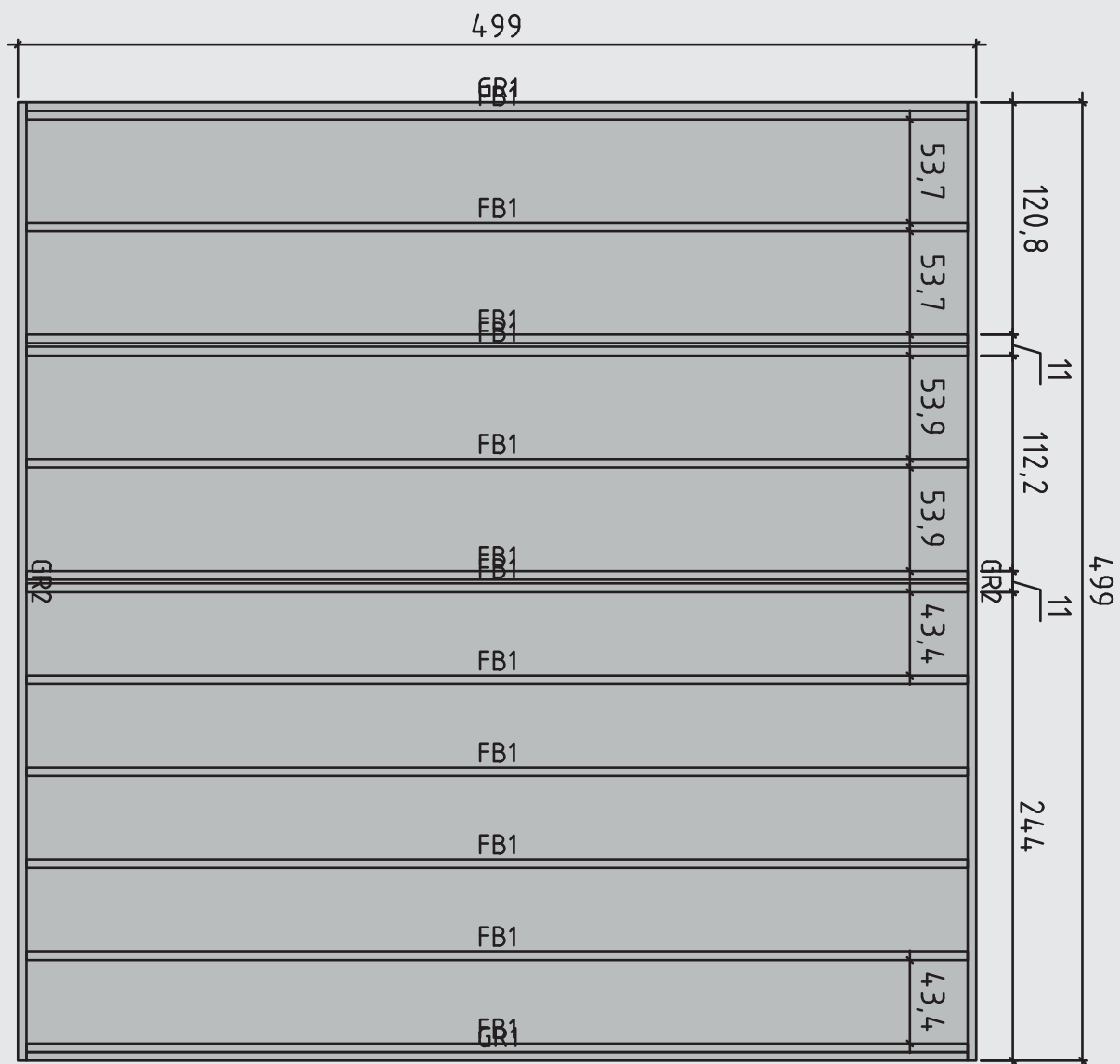

Teileliste 1







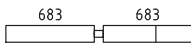
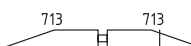
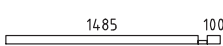

Lappland 70 A

Pos			Profil (mm)	Lenght (mm)
001		1	70x130	5200
002		1	70x130	5200
003		5	70x130	5200
004		8	70x130	2829
005		5	70x130	1596
006		1	70x130	1796
007		1	70x130	2046
008		1	70x130	2296
009		1	70x130	6400
010		1	70x130	5200
011		1	70x130	5200
012		5	70x130	5200
013		13	70x130	980
014		8	70x130	1690
015		1	70x130	1180
016		1	70x130	1430
017		1	70x130	1680
018		1	70x130	6400
019		1	70x130	2735
020		19	70x130	2735
021		1	70x130	270
022		30	70x130	270
023		1	70x130	5750
024		1	70x130	6400
025		1	70x65	6400

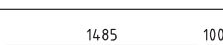

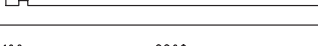
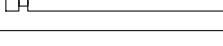
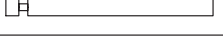
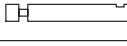
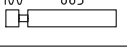



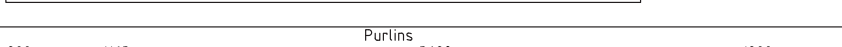
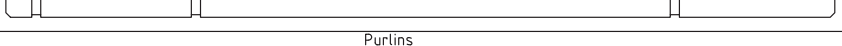



Teileliste 2 Lapland 70 A

Pos			Profil (mm)	Lenght (mm)
026		1	70x65	370
027		1	70x65	3232
028		15	70x130	370
029		7	70x130	3232
030		8	70x130	881
031		8	70x130	1051
032		1	70x130	5200
033		1	70x130	4486
034		12	70x120	344
035		1	70x130	2931
036		1	70x130	2991
037		1	70x130	1435
038		1	70x130	1495
039		2	70x118	748
040		1	70x65	5200
041		1	70x130	5200
042		5	70x130	5200
043		1	70x130	5200
044		7	70x130	3445
045		7	70x130	980
046		1	70x130	5200
047		1	70x130	5200
048		1	70x130	4486
049		1	70x130	2931
050		1	70x130	2991











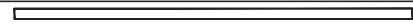



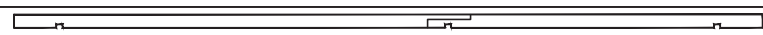



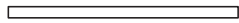

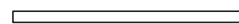

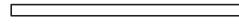
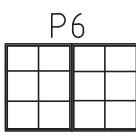
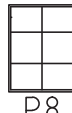
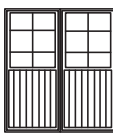
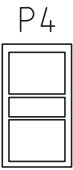

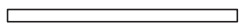

Teileliste 3 Lapland 70 A

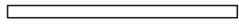
Pos			Profil (mm)	Lenght (mm)
051		1	70x130	1435
052		1	70x130	1495
053		2	70x65	1655
054		2	70x65	270
055		28	70x130	1655
056		2	70x130	2735
057		2	70x130	2735
058		2	70x130	2378
059		2	70x130	1600
060		2	70x130	1630
061		2	70x130	853
062		2	70x130	883
063		2	70x118	509
GR2	GROUNDFRAME 	2	45x90	4990
GR1	GROUNDFRAME 	2	45x90	4900
FB1	FLOORBEAMS 	12	45x90	4900
PR1	Purlins 	2	70x170	6400
PR2	Purlins 	2	70x170	6400
	WINDOW 1290x996	1		
	WINDOW 765x996	4		
	DOOR 1588x1965	1		
	DOOR 800x1900	2		

Teileliste 4 Lappland 70 A

Pos			Profil (mm)	Lenght (mm)
1	Screws/Schrauben/Vis 5x100 mm- For fixing first row of wall logs /Fixierung des ersten Bohlenkranzes/Pour fixer les lames de plancher		6	
2	Nails/Nägel/Clous 2.1x50 - For fixing floorboards/ Befestigung Fussbodenbretter/Pour fixer les lames de plancher		495	
3	Nails/Nägel/Clous 2.1x50 - For fixing roofboards/ Befestigung Dachbretter/Pour fixer les voliges		550	
4	Nails/Nägel/Clous 2.1x50 - For fixing floor edge trims/ Befestigung Fussleisten/Pour fixer les plinthes du plancher		30	
5	Nails/Nägel/Clous 2.1x50 - For fixing roofing felt fillet/ Befestigung giebelabschlussbrett/Pour fixer la latte de finition de la couverture		20	
6	Screws/Schrauben/Vis 3,5x50 mm- For fixing roof side boards and roof edge reinforcement Befestigung Traufenbretter und Traufenleisten Pour fixer les planches de rive et le tasseau de refrent		44	
7	Screws/Schrauben/Vis 3,5x50 mm- For fixing fascia boards and diamonds/ Befestigung Giebelblende und Raute Pour fixer les planches de rive et le diamant		28	
8	Screws/Schrauben/Vis 3,5x50 mm- For fixing fwindow and door trims/ Befestigung Fenster und türen/ Pour fixer les croisillons des fenetres et des portes		68	
9	Metal storm Brace/Gewindestange/Tige filetee 10 mm		5	
10	Shim,Nuts/Mutter ,U-Scheibe/Ecrou,Rondelle 10 mm For fixing storm braces/ Pour fixer les anti tempete/ Für Sturmleisten Pour fixer les croisillons des fenetres et des portes Metal storm Brace/Gewindestange/Tige filetee 10 mm KL1 M10 2,18 m 4 Screws 180 10 pcs. KL2 M10 2,89m 1 Plastic caps 5 pcs.		5/5	

Teileliste 5 Lapland 70 A

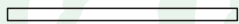
POS	ST.	B	H	L	ERKLÄRUNG		
FB1	Vt. spetsi					FLOORBEAMS	
F1	11,5m ²	28		2390		FUSSBODENBRETTER 56/43/35	
F2	8,68m ²	28		3623		FUSSBODENBRETTER 28/21/18	
F3	2,78m ²	28		1157		FUSSBODENBRETTER 28/21/18	
PR	4	70	170	6400		ROOFBEAMS	
RB1	37,3m ²	20		2912		Dachbretter 148/113/93	
R1	4	20	120	3200	<i>Vaata katuse kaldenurka</i> 	Frontboard	
R2	4	45	65	3200	<i>Vaata katuse kaldenurka</i> 	Frontboard fixing board	
R3	4	20	120	3150	<i>Vaata katuse kaldenurka</i> 	Girders facade	
R4	4	20	90	3150		Topboard	
WN29 WN07	1 4	1290 765	996 996		 P6 P4  P4 P7	Sliding slats 30x30x1900 mm - 2 pcs. 30x30x900 mm - 2 pcs.	
DR15 DR08	1 2	1588 800	1965 1900		 P2 P3 P2	External door	 P5 P4 P5
P1	35m	20	40			Floor edge trim	
P2	2+2	20	90	1945		Fixing boards for DR15	
P3	1+1	20	90	1890		Fixing boards for DR15	
P4	32	20	90	1100		Fixing boards for DR08, WN29, WN07	
P5	4+4	20	90	1880		Fixing boards for DR08	
P6	1+1	20	90	1590		Fixing boards for WN29	
P7	1+1	20	90	1250		Fixing boards for WN29	
P8	4+4	20	90	725		Fixing boards for WN07	

Detailzeichnungen Lappland 70 A

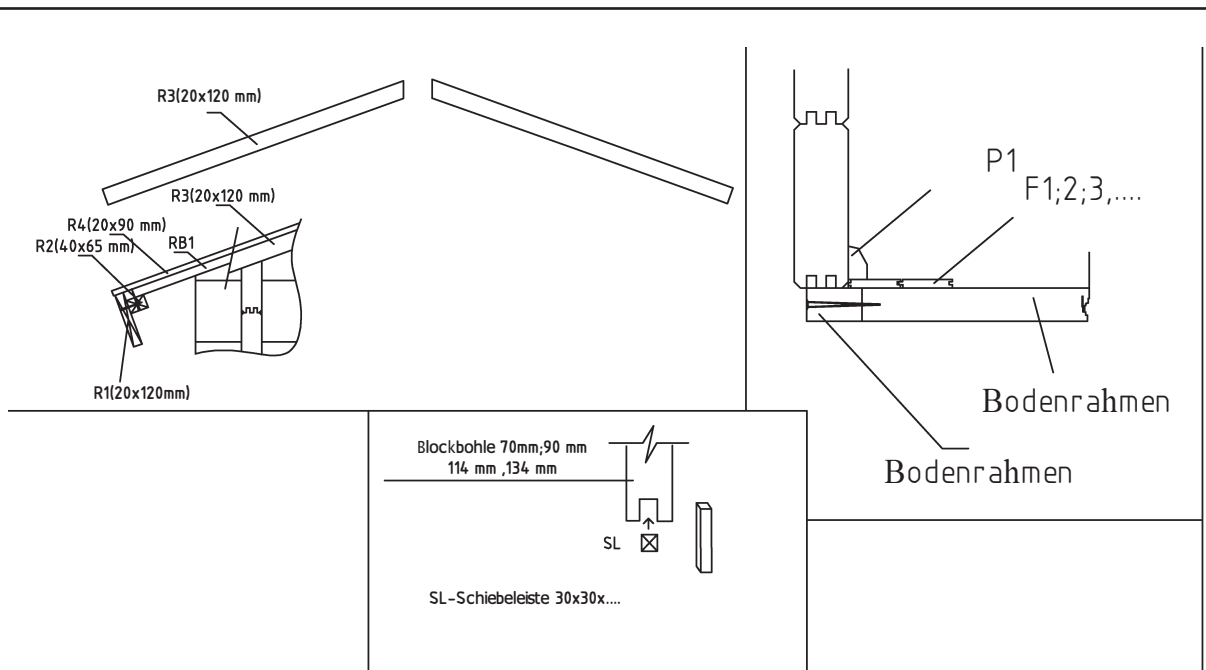

Dichtungssystem der Blockbohlen

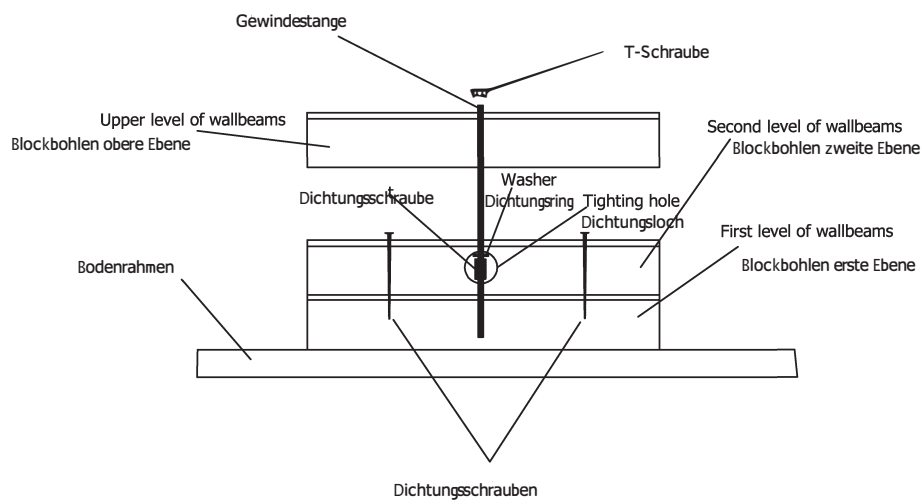

Wandplan 1 und 2 Lappland 70 A

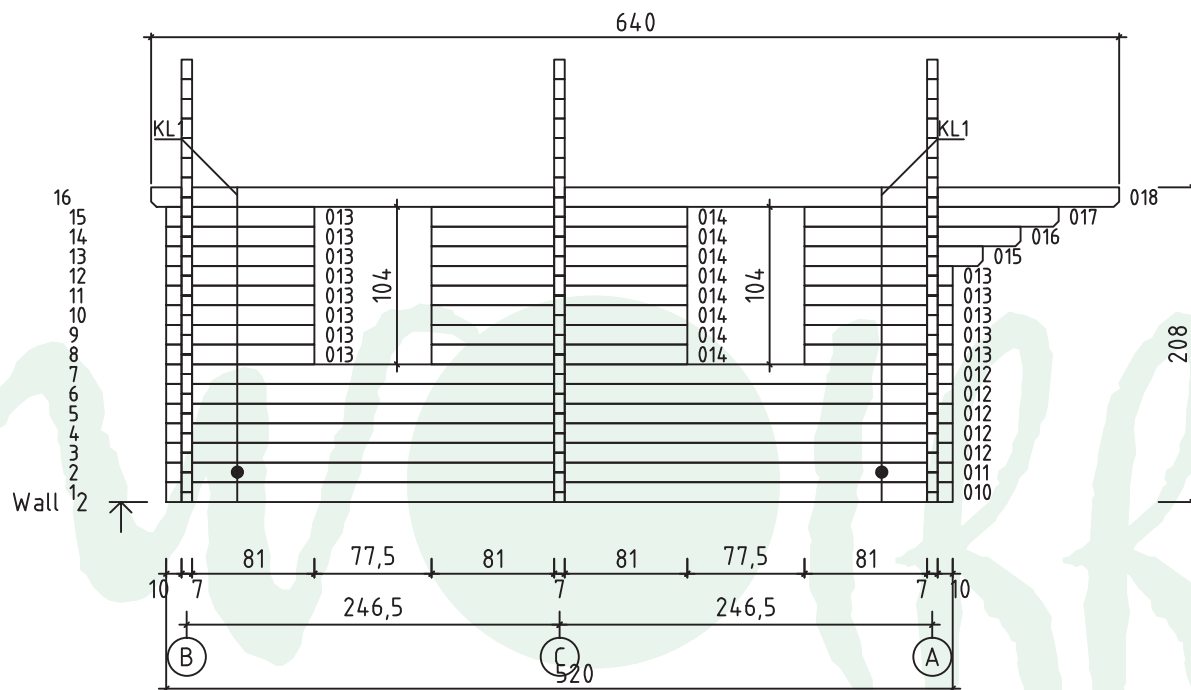
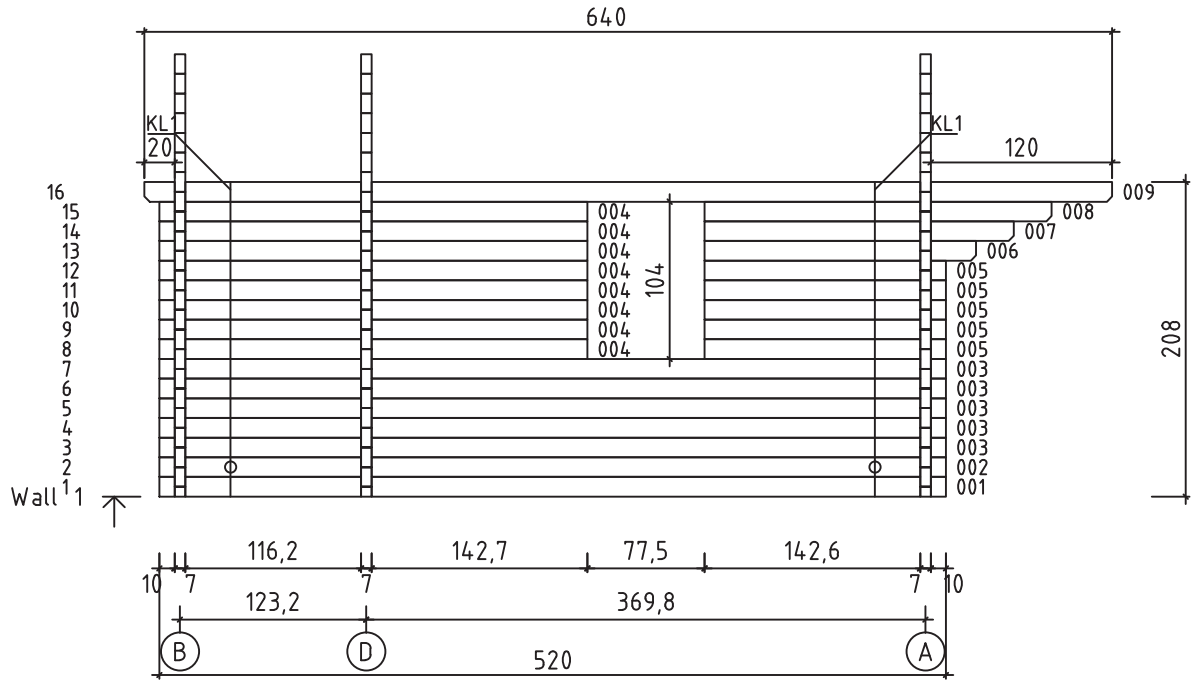

Wandplan 3 Lappland 70 A

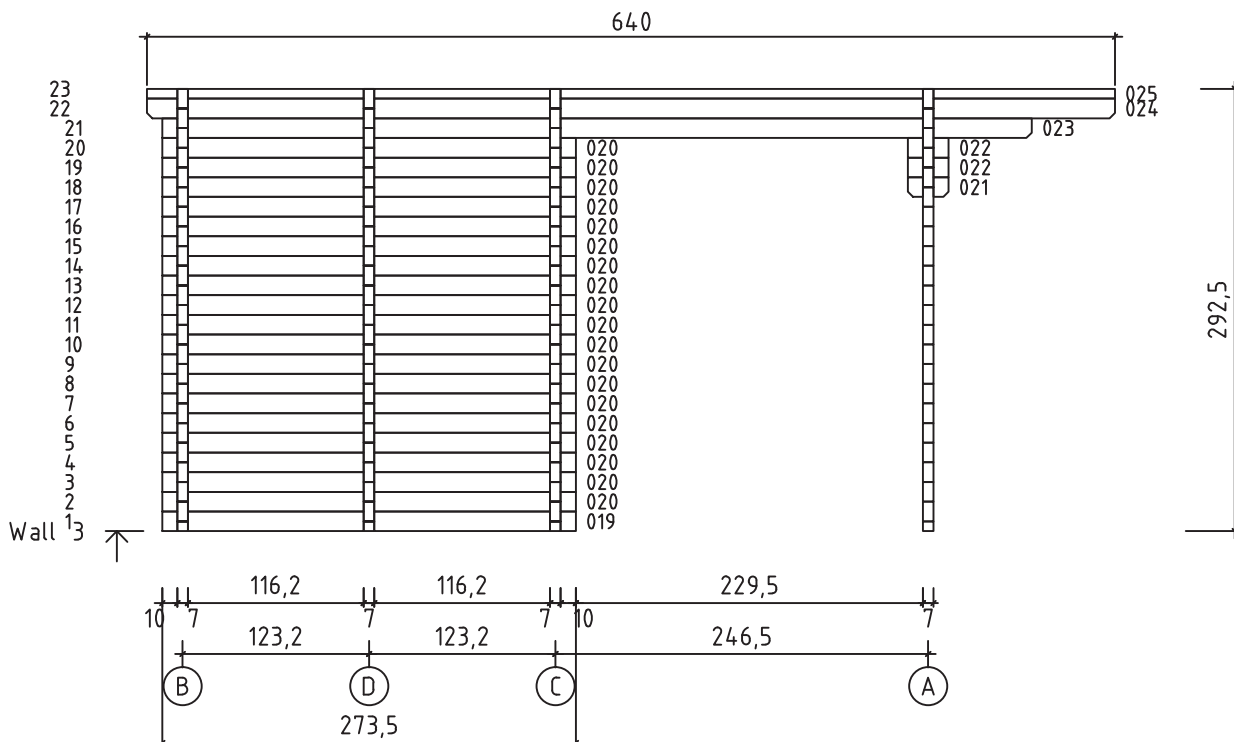

Wandplan A und B Lappland 70 A

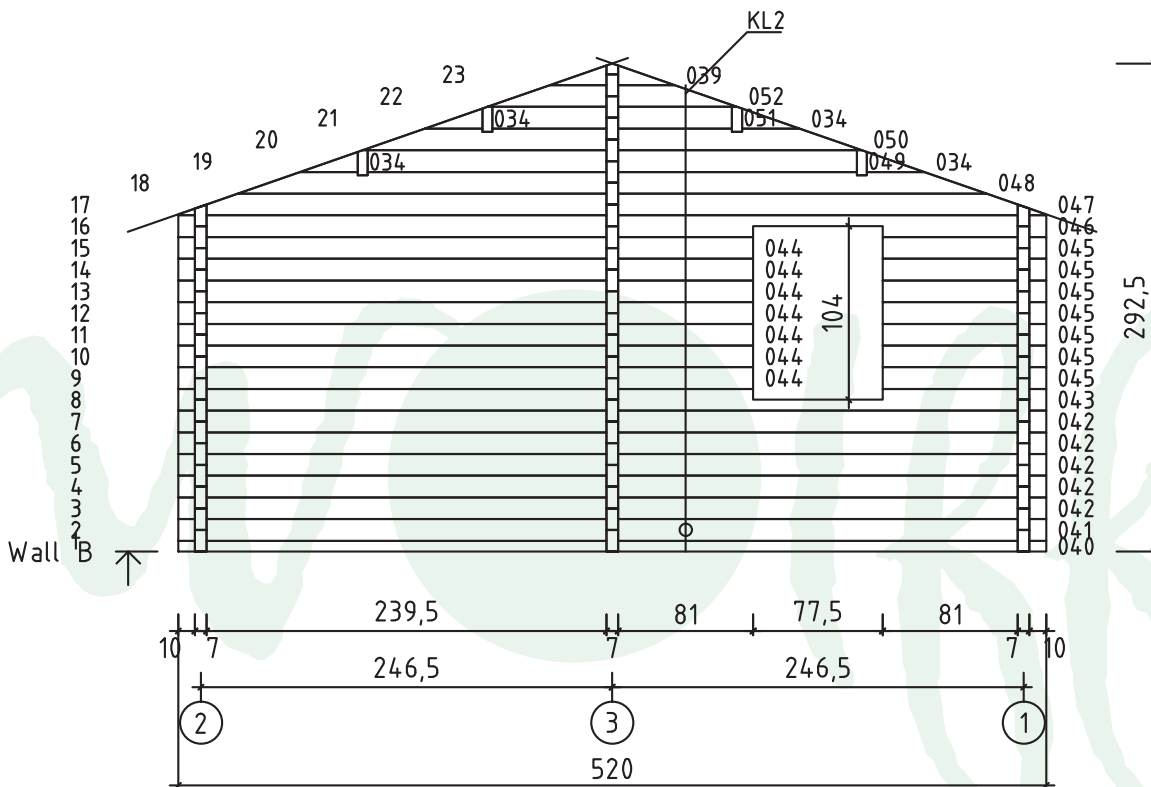
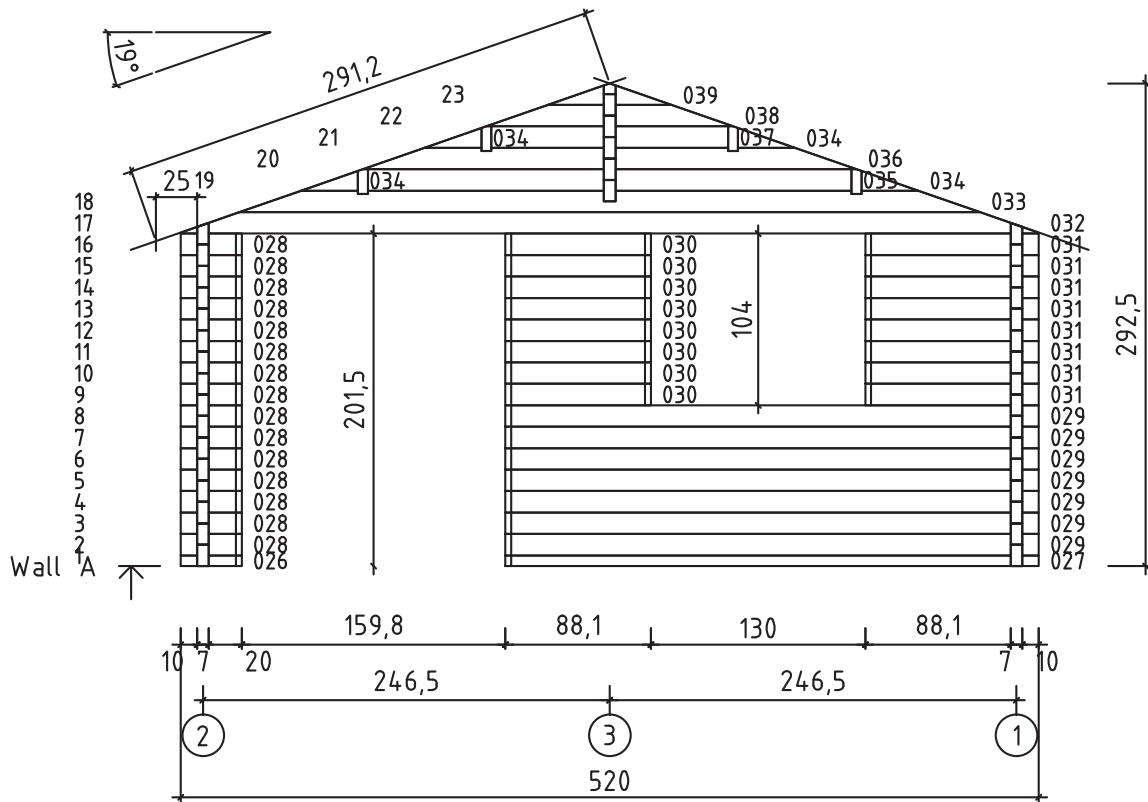

Wandplan C und D Lappland 70 A

