

Rosenbögen Spaliere Czardas System



Montageanleitung

Vielen Dank, dass Sie sich für einen Rosenbogen oder ein Spalier aus unserem Czardas System entschieden haben.

Alle Rankelemente sind aus **pflegeleichtem** und **wetterfesten Kunststoff** hergestellt. Nachfolgend finden Sie die Montagehinweise für jedes Modell.

Die **Montage** der einzelnen Teile erfolgt ohne Werkzeug **im Stecksystem**. **Optional** benötigen Sie einen **6-10mm Bohrer**.

Bei **Rückfragen** stehen wir Ihnen gerne zur Verfügung:
service@khw-geschwenda.de

**Montageanleitung Rosenbogen
ab Seite 3**

**Montageanleitung Spalier
ab Seite 9**

Rosenbogen **Übersicht der Varianten**



Rosenbogen mit Pflanzkästen



Rosenbogen

Inhalt

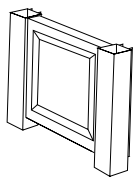

4 x Seitenteil
mit Pfosten

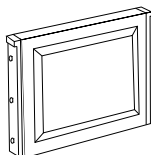

4 x Seitenteil

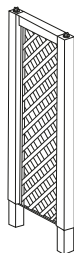

2 x Spalier



4 x Kappe

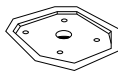

2 x Bodenplatte



4 x Seitenteil
Rosenbogen

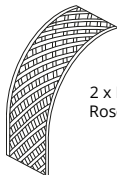

2 x Mittelteil
Rosenbogen

Aufbau

1

2 x

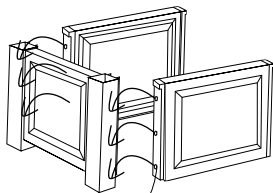

1.  
2. 
3.  

1. runde Laschen in Durchbrüche stecken

2. Bauteil herunterdrücken

3. hörbar einrasten lassen

**Achtung! Bei zu großer
Krafteinwirkung besteht
Bruchgefahr!**

2

2 x

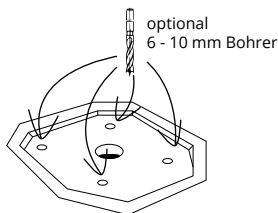

3

2 x

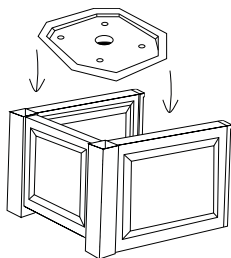

4

2 x

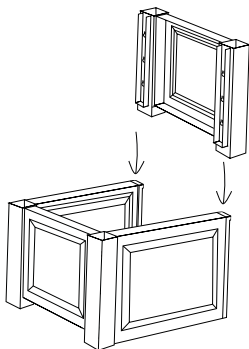

5

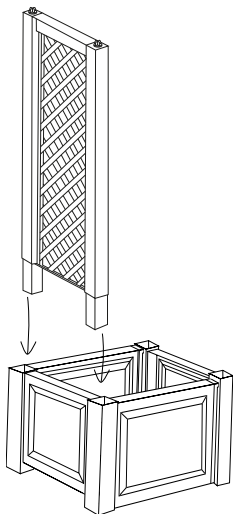
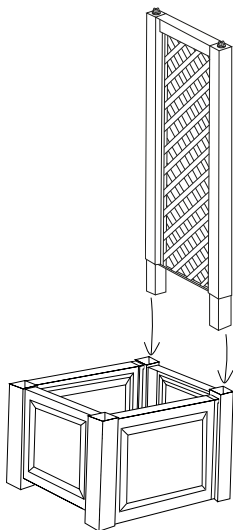

6

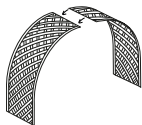

7

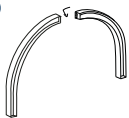

2 x

1. aneinander halten
2. zusammen stecken

8

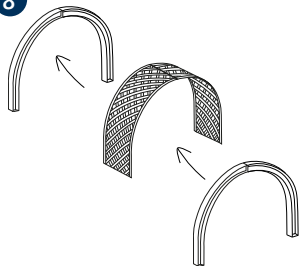

9

1. aneinander halten
2. versetzt und von hinten auf die Kreuzdome schieben

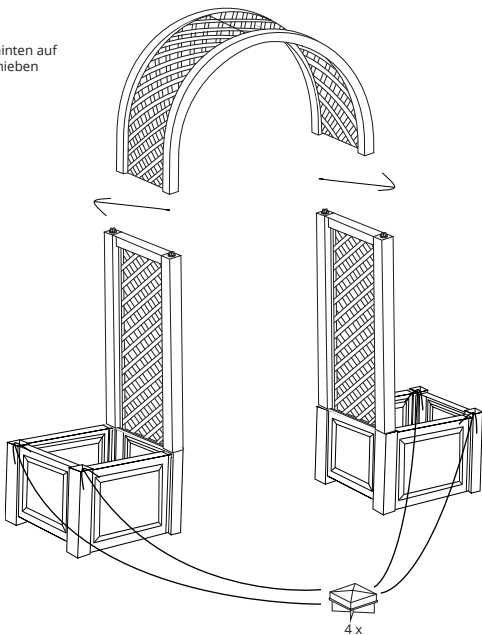

Rosenbogen

Inhalt

Art. 3790...

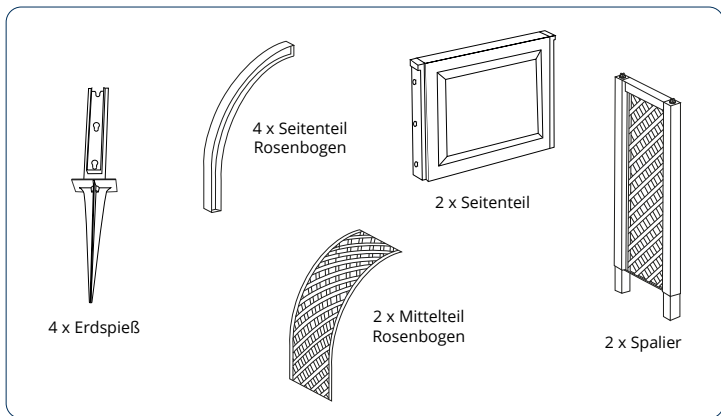

Aufbau

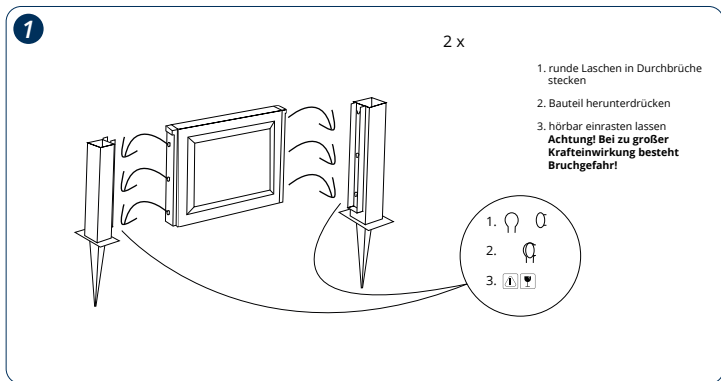

2

2 x

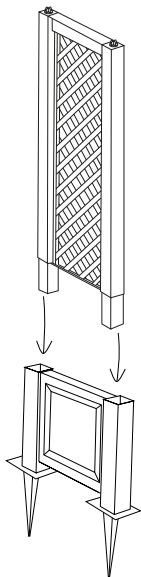

3

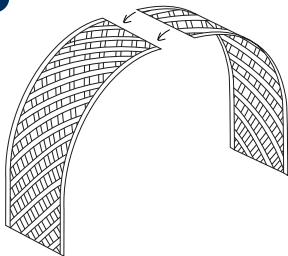

4

2 x

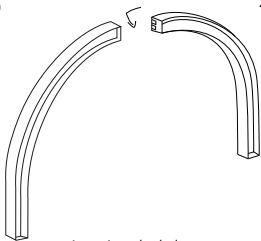

1. aneinander halten
2. zusammen stecken

5

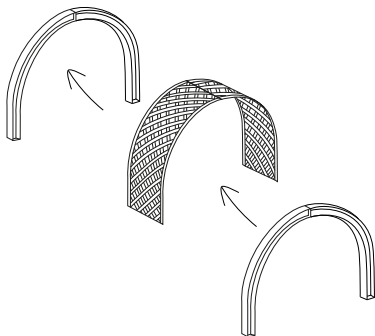

6

1. aneinander halten
2. versetzt und von hinten auf die Kreuzdome schieben

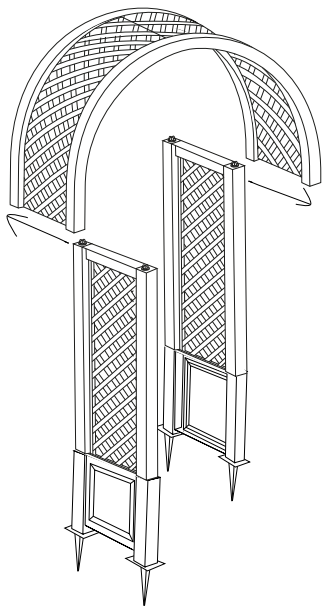

Spalier

Übersicht der Varianten



Spalier 43 cm



Spalier 100 cm

Inhalt

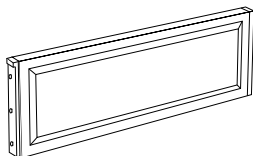

1 x Seitenteil
100 cm Art. 4770.



2 x Kappe
100 cm Art. 4770.



2 x Kappe
43 cm Art. 3780.



Verbinder
100 cm Art. 4770.

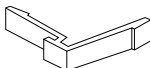

Eck-Verbinder



2 x Erdspieß

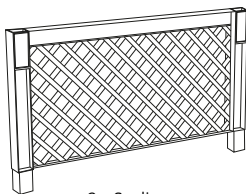

2 x Spalier
100 cm Art. 4770.

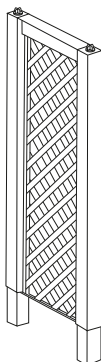

1 x Spalier
43 cm Art. 3780.

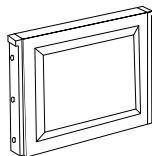

1 x Seitenteil
43 cm Art. 3780.

Aufbau

1

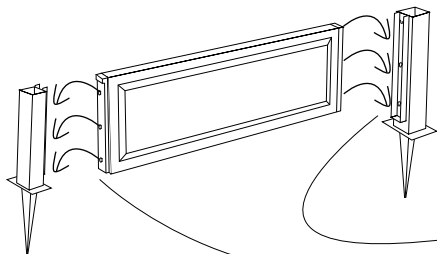

1. runde Laschen in Durchbrüche stecken
2. Bauteil herunterdrücken
3. hörbar einrasten lassen
**Achtung! Bei zu großer
Krafteinwirkung besteht
Bruchgefahr!**



2

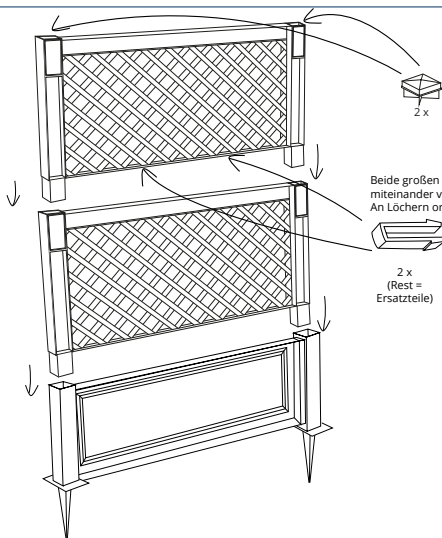

Beide großen Spaliere
miteinander verbinden.
An Löchern orientieren!

2 x
(Rest =
Ersatzteile)

Spaliere

Verbindungsmöglichkeiten



2 x

Seiten der Spaliere miteinander verbinden - an Löchern orientieren!



2 x

Seiten der Spaliere miteinander verbinden - an Löchern orientieren!

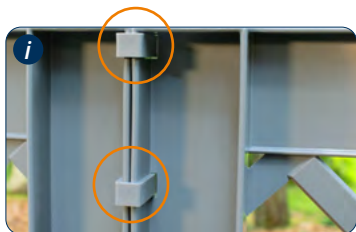

2 x 

Seiten der Spaliere miteinander verbinden - an Löchern orientieren!

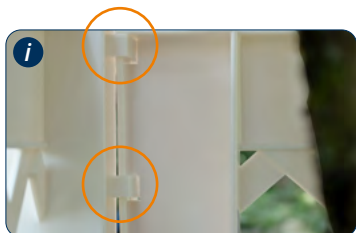

2 x 

Seiten der Spaliere miteinander verbinden - an Löchern orientieren!