

92992

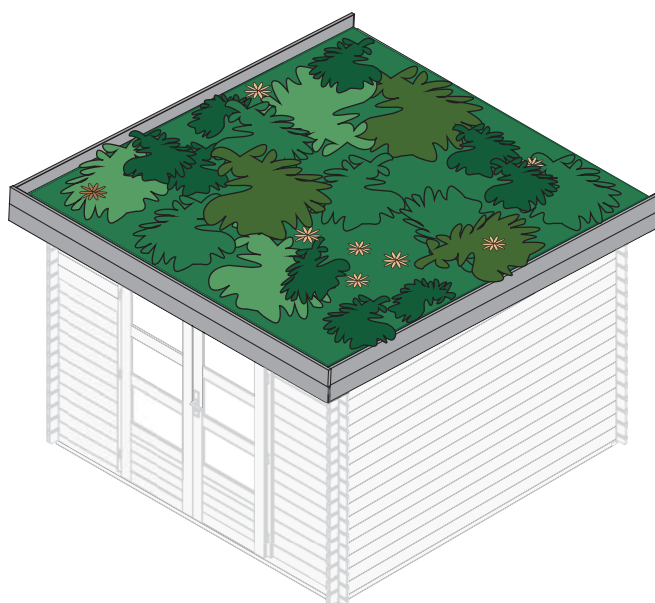

-  **Aufbauanleitung**
-  **Building Instructions**
-  **notice de montage**
-  **montagehandleiding**
-  **Montagevejledning**
-  **Instrucciones de construcción**
-  **Istruzioni per il montaggio**
-  **Montážní návod**
-  **Navodila za sestavljanje**

Bitte bewahren Sie die Anleitung und den Garantieschein zur Seriennummer auf.

Vernichten Sie diese erst nach Ablauf der Garantiezeit.

Eventuelle Beanstandungen können mithilfe der Stückliste einfacher zugeordnet werden.

#### Beigelegte Dokumente

- Informationsheft
- Garantieschein zur Seriennummer
- Typenschild inkl. Warnhinweise (Sauna)
- ggf. Zubehör-Anleitungen in externen Paketen

- \*  Nicht im Lieferumfang enthalten  
 Not included  
 Non comprises dans la livraison  
 Niet bijgeleverd

-  No forman parte del suministro  
 Non incluso  
 V ceně není zahrnuto  
 Ikke inkluderet  
 Ni včlučeno v obseg dobave

- 1  Länge muss ermittelt und zugesägt werden  
 Length must be determined and sawn  
 La longueur doit être déterminée et sciée  
 De lengte moet worden bepaald en worden gezaagd

-  La longitud debe ser determinada y aserrada  
 La lunghezza deve essere determinata e segata  
 Délka musí být určena a rozřezána  
 Længden skal bestemmes og saves  
 Določiti je treba dolžino in jo odrezati po velikosti.

- 2  Nicht gebraucht  
 Not needed  
 Pas nécessaire  
 Niet nodig

-  No es necesario  
 Non necessario  
 Není nutná  
 Ikke nødvendigt  
 Ne uporabljaja se

- 3  Mit Zubehör  
 With accessories  
 Avec accessoires  
 Met toebehoren

-  Con accesorios  
 Con accessori  
 S příslušenstvím  
 Med tilbehør  
 Z dodatki

- 4  Fixiert vorübergehend  
 Fixed temporarily  
 Temporairement fixe  
 Tijdelijk vast

-  Temporalmente fijo  
 Temporaneamente fisso  
 Dočasně pevný  
 Midlertidigt rettet  
 Začasno popravi

- 5  Bestand vom Haus  
 Inventory of the house  
 Inventaire de la maison  
 Inventaris von het huis

-  Inventario de la casa  
 Inventario della casa  
 Inventář domu  
 Inventar af huset  
 Inventarizacija hiše

 Vergleichen Sie zuerst die Material-liste mit Ihrem Paketinhalt! Bitte haben Sie Verständnis, dass Beanstandungen nur im nicht aufgebauten Zustand bearbeitet werden können!

 First compare the list of materials with your package contents! Please understand that complaints can be processed in the non-built status only!

 Commencez par comparer la liste du matériel avec le contenu de votre paquet! Sachez que nous traitons uniquement les réclamations concernant le matériel à l'état non monté!

 Vergelijk eerst de lijst van materialen met de inhoud van uw pakket! Reclamaties kunnen alleen in behandeling worden genomen zolang de onderdelen nog niet zijn gemonteerd!

 Start med at kontrollere materialelisten med indholdet af den leverede pakke! Vi gør venligst opmærksom på at reklamationer kun kan behandles for materialer som ikke er blevet bearbejdet!

 En primer lugar, compare la lista de material con el contenido del paquete. Rogamos entienda que las reclamaciones sólo pueden ser tramitadas antes de montar el objeto!

 Confrontate questa distinta materiali prima con il contenuto del pacchetto! Vi preghiamo di comprendere che eventuali reclami possono essere accolti solo prima del montaggio!

 Nejprve přezkontrolujte obsah balení podle materiálového listu! Mějte pochopení pro to, že případnou reklamaci se můžeme zabývat pouze tehdy, když díly nebudou smontované! Za pomoci tohoto seznamu můžete jednotlivé díly přiřadit k montážnímu návodu.

 Najprej primerajte zoznam materialov z vsebino vašega paketa! Upoštevajte, da lahko pritožbe obravnavamo le v nesestavljenem stanju!

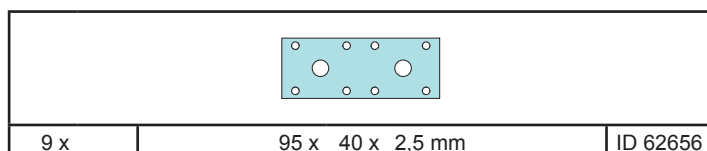
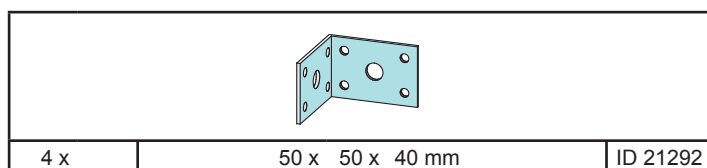
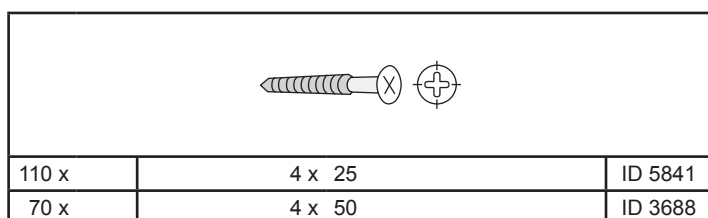
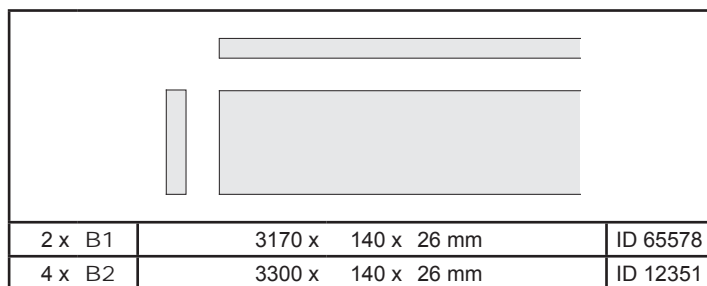
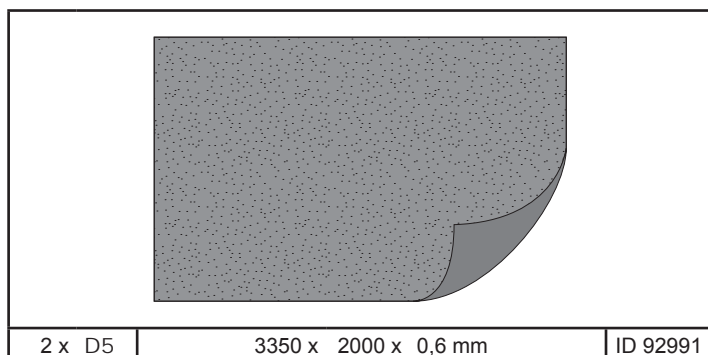
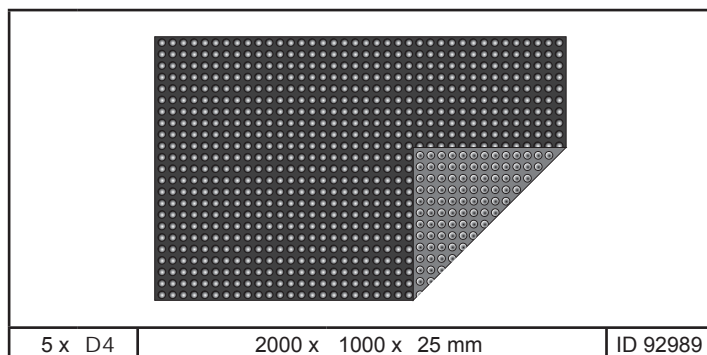
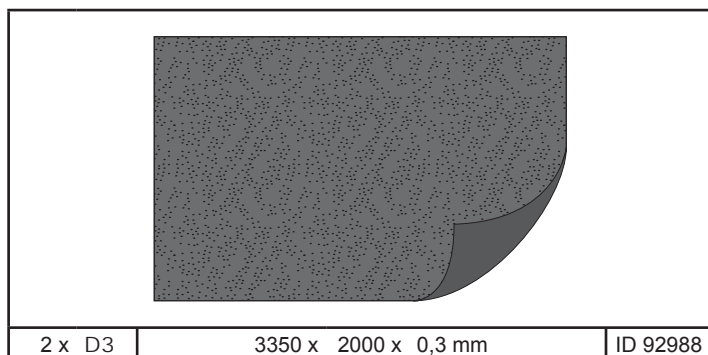
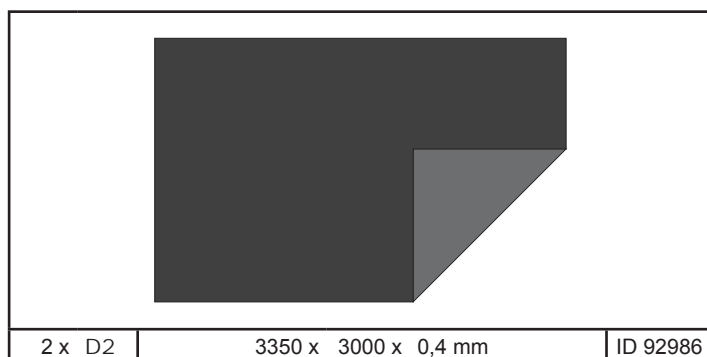
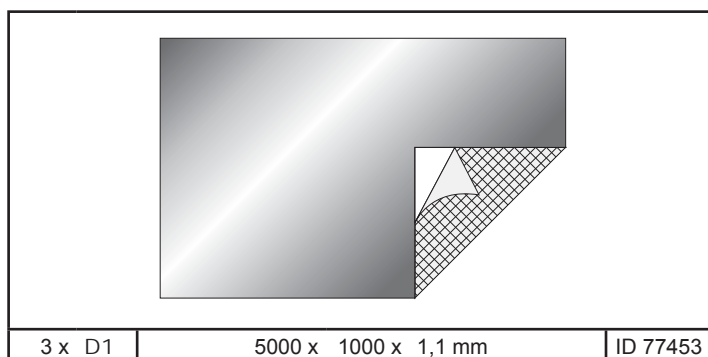
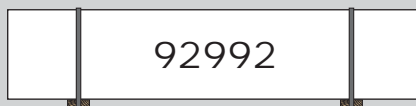

Übersicht  
Overview  
enquête

overzicht  
undersøgelse  
estudio

sondaggio  
přehled

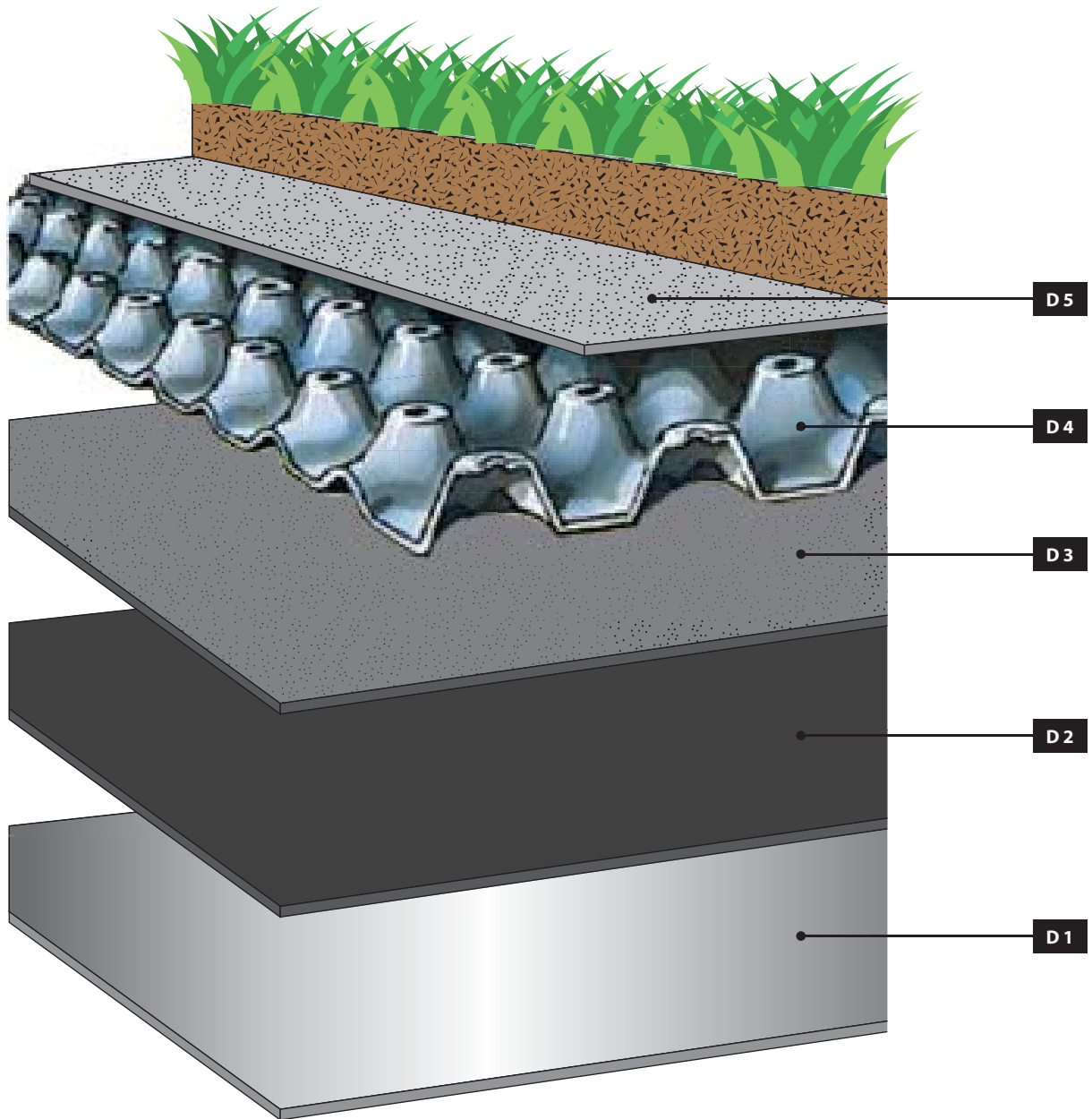

9x

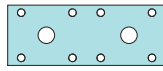

72x

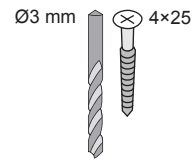

2 x

**B 1**

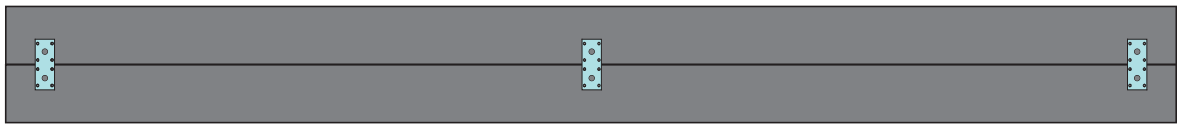

2 x

**B 2**

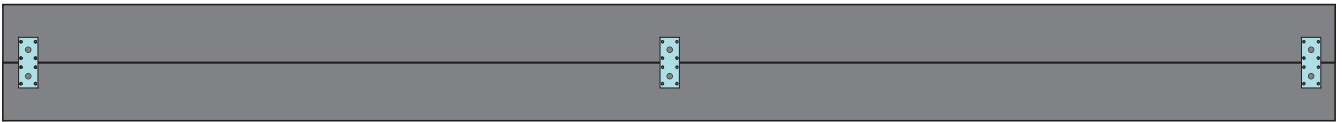

2 x

**B 2**

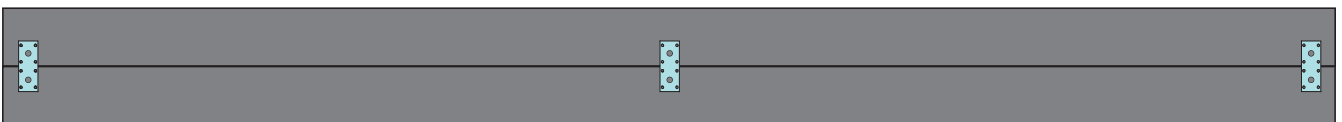

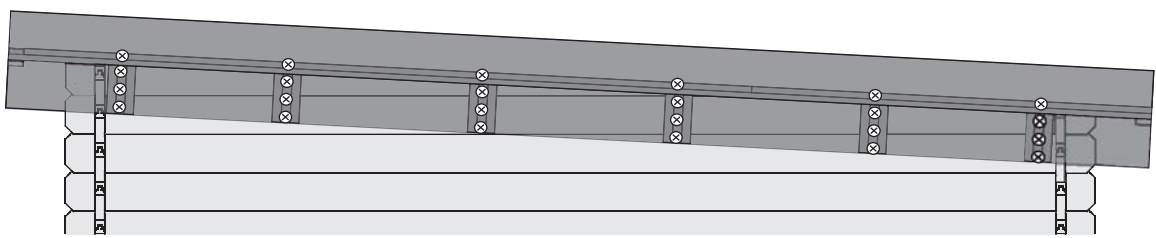
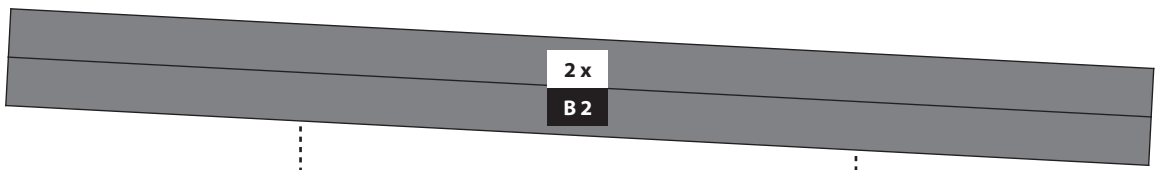
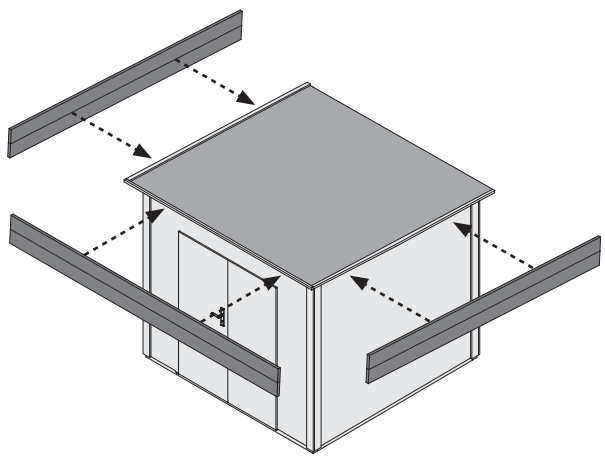
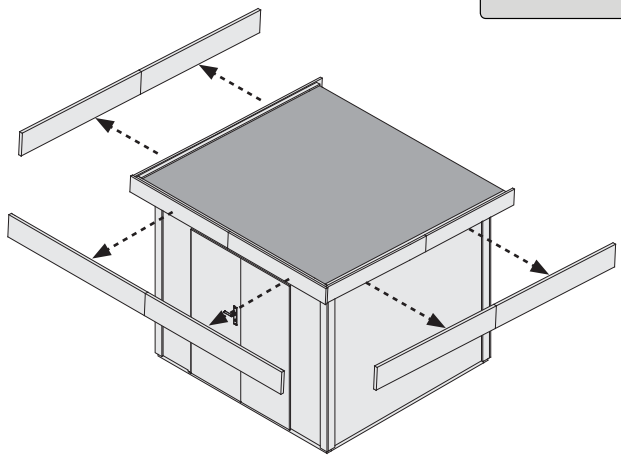

68x

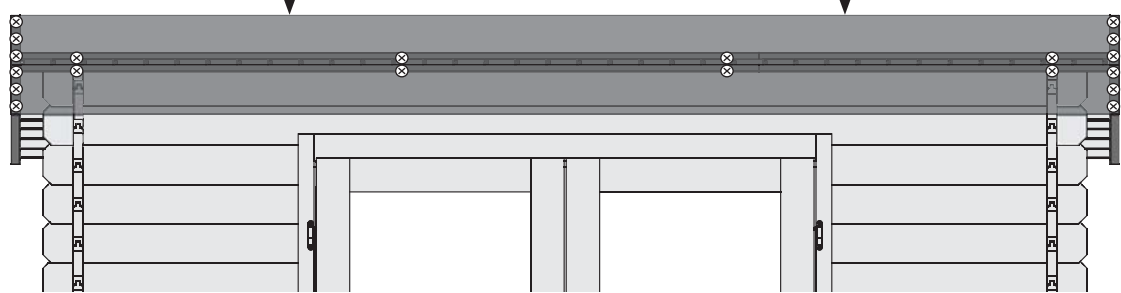
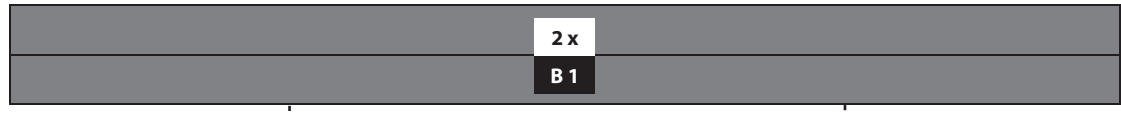
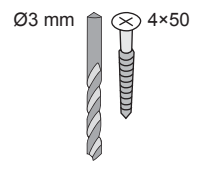

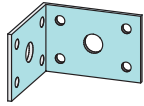

4x

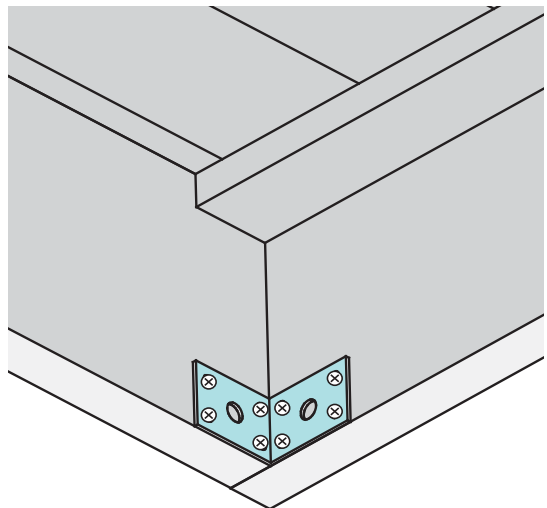
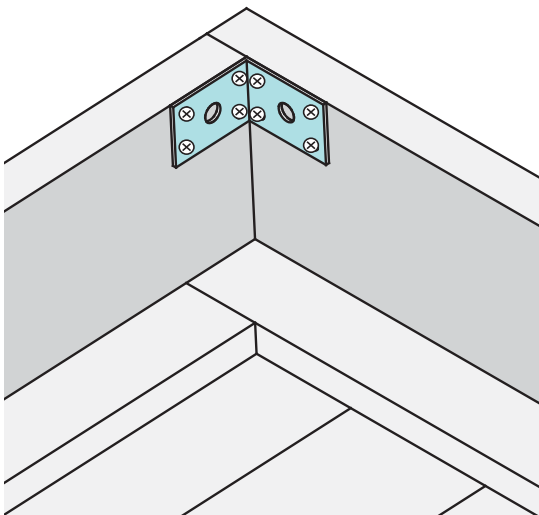
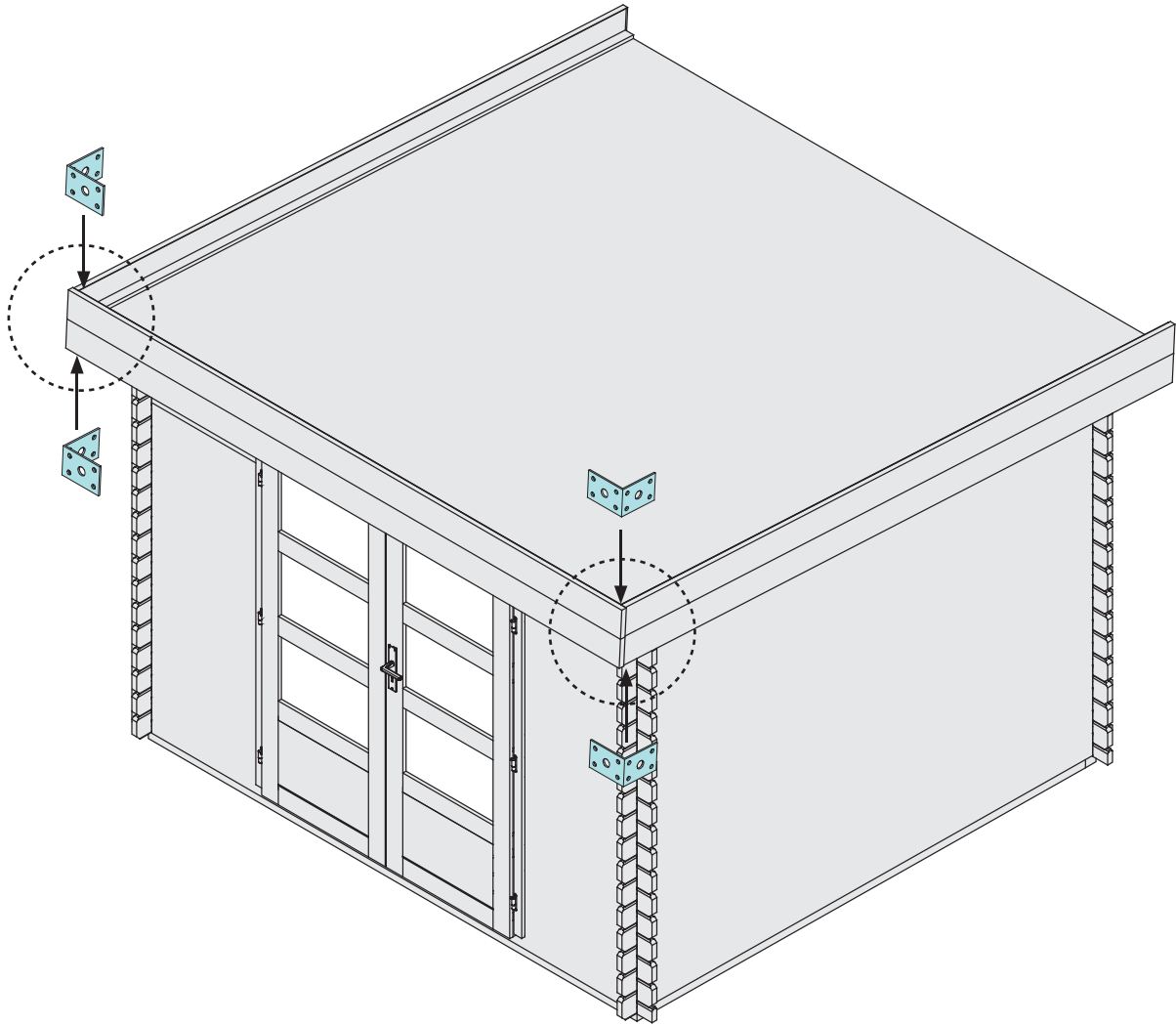
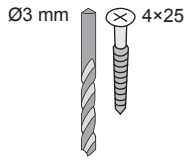

32x





 Das Dach muss sauber und trocken sein!

 The roof must be clean and dry!

 Le toit doit être propre et sec!

 Het dak moet schoon en droog zijn!

 Taget skal være rent og tørt!

 ¡El techo debe estar limpio y seco!

 Il tetto deve essere pulito e asciutto!

 Střecha musí být čistá a suchá!

 Zuschneiden

 Cut out

 Découper

 Uitknippen

 Skåret ud

 Cortar

 Ritagliare

 Vystřihnout

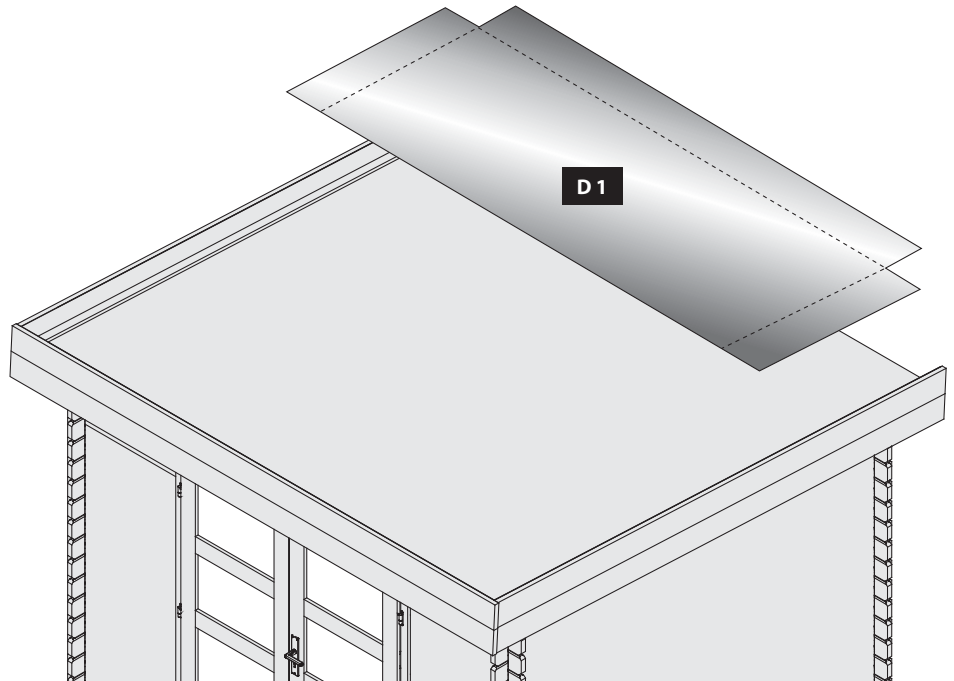
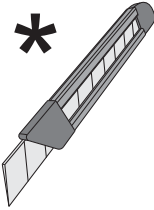



 Fest verkleben. Beginnend hinten. ≈ 100 mm Überlappung der Folie

 Stick firmly. Starting at the back. ≈ 100 mm overlap of the film

 Collez fermement. Partir à l'arrière. ≈ Coverage couverture du film de 100 mm

 Blijf stevig plakken. Beginnend aan de achterkant. ≈ 100 mm dekking van de film

 Hold fast. Fra bagsiden. ≈ 100 mm overlaping af filmen

 Mantente firme. Comenzando por la parte de atrás. ≈ Coverage 100 mm de cobertura de la película

 Stick saldamente. A partire dal retro. ≈ 100 mm di copertura del film

 Pevně se držte. Začíná vzadu. ≈ Coverage 100 mm pokrytí filmu

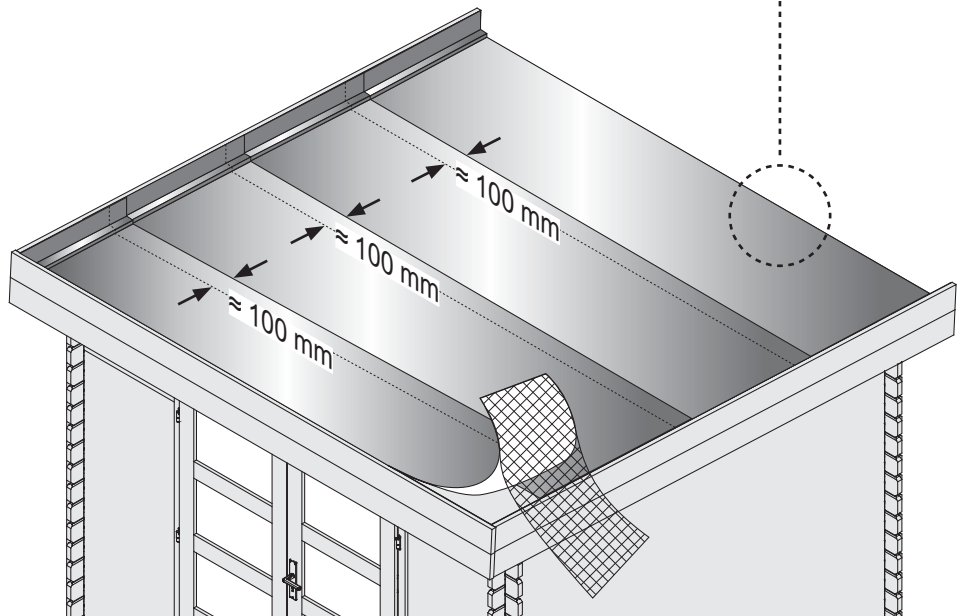
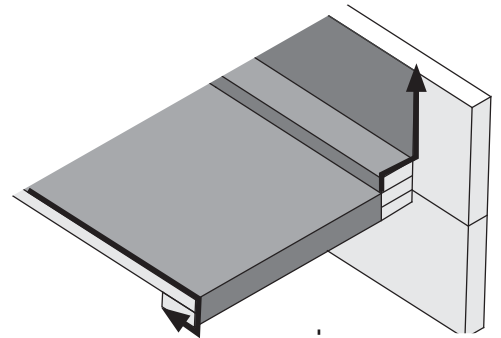



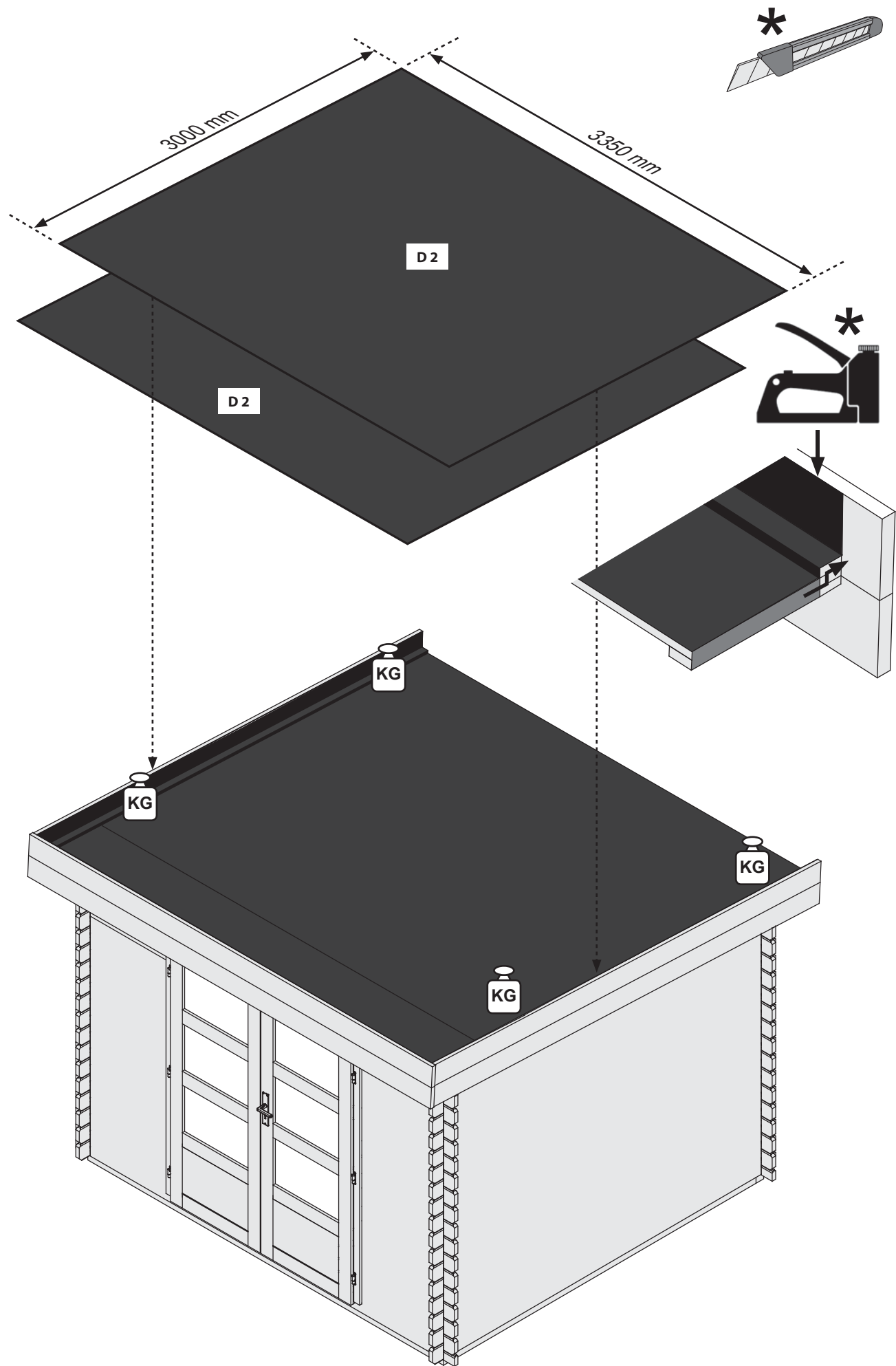

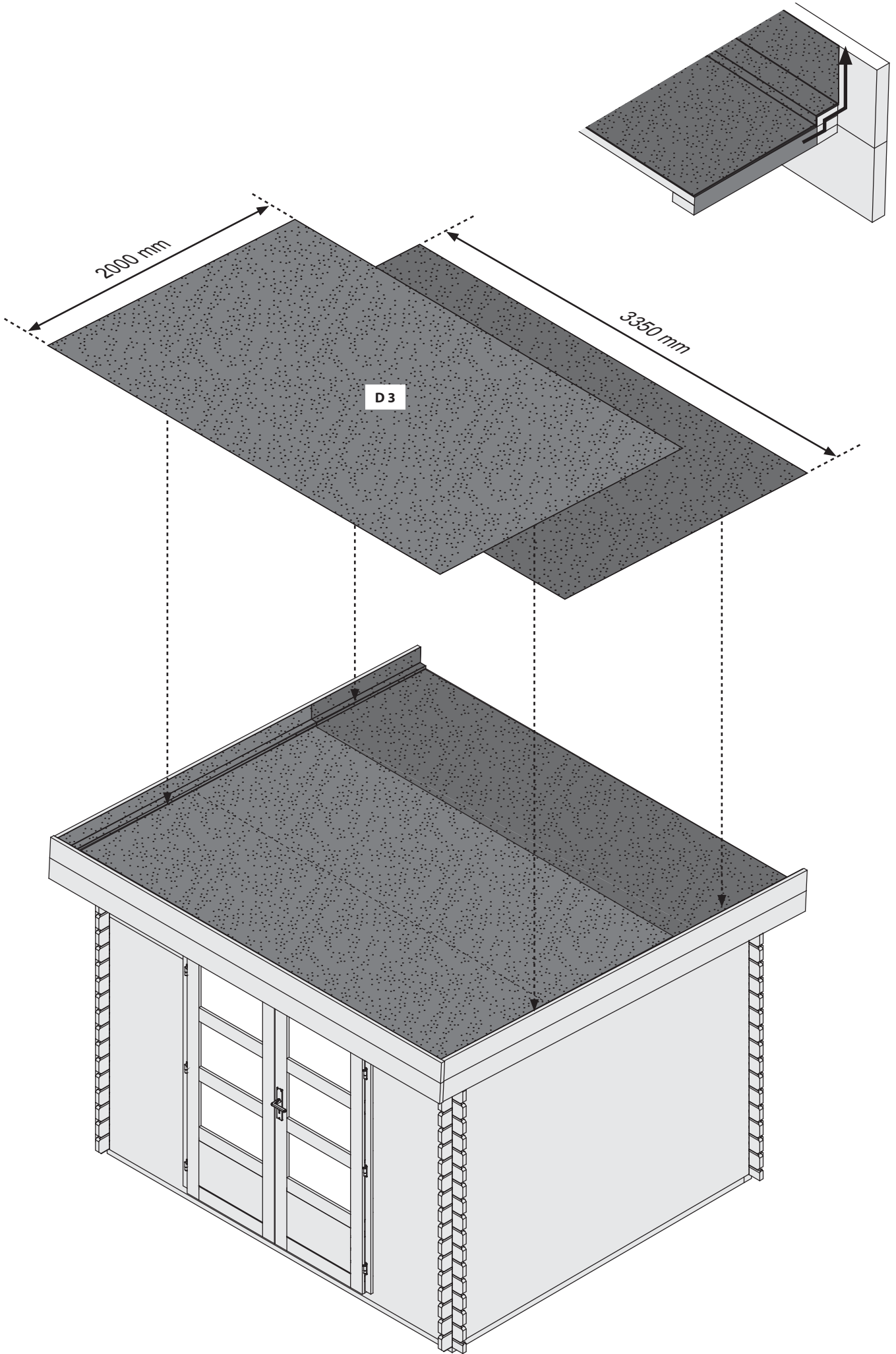

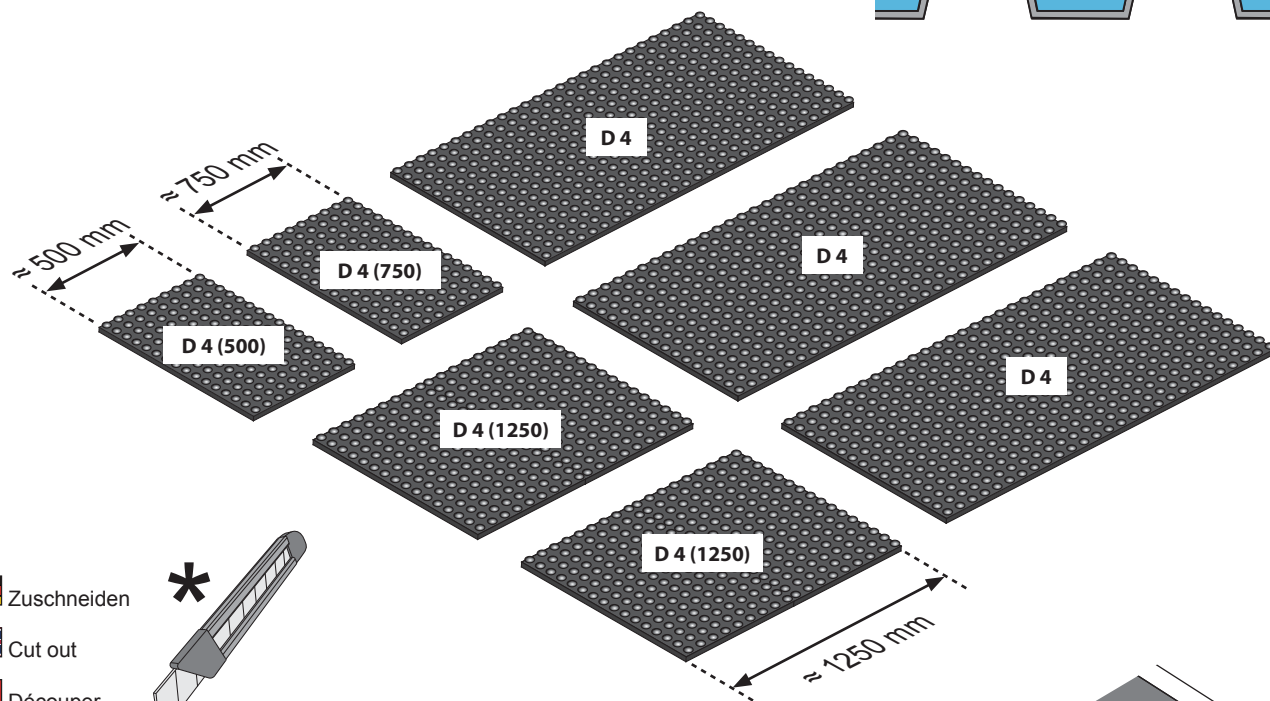

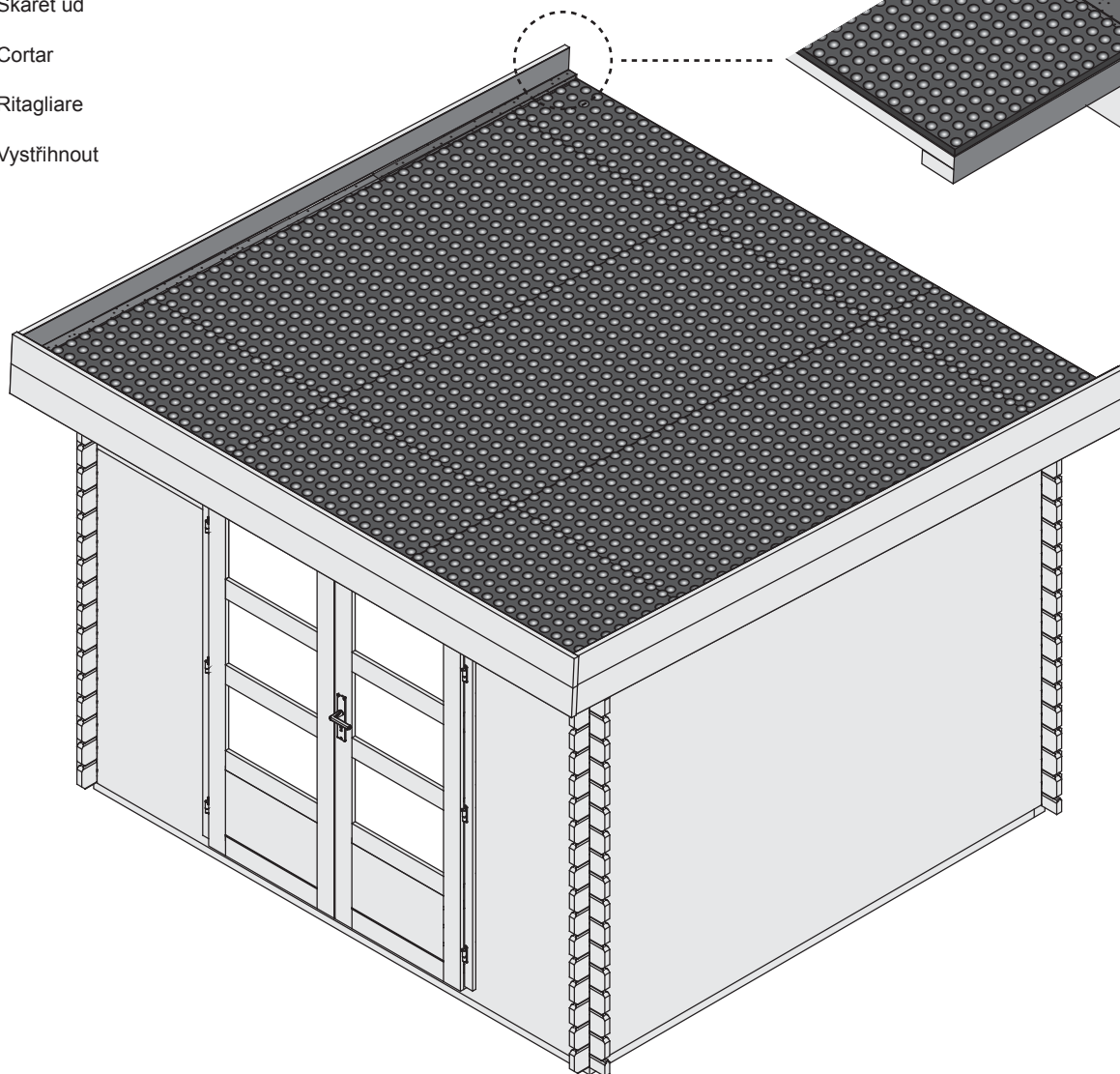
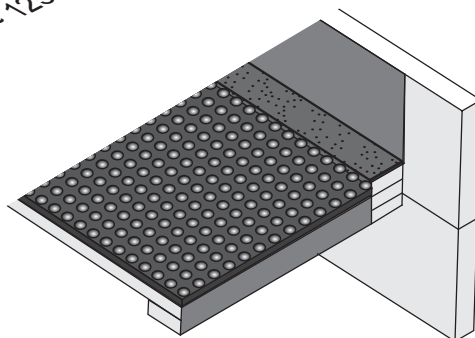
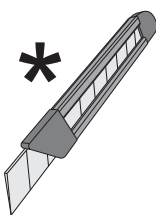

-  Zuschneiden
-  Cut out
-  Découper
-  Uitknippen
-  Skåret ud
-  Cortar
-  Ritagliare
-  Vystřihnout

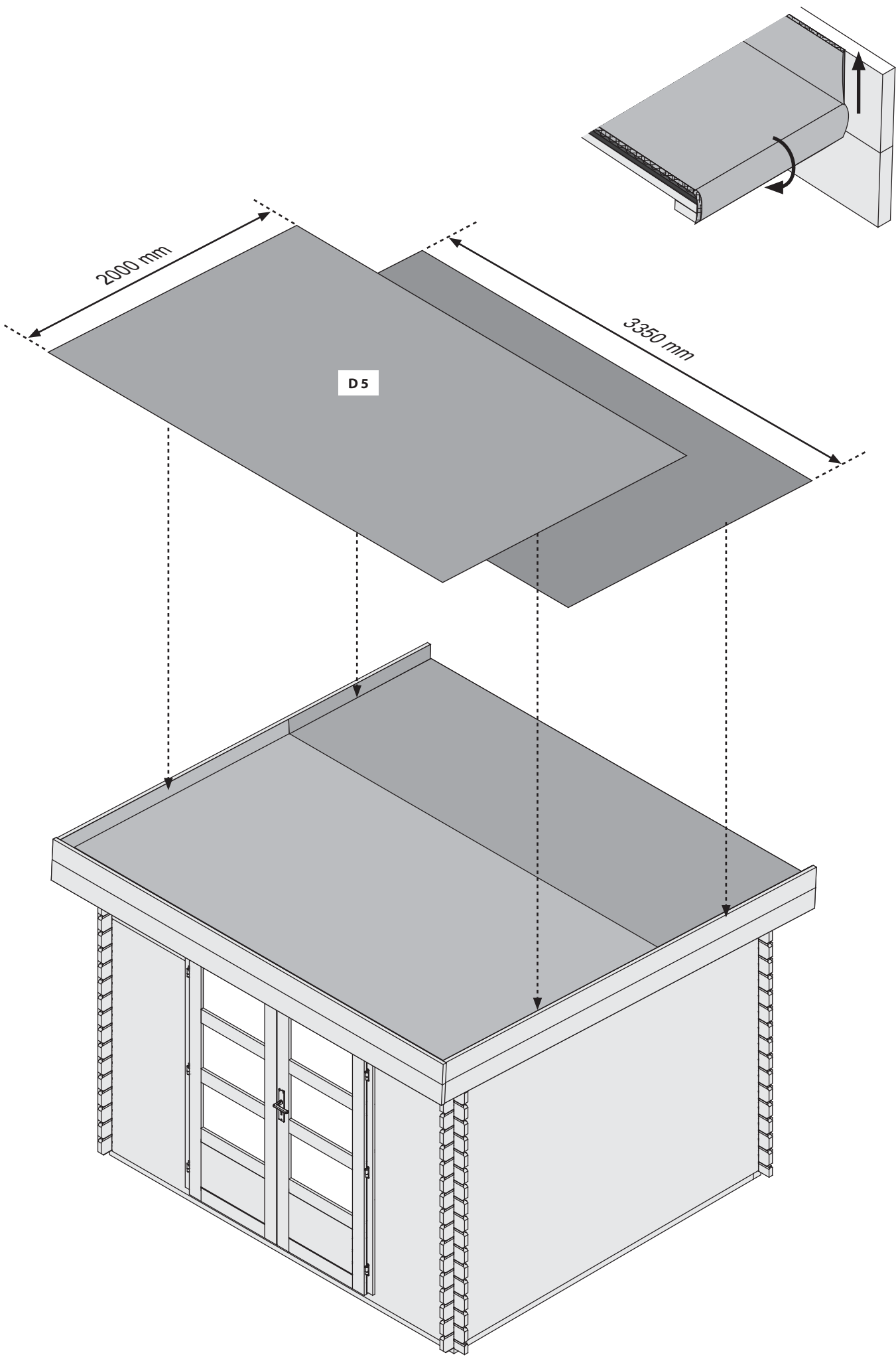





 Nicht im Lieferumfang enthalten

 Niet bijgeleverd

 V ceně není zahrnuto

 Not included

 No forman parte del suministro

 Ikke inkluderet

 Non comprises dans la livraison

 Non incluso

