

# Technische Daten

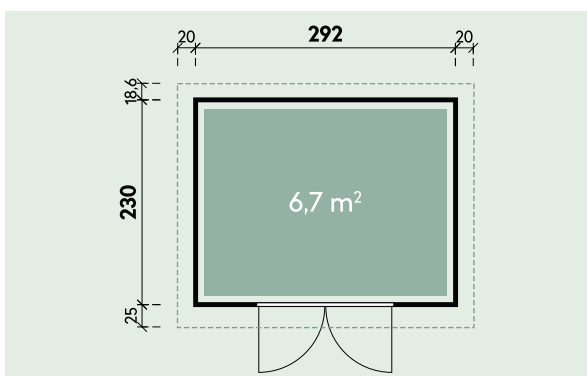

## Artikelnummer:

828 210 | 850 211 | 850 212





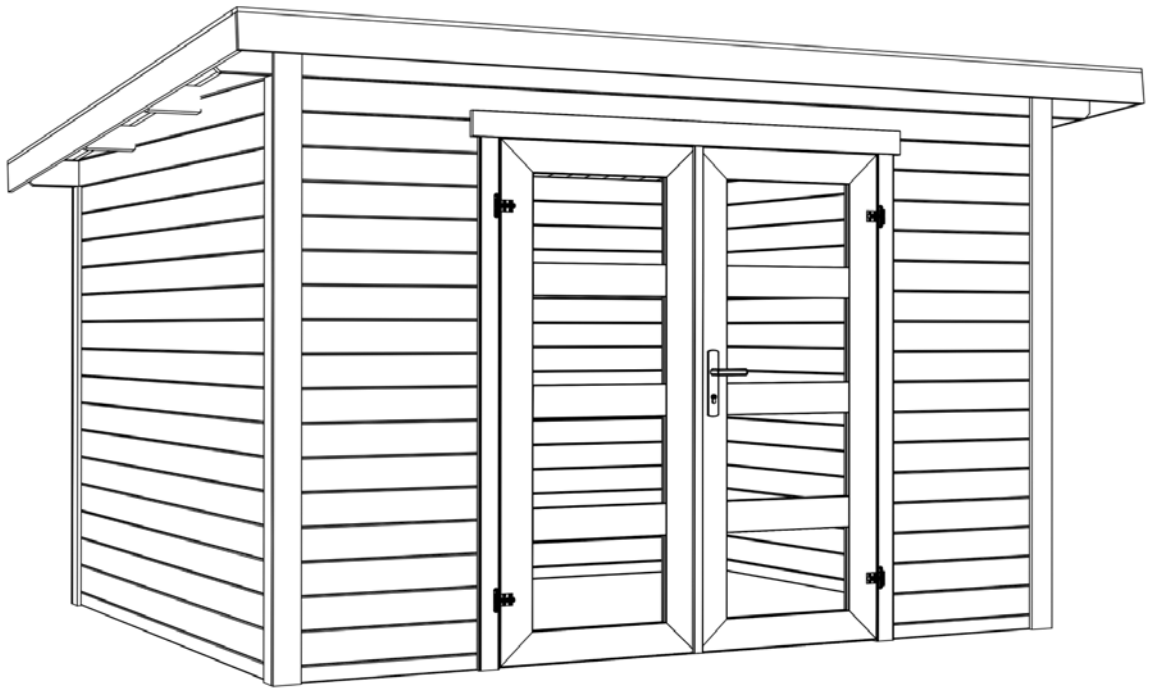



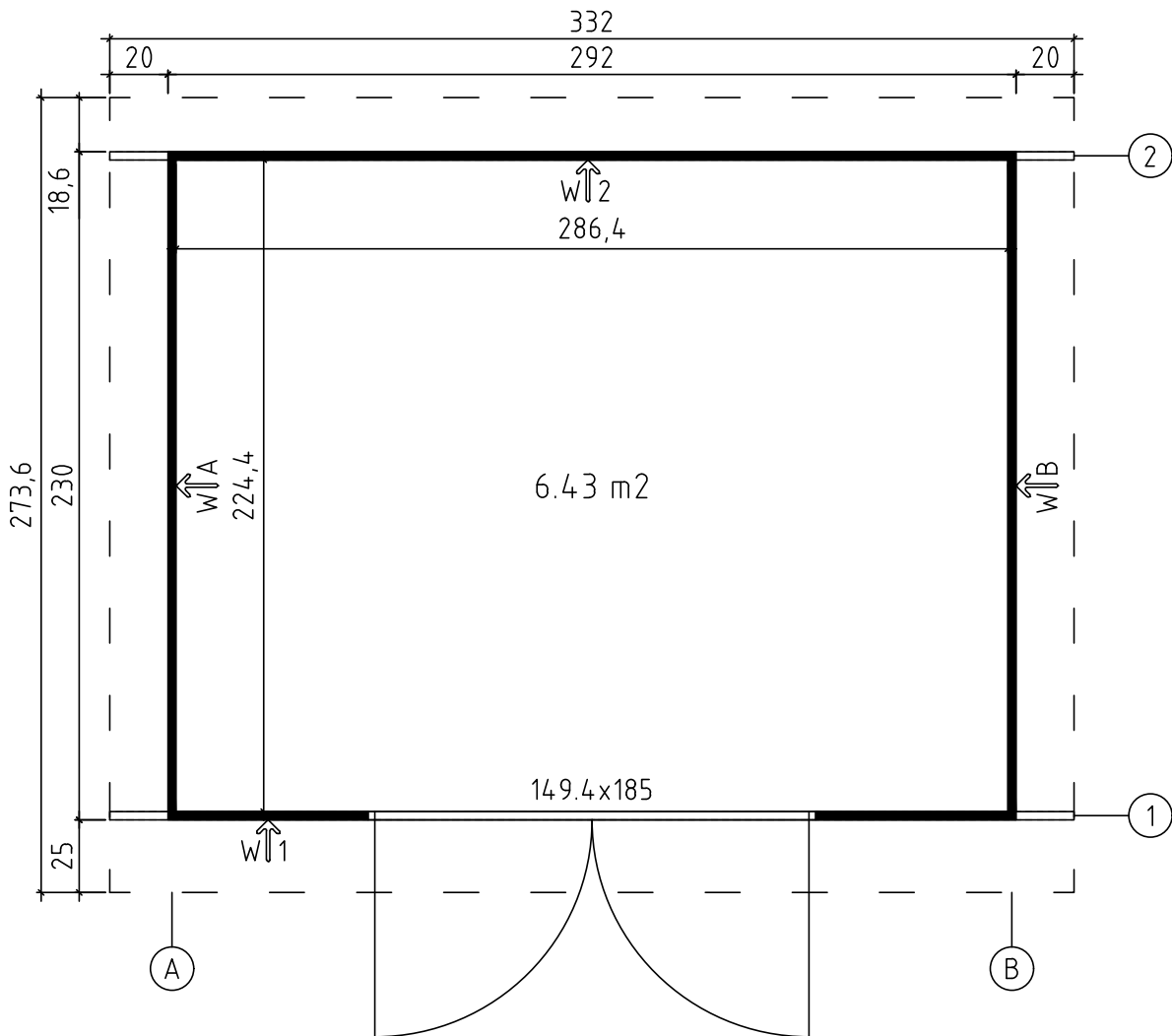







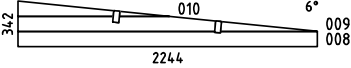
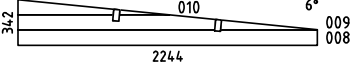
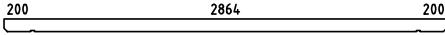
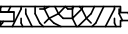

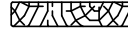
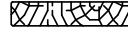
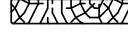
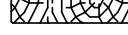

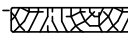
**Kontrolliert durch:**





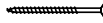
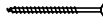
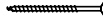
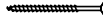
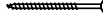
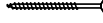
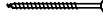
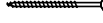





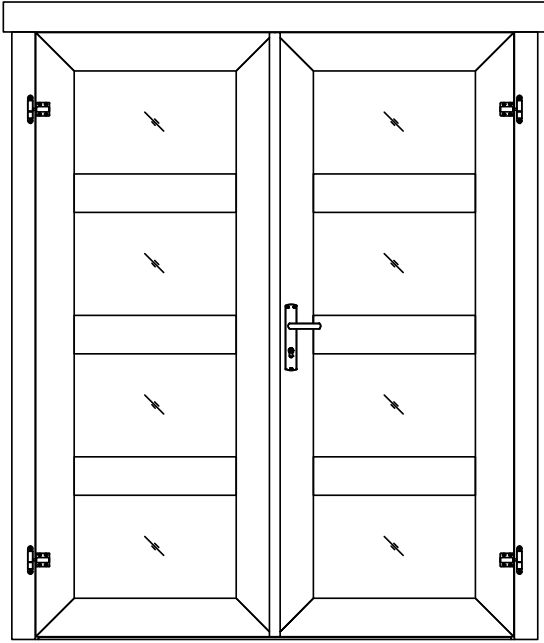
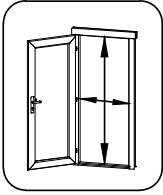





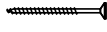
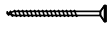

Grundplan - Grundplan - Plan de masse -  
Planimetria - Plattegrond - Põhiplaan

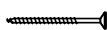
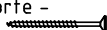

Pos	25.09.2023 Piece list - Stückliste - Liste des pièces - Elementi - Stuklijst - Tükítabel 5/6	Q	P (mm)	L (mm)
001		2	28x57	690
002		32	28x114	690
003 13257		16	28x114	2920
004		2	28x114	3320
005		1	28x57	2920
006		2	28x57	2244
007		30	28x114	2244
WA-1		1		
WB-1		1		
A-PR1	Roof beam - Dachbalken - Panne de toit - Perlina del tetto - Gordingen / dakbalk - Pärlin 	2	44x95	3320
RB-1	Roof boards - Dachbretter - Voliges - Perlina per tetto - Dakhout - Katuselaud 	37	90x15.5	2750
DPL-1 33603	Roofing felt fillet - Dachpappenleiste - Baguette de fixation du feutre bitumeux - Asse per fissaggio guaina bituminosa - Afdekljst asfaltpapier - Katusepapiilist 	2	15x45	2770
DPL-2 23452	Roofing felt fillet - Dachpappenleiste - Baguette de fixation du feutre bitumeux - Asse per fissaggio guaina bituminosa - Afdekljst asfaltpapier - Katusepapiilist 	1	15x45	3350
TBE7-1 39886	Corner fillet - Deckleiste - Profils de finition angles a l'exterieur - Massello d'angolo - (hoek)lijst - Nurgaliist 	2	15x70	1767
TBE7-2 39988	Corner fillet - Deckleiste - Profils de finition angles a l'exterieur - Massello d'angolo - (hoek)lijst - Nurgaliist 	2	15x70	1995
TBE6-1 39989	Corner fillet - Deckleiste - Profils de finition angles a l'exterieur - Massello d'angolo - (hoek)lijst - Nurgaliist 	2	15x90	1881
TBE6-2 41636	Corner fillet - Deckleiste - Profils de finition angles a l'exterieur - Massello d'angolo - (hoek)lijst - Nurgaliist 	2	15x90	2109
P1-1	Post - Pfosten - Poteau - Piede registrabile - Stijl - Post 	2	55x55	1880
P1-2 46411	Post - Pfosten - Poteau - Piede registrabile - Stijl - Post 	2	55x55	2100
TB3-1 39990	Fascia board - Traufbrett - Bandeau de toit - Finitura lati tetto - Gevellijst - Räästalaud 	2	15x120	2800
TB3-2	Fascia board - Traufbrett - Bandeau de toit - Finitura lati tetto - Gevellijst - Räästalaud 	1	15x120	3350
TB1-1 26838	Fascia board - Traufbrett - Bandeau de toit - Finitura lati tetto - Gevellijst - Räästalaud 	1	15x45	3320
DRV-1 22614	Roof edge reinforcement - Dachrandverstärkung - Corniere de renfort de bord de toit - Rinforzo x tetto - Dakrand versterking - Räästatugevdus 	1	28x34	3320

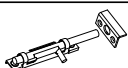
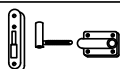
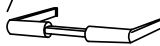
Pos	Piece list - Stückliste - Liste des pièces - Elementi - Stuklijst - Tükítábel	6/6	Q	P (mm)	L (mm)
TBL3-1 23522	Fixing fillet - Fixierungsleiste - Profil de fixation - Massello di fissaggio - Bevestiging lijstwerk - Tenderlijst		2	18x28	1850
HS8 5105	Screw for corner fillet - Schraube zur Befestigung deckleiste - Vis pour profils de finition angles a l'extérieur - Viti per massellino d'angolo - Schroef voor afdeklijst (hoek) - Kruvi nurgaliistudele		48	3,5x35	
HS4 5102	Screw for fascia boards - Schrauben für Traufbretter - Vis pour fixation bandeau de toit - Viti x striscia del tetto - Schroef voor gevellijst - Kruvi räästalaualae		6	3x30	
HS12 5109	Screw for fascia boards - Schrauben für Traufbretter - Vis pour fixation bandeau de toit - Viti x striscia del tetto - Schroef voor gevellijst - Kruvi räästalaualae		22	4x40	
HS12 5109	Screw for roof edge reinforcement - Schrauben für Dachrandverstärkung - Vis pour fixation corniere renfort de bord de toit - Viti x rinforzo bordo tetto - Schroef voor dakrand versterking - Kruvi räästatugevdusele		6	4x40	
HS12 5109	Screw for fixing fillet of door and window - Schrauben für Fixierungsleiste - Vis pour profil vertical de fixation pour ouvertures des fenêtrés et portes - Viti per massello di fissaggio - Schroeven voor bevestiging van deur en raam lijsten - Kruvi tenderlijstudele		36	4x40	
HS13 5110	Screw for wall details - Schraube für Wand details - Vis pour mur details - Viti per elementi della porta - Schroef voor wand details - Kruvi seinadetailite		300	4x60	
HS18 5113	Screw for gable - Schrauben für Giebel - Vis pour fixation des pignons - Viti per timpano - Schroef voor gevelpunt - Kruvi kelba kinnitamiseks		4	5x120	
HS18 5113	Screw for roof beams - Schrauben für Dachbalken - Vis pour fixation pannes de toit - Viti per perline del tetto - Schroef voor gordingen / dakbalken - Kruvi pärlinitele		4	5x120	
SH28 32509	Hammer block - Schlagholz - Calle de frappe - Blocco di legno da usare come cuscinetto quando si usa il martello - Slagkloss - Löögiklots		1		
NF4 5137	Zn nail for roof - Zn Nägel für Dachbretter - Pointe pour fixation voliges de toit - Chiodi x perline tetto - Spijker(nagel) voor dakhout - Nael katuselauale		150	2x50	
NF5 5145	Zn nail for roofing felt fillet - Zn Nägel für Dachpappenleiste - Pointe pour baguette de fixation feutre bitumeux - Chiodi x carta bituminosa x tetto - Spijker(nagel) voor asfaltpapier afdeklijst - Papilistunael		16	2x40	
34579	Door - Tür - Porte - Porte - Deur - Uks 1494x1850 TUK.4.020.SVP.MMX28 SGA+28		1		

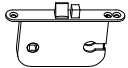
Pos	Piece list - Stückliste - Liste des pièces - Elementi - Stuklijst - Tükitalabel 14.94x1850 TUK.4.020.SVP.MMX28 SGA+28	1/2	Q	P (mm)	L (mm)
	<p>Glass size - Glasgröße - Taille de la vitre - Misura del vetro - Glas afmeting - Klaasi mõõt: 502x325 mm</p>   <p>1418x1792 mm</p>				
1	Upper door jamb - Türrahmen oben - Cadre de porte supérieur - Telaio superiore della porta - Bovendorpel - Ukse ülemine leng		1	66x100	1438
2	Left door jamb - Türrahmen links - Cadre de porte gauche - Telaio montante sinistro della porta - Linkerstijl deurframe - Ukse vasak leng		1	66x80	1850
3	Right door jamb - Türrahmen rechts - Cadre de porte droit - Telaio montante destro della porta - Rechterstijl deurframe - Ukse parem leng		1	66x80	1850
4	Doorstep - Swelle - Barre de seuil - Soglia della porta - Deurdorpel - Lävepak		1	20x21	1418
5	Connection strip - Deckleiste - Baguette de battement - Profilo verticale della porta - Stulplijst - kokkuvaltšiliist		1	13x32	1812

Pos	18.12.2017	Piece list - Stückliste - Liste des pièces - Elementi - Stuklijst - Tükitabel 1494x1850 TUK.4.020.SVP.MMX28 SGA+28	2/2	Q	P (mm)	L (mm)
HS9		Screw for fixing door to the wall - Schraube zur Befestigung für - zarge mit wand - Vis de fixation partie basse dormants de porte au 1er rang de madrier - Viti per fissare la porta alla parete - Schroef voor bevestiging deur naar wand - Kruvi ukseleugi kinnitamiseks seinale		2	3.5x50	
HS25		Screw for doorstep - Schrauben für swelle - Vis pour fixation barre de seuil - Vite per soglia della porta - Schroef voor deurdorpel - Kruvi lävepakule		3	4.5x65	
HS4		Screw for door fillet - Schraube zur Befestigung türleiste - Vis pour fixation baguette d'arret de porte - Viti per massellino della porta - Schroef voor deurlijst - Kruvi ukse kokkuvaltšiliistule		5	3x30	
HS10		Screw for door lock - Schrauben für türschloss - Vis de fixation serrure - Viti per serratura della porta - Schroef voor deurslot - Kruvi ukse lukule		2	4x25	
HS10		Screw for striker plate - Schraube für halteplatte - Vis de fixation gache de porte - Vite per cerniera a piastra - Schroef voor slotplaat - Kruvi luku vasturauale		2	4x25	
HS11		Screw for fixing bolt hinge - Schraube für türband - Vis pour fixation gonds de porte - pour ouvrant - Viti per fissaggio cardini e cerniere della porta - Schroef voor scharnier - Kruvi ukse polthingele		16	4x30	
HS12		Screw for fixing bolt hinge - Schraube für türband - Vis pour fixation gonds de porte - pour ouvrant - Viti per fissaggio cardini e cerniere della porta - Schroef voor scharnier - Kruvi ukse polthingele		12	4x40	
HS13		Screw for door jamb - Schraube für türrahmen - Vis de fixation partie haute avec montants du cadre de porte - Viti x fissaggio montanti porte - Schroef voor deurkozijn - Kruvi ukse lengile		2	4x60	
HS16		Screw for door jamb - Schraube für türrahmen - Vis de fixation partie haute avec montants du cadre de porte - Viti x fissaggio montanti porte - Schroef voor deurkozijn - Kruvi ukse lengile		2	5x90	
TL		Latch bolt for double door - Türriegel - Loquet pour double porte - Scrocco per porta doppia - Nachtslot - Riiv		2		
BH		Male bolt hinge for door - Türband - Partie male de paumelle de porte - Cerniera anube x porta - Scharnier bout - Polthing adapteriga DIN15-57		4		
TL4		Door handle fittings - Türgriff - Poignee de porte - Maniglie - Deurhendel / klink - Ukse käepide		1		
TL5		Set of door lock covers - Schlossblenden - Set de garnitures de porte - Copertura serrature - Slot sluitplaat set - Ukse lukuplaat		1		
CL		Cylinder lock - Zylinderschloss - Barillet de porte - Serratura - Cylinder slot - Ukse lukusüdamik		1	30x30	
DL		Door lock - Türschloss - Serrure de porte - Serratura - Deur slot - Ukse lukk		1		
SFL		Stricker for lock - Schließblech für türschloss - Gache de porte - L'attaccante piastra - Sluitplaat voor deurslot - Ukse vasturaud		1		

