













Mehr Produkte finden Sie  
in unserem Katalog!

Art.-Nr. 830 852

#### DIMENSIONEN

	Bohlenstärke	34 mm
	Innenmaß	293 x 233 cm
	Sockelmaß	580 x 240 cm
	Gesamtmaß	630 x 300 cm
	Grundfläche	13,9 m <sup>2</sup>
	Seitendach	130 cm
	Rauminhalt	28 m <sup>3</sup>
	Seitenwandhöhe v/h	217/202 cm
	Dachüberstand umlaufend	30 cm
	Dachneigung	4 °
	Dachfläche	18,9 m <sup>2</sup>
	Dachbretter inkl. Dachpappe	18 mm
	Fußboden	18 mm

# Emelie 5824 mit Seitendach Typ 2 Bernstein



34 mm | 580 x 240 cm | 13,9 m<sup>2</sup>

**5** JAHRE  
GARANTIE





Farbbehandlung Gletschergrau

Die UVP-Preise finden Sie in der Preisliste oder unter:  
[www.finnhaus.de/downloads.php](http://www.finnhaus.de/downloads.php)

#### TÜREN & FENSTER

	Doppeltür (Halbglas)	145 x 187 cm
--	----------------------	--------------

#### VERPACKUNG

	Paketmaß	
	Paket 1	407 x 117 x 60 cm
	Paket 2	200 x 100 x 20 cm
	Paket 3	310 x 120 x 22 cm
	Gesamtgewicht	935 kg

#### ZUBEHÖR

4 Rollen Dichtungsbahnen  
**Dachrinne**  
Kunststoff 404Ax anthrazit  
Alu bis 800 cm  
mit 1 Fallrohr

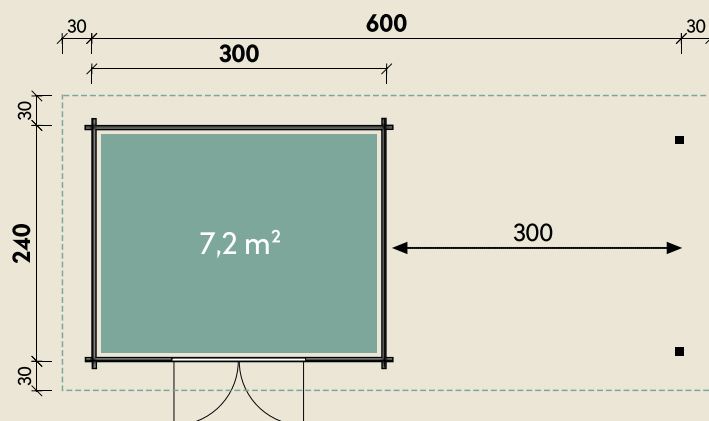

Alle Preise sind empfohlene Verkaufspreise inklusive der gesetzlichen MwSt.  
Weitere Informationen finden Sie unter: [www.finnhaus.de](http://www.finnhaus.de) oder im aktuellen Katalog.  
Technische Änderungen, Druckfehler und Irrtümer vorbehalten.