

AUFBAUANLEITUNG

„Bodenplatte“

Für die Gerätehäuser „HighLine“, „AvantGarde“, „Panorama“, „NEO“ und „Europa“, sowie für den „Geräteschrank“ und die „MiniGarage“

- Ⓜ GB Assembly manual “Floor plate”
- Ⓜ FR Notice de montage “Plaque de fond”
- Ⓜ NL Opbouwbeschrijving “Grondschroef-fundament”
- Ⓜ ES Instrucciones de montaje “Cimientos atornillados”
- Ⓜ IT Istruzioni di montaggio “Fondazione con viti di ancoraggio a terra”
- Ⓜ DK Monteringsvejledning “Bundplade”

For further languages please go to: www.biohort.com/downloads

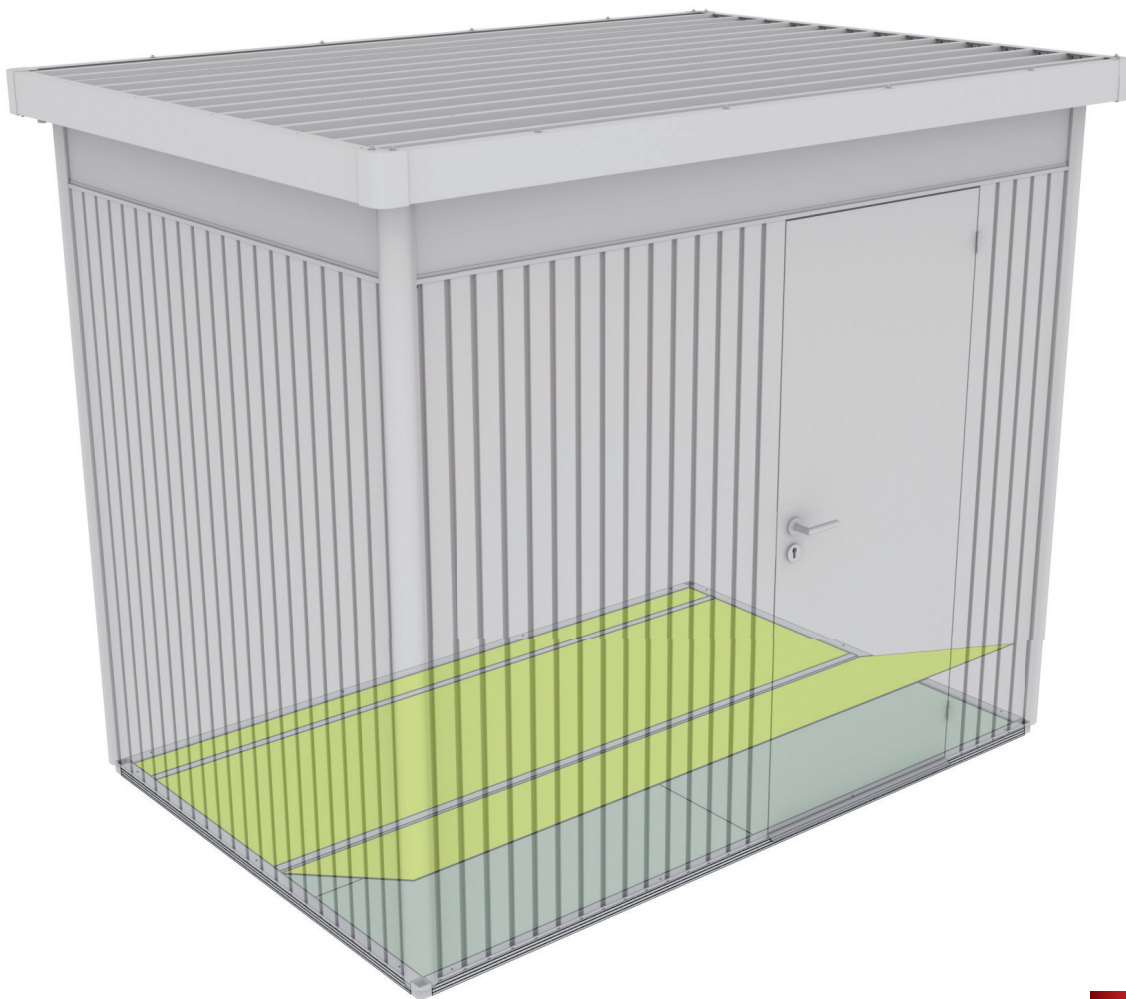

QUALITÄT AUS
ÖSTERREICH



Wichtige Punkte für den Aufbau!

Vorliegende Aufbauanleitung zeigt den Zusammenbau der „Alu-Bodenplatten“ für das Gerätehaus „HighLine“. Sie gilt sinngemäß auch für die Gerätehäuser „AvantGarde“, „Europa“, „Panorama“, „NEO“, sowie für den „Geräteschrank“ und die „MiniGarage“.

- (GB)** *Important details regarding assembly! This assembly manual shows the erecting of the “Alu Floor Panels” for the garden shed “HighLine”. It is also valid for the garden sheds “AvantGarde”, “Europa”, “Panorama”, “NEO” as well as for the “Equipment Locker” and the “MiniGarage”.*
- (FR)** *Points importants lors du montage! Cette notice montre l'assemblage de la « plaque de fond en aluminium » pour l'abri de jardin « HighLine ». Elle s'applique aussi aux abris de jardin « AvantGarde », « Panorama », « NEO », à l'armoire à outils et au « MiniGarage ».*
- (NL)** *Belangrijke punten voor de montage! Deze opbouwbeschrijving toont de montage van de “ALU bodemplaten” voor de berging “HighLine”. Die geldt ook voor de bergingen “AvantGarde”, “Europa”, “Panorama”, “NEO” en voor de “Tuinkast” en “MiniGarage”.*
- (ES)** *Notas importantes para el montaje: En las instrucciones se muestra el montaje de las placas de suelo de aluminio para las casetas “HighLine”. Son válidas también para las casetas “AvantGarde”, “Europa”, “Panorama” y “NEO” así como para el “armario de jardín” y el MiniGarage”.*
- (IT)** *Indicazioni importanti per il montaggio! Le istruzioni di montaggio fanno vedere l'assemblaggio del “Telaio perimetrale in alluminio” per la casetta portattrezzi “HighLine”. Queste istruzioni di montaggio valgono in modo analogo per le casette portattrezzi “AvantGarde”, “Europa”, “Panorama”, “NEO”, e anche per l’“Armadio per attrezzi” e per la “MiniGarage”.*
- (DK)** *Vigtig information til montage! Denne vejledning viser montage af “Alu-gulvpaneler” for “HighLine” Redskabsrumet. Vejledningen er også gældende for øvrige modeller redskabsrum ”AvantGarde”, ”Europa”, ”Panorama”, ”NEO”, samt for ”Redskabsrum” og ”MiniGarage”.*



Wasserwaagen - Symbol:

Betreffendes Einbauteil mit der Wasserwaage ausrichten.

- (GB)** *Symbol of spirit level: Align the respective parts by using the spirit level.*
- (FR)** *Symbole niveau à bulle: Lorsque ce symbole apparaît, vous devez ajuster l'élément à l'aide d'un niveau à bulle.*
- (NL)** *Waterpas - symbol: Bij montageschappen waar dit symbool bijstaat is het noodzakelijk het betreffende onderdeel waterpas in te bouwen.*
- (ES)** *Símbolo del nivelador: Indica que se debe ajustar y centrar la pieza con la ayuda de un nivelador.*
- (IT)** *Simbolo di livella a bolla d'aria: Allineare il componente in questione con l'ausilio di una livella a bolla d'aria.*
- (DK)** *Symbol for vaterpas: Juster de respektive dele ved hjælp af vaterpas.*

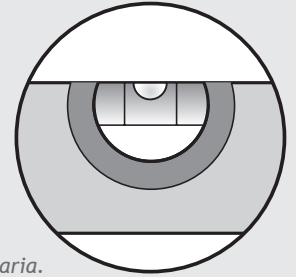

Verwenden Sie bei der Montage Arbeitshandschuhe!

- (GB)** *Wear working gloves!*
- (FR)** *Portez des gants de travail!*
- (NL)** *Handschoenen gebruiken!*
- (ES)** *Utilice unos guantes de trabajo.*
- (IT)** *Utilizzare guanti da lavoro!*
- (DK)** *Brug arbejdshandsker!*



Paket

Bodenplattenpaket · Package for floor panels · Colis des plaques de fond · Bodemplaatpakket · Paquete de las placas de suelo · Pacchetto pavimentazione · Gulvpladepakke

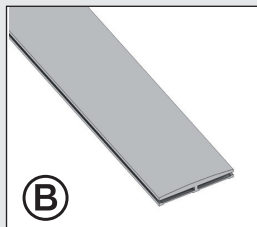
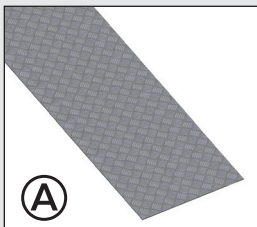



HighLine® / Panorama®

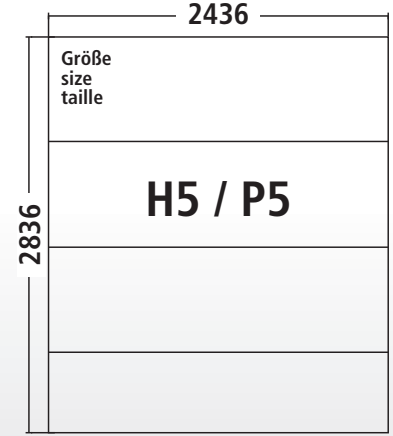
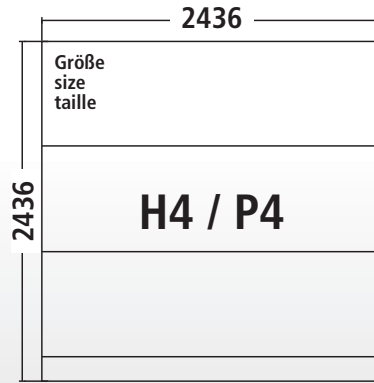
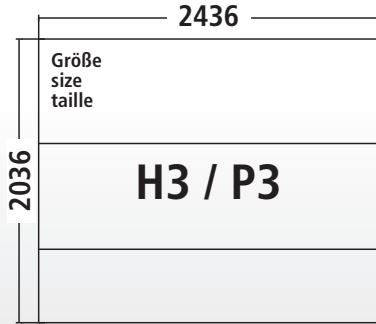
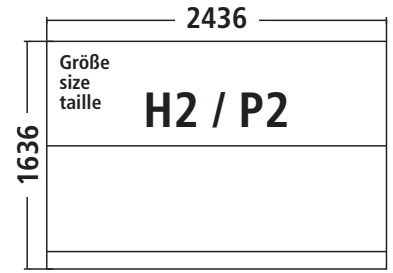
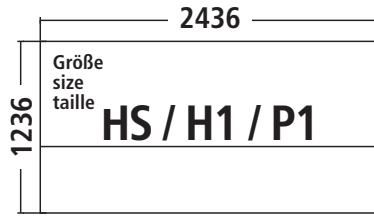

AvantGarde®

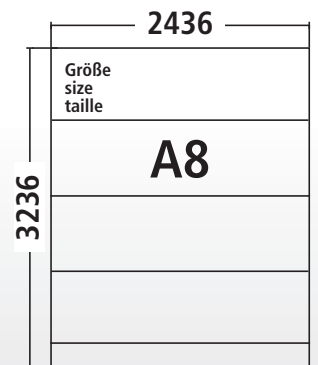
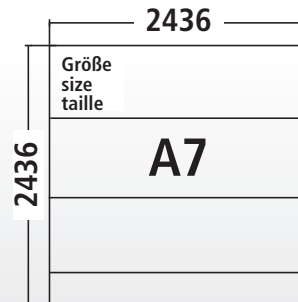
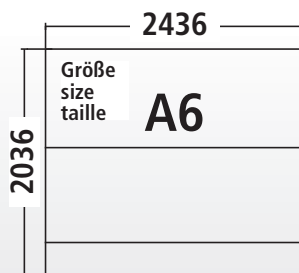
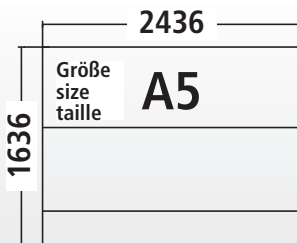
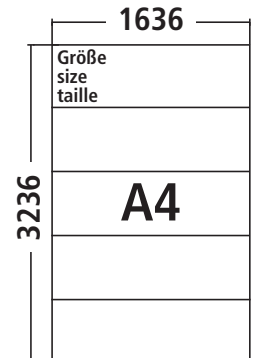
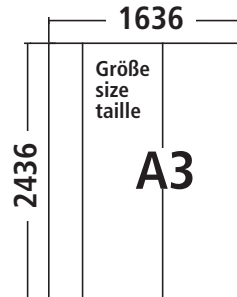
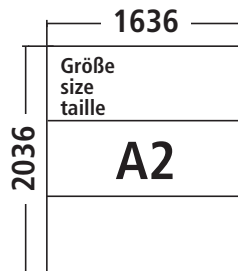
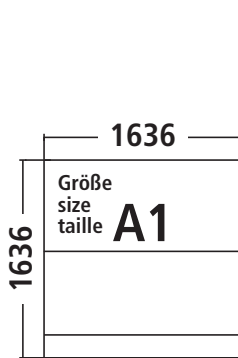



NEO

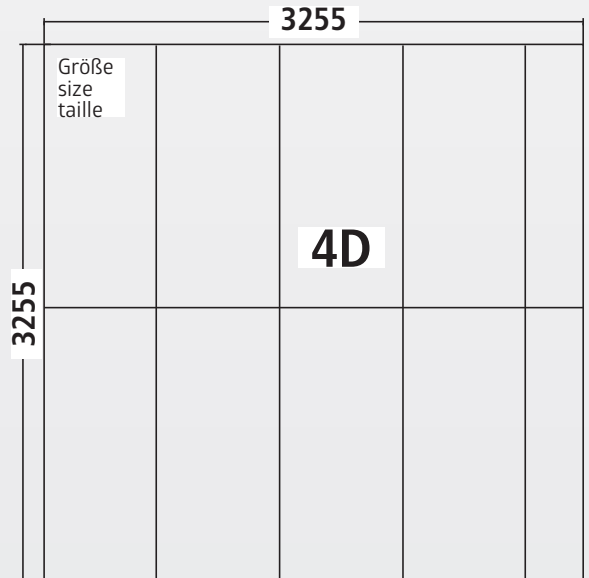
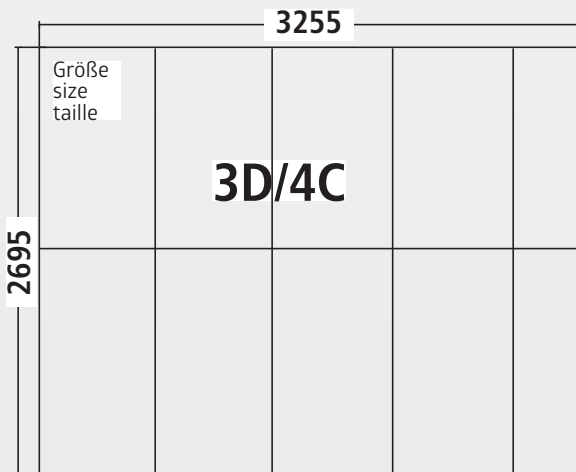
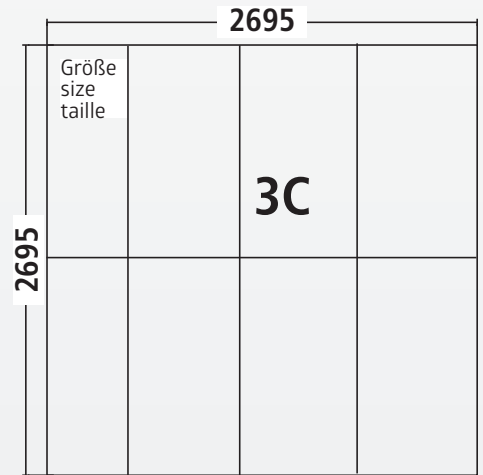
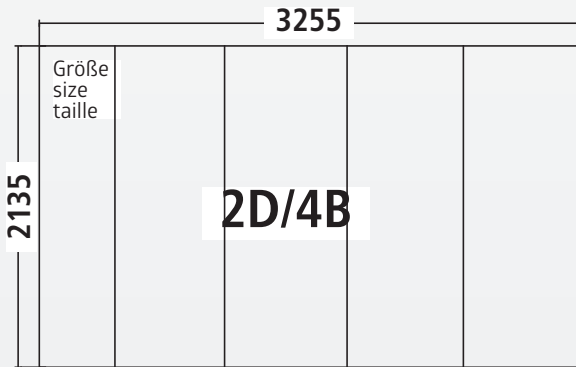
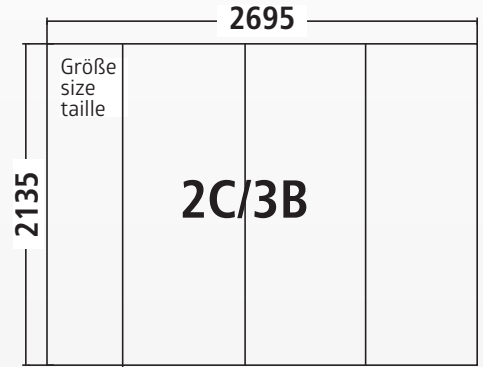
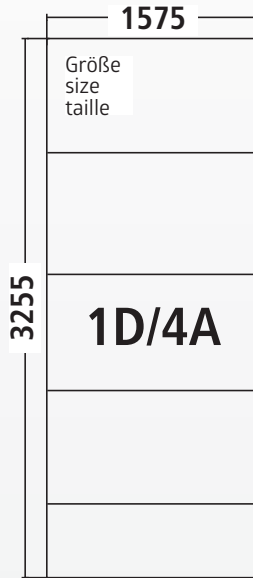
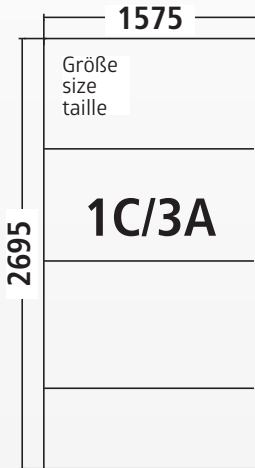
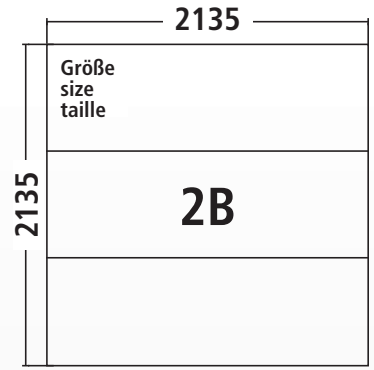
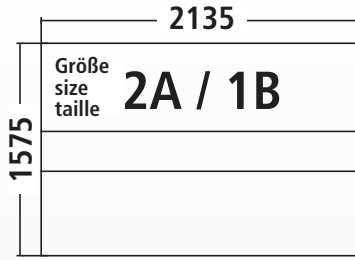
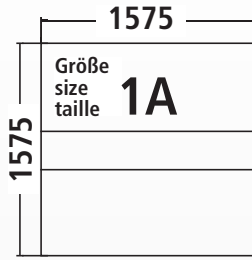



Europa

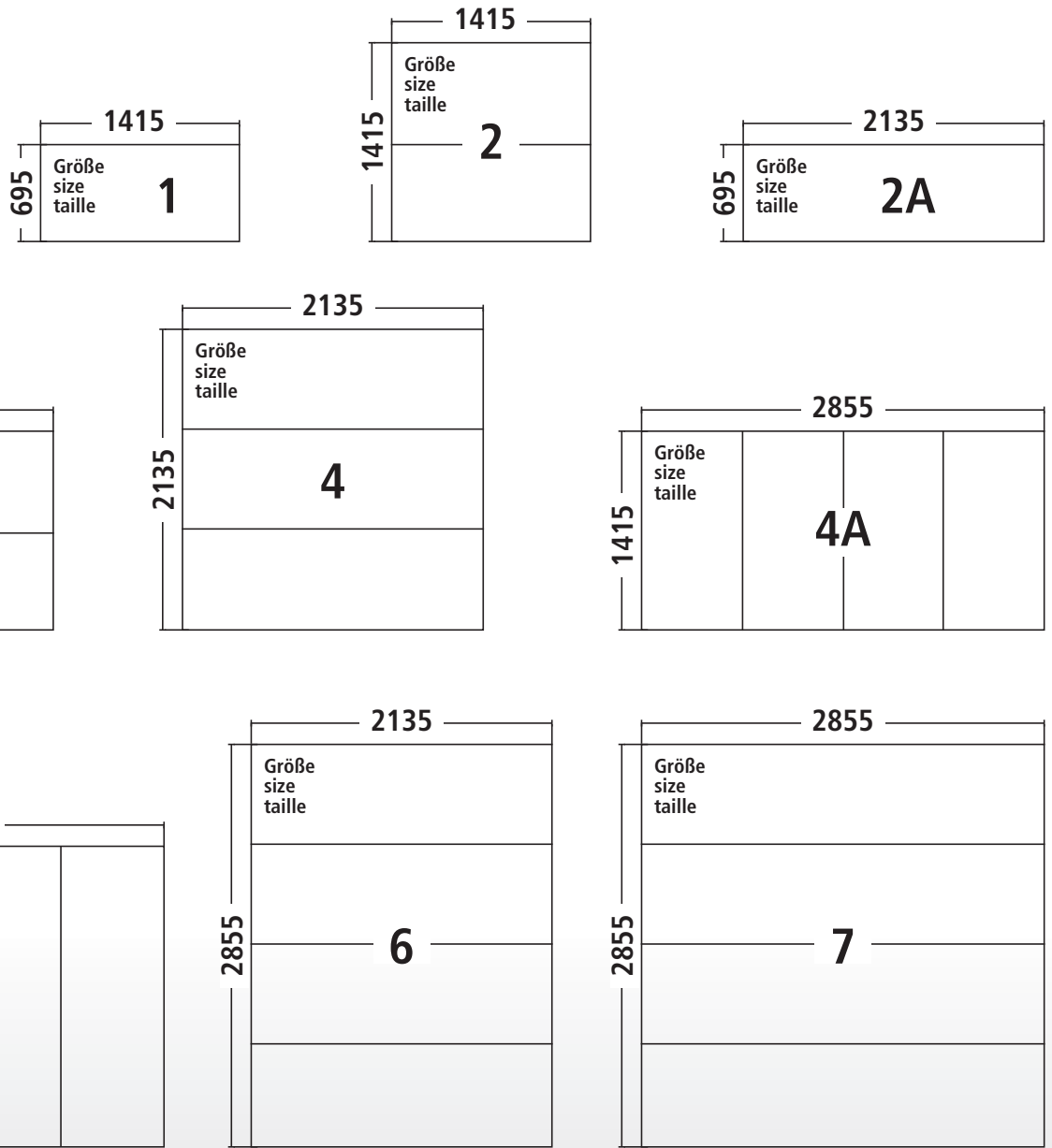

Geräteschrank

Equipment locker
Armoire à outils



MiniGarage

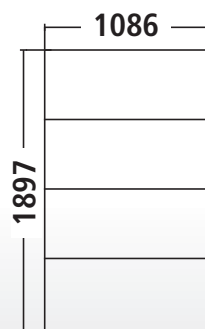

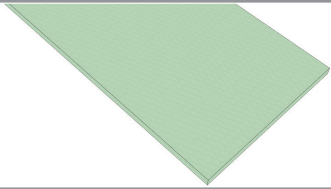
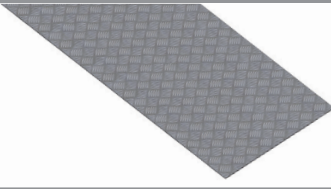
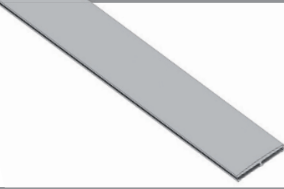
		
<p>Europa</p> <p>1: 2X (1250 x 600mm) 2: 3X (1250 x 600mm) 2A: 2X (1250 x 600mm) 3: 5X (1250 x 600mm) 4: 7X (1250 x 600mm) 4A: 6X (1250 x 600mm) 5: 9X (1250 x 600mm) 6: 9X (1250 x 600mm) 7: 13X (1250 x 600mm)</p>	<p>Europa</p> <p>1: 1X (1415 x 695mm) 2: 1X (1415 x 695mm) 1X (1415 x 716mm) 2A: 1X (2135 x 695mm) 3: 1X (2135 x 695mm) 1X (2135 x 716mm) 4: 1X (2135 x 695mm) 2X (2135 x 716mm) 4A: 1X (1415 x 695mm) 3X (1415 x 716mm) 5: 1X (2135 x 695mm) 3X (2135 x 716mm) 6: 1X (2135 x 695mm) 3X (2135 x 716mm) 7: 1X (2855 x 695mm) 3X (2855 x 716mm)</p>	<p>Europa</p> <p>1: 0x 2: 1X (1415 mm) 2A: 0x 3: 1X (2135 mm) 4: 2X (2135 mm) 4A: 3X (1415 mm) 5: 3X (2135 mm) 6: 3X (2135 mm) 7: 3X (2855 mm)</p>
<p>HighLine®/Panorama</p> <p>HS/H1/P1: 5X (1250 x 600mm) H2/P2: 6X (1250 x 600mm) H3/P3: 7X (1250 x 600mm) H4/P4: 9X (1250 x 600mm) H5/P5: 10X (1250x 600mm)</p>	<p>HighLine®/Panorama</p> <p>HS/H1/P1: 1X (2436 x 485mm) 1X (2436 x 746mm) H2/P2: 1X (2436 x 135mm) 2X (2436 x 746mm) H3/P3: 1X (2436 x 535mm) 2X (2436 x 746mm) H4/P4: 3X (2436 x 746mm) 1X (2436 x 185mm) H5/P5: 1X (2436 x 585mm) 3X (2436 x 746mm)</p>	<p>HighLine®/Panorama</p> <p>HS/H1/P1: 1X (2436 mm) H2/P2: 2X (2436 mm) H3/P3: 2X (2436 mm) H4/P4: 3X (2436 mm) H5/P5: 3X (2436 mm)</p>
<p>AvantGarde®</p> <p>A1: 4X (1250 x 600mm) A2: 5X (1250 x 600mm) A3: 6X (1250 x 600mm) A4: 8X (1250 x 600mm) A5: 6X (1250 x 600mm) A6: 7X (1250 x 600mm) A7: 9X (1250 x 600mm) A8: 11X (1250 x 600mm)</p>	<p>AvantGarde®</p> <p>A1: 1X (1636 x 135mm) 2X (1636 x 746mm) A2: 3X (1636 x 674mm) A3: 1X (2436 x 135mm) 2X (2436 x 746mm) A4: 5X (1636 x 642mm) A5: 1X (2436 x 135mm) 2X (2436 x 746mm) A6: 1X (2436 x 535mm) 2X (2436 x 746mm) A7: 3X (2436 x 746mm) 1X (2436 x 185mm) A8: 4X (2436 x 746mm) 1X (2436 x 235mm)</p>	<p>AvantGarde®</p> <p>A1: 2X (1636 mm) A2: 2X (1636 mm) A3: 2X (1636 mm) A4: 4X (1636 mm) A5: 2X (2436 mm) A6: 2X (2436 mm) A7: 3X (2436 mm) A8: 4X (2436 mm)</p>
<p>NEO</p> <p>1A: 4X (1250 x 600mm) 2A/1B: 6X (1250 x 600mm) 2B: 7X (1250 x 600mm) 1C/3A: 8X (1250 x 600mm) 1D/4A: 9X (1250 x 600mm) 2C/3B: 9X (1250 x 600mm) 2D/4B: 11X (1250 x 600mm) 3C: 11X (1250 x 600mm) 3D/4C: 12X (1250 x 600mm) 4D: 14X (1250 x 600mm)</p>	<p>NEO</p> <p>1A: 2X (1575 x 716mm) 1X (1575 x 135mm) 2A/1B: 2X (2135 x 716mm) 1X (2135 x 135mm) 2B: 2X (2135 x 716mm) 1X (2135 x 695mm) 1C/3A: 3X (1575 x 716mm) 1X (1575 x 535mm) 1D/4A: 4X (1575 x 716mm) 1X (1575 x 375mm) 2C/3B: 3X (2135 x 695mm) 1X (2135 x 598mm) 2D/4B: 4X (2135 x 695mm) 1X (2135 x 459mm) 3C: 6X (1345 x 716mm) 2X (1345 x 535mm) 3D/4C: 8X (1345 x 716mm) 2X (1345 x 375mm) 4D: 8X (1625 x 716mm) 2X (1625 x 375mm)</p>	<p>NEO</p> <p>1A: 2X (1575 mm) 2A/1B: 2X (2135mm) 2B: 2X (2135mm) 1C/3A: 3X (1575mm) 1D/4A: 4X (1575mm) 2C/3B: 3X (2135mm) 2D/4B: 4X (2135mm) 3C: 6X (1317mm) 2X (1346mm) 3D/4C: 8X (1317mm) 2X (1626mm) 4D: 8X (1597mm) 2X (1626mm)</p>
<p>Geräteschrank <i>Equipment Locker</i> <i>Armoire à outils</i></p> <p>90: 1X (1250 x 600mm) 150: 2X (1250 x 600mm) 230: 2X (1250 x 600mm)</p>	<p>Geräteschrank <i>Equipment Locker</i> <i>Armoire à outils</i></p> <p>90: 1X (795 x 695mm) 150: 1X (1415 x 695mm) 230: 1X (2135 x 695mm)</p>	<p>Geräteschrank <i>Equipment Locker</i> <i>Armoire à outils</i></p> <p>90: 0x 150: 0x 230: 0x</p>
<p>MiniGarage</p> <p>MG: 3x</p>	<p>MiniGarage</p> <p>MG: 4x (1086 x 470,5mm)</p>	<p>MiniGarage</p> <p>MG: 3x (1086 mm)</p>

Unterbau für Bodenplatten mit XPS-Platten (2 cm od. 3 cm) (nicht im Lieferumfang)

- ⒸGB *Substructure of the floor panels with XPS-boards (2 cm | 3 cm) (not included in the scope of delivery)*
- ⒸFR *Les plaques XPS (2 cm | 3 cm) pour les plaques de fond ne sont pas fournies.*
- ⒸNL *De XPS- platen die onder de bodemplaat komen, zijn bij de levering niet inbegrepen.*
- ⒸES *Las placas XPS (2 cm | 3 cm) sobre las que se coloca la placa de suelo no forman parte del suministro.*
- ⒸIT *Placca XPS (2 cm | 3 cm) per basamento di una pavimentazione in alluminio non forniti in dotazione.*
- ⒸDK *Underlæg for bundplader med XPS-plader (2 cm eller 3 cm) (følger ikke med)*

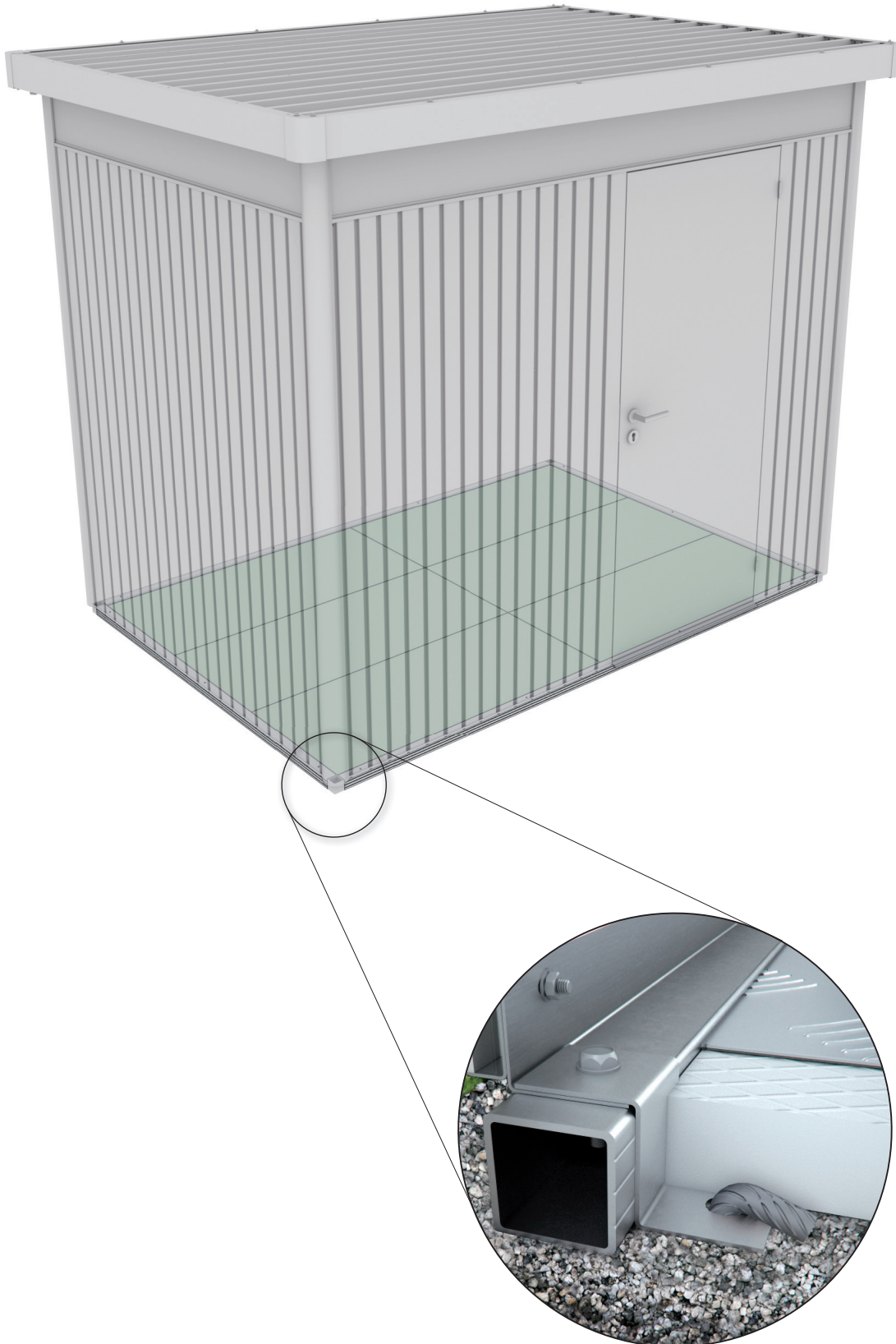

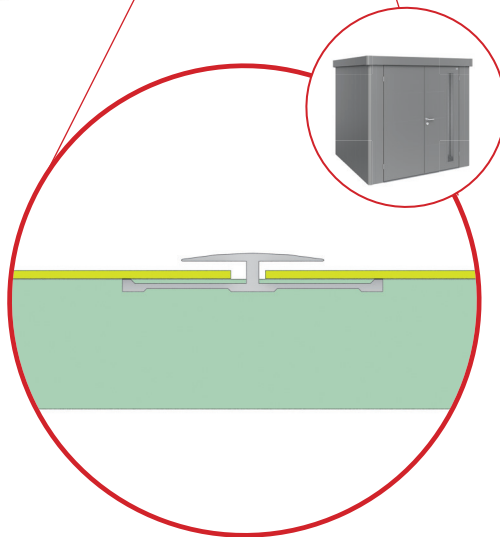
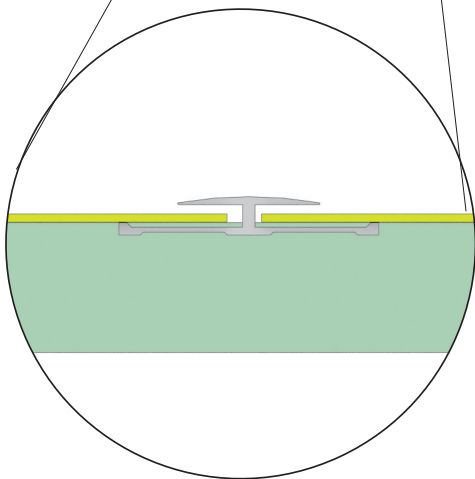
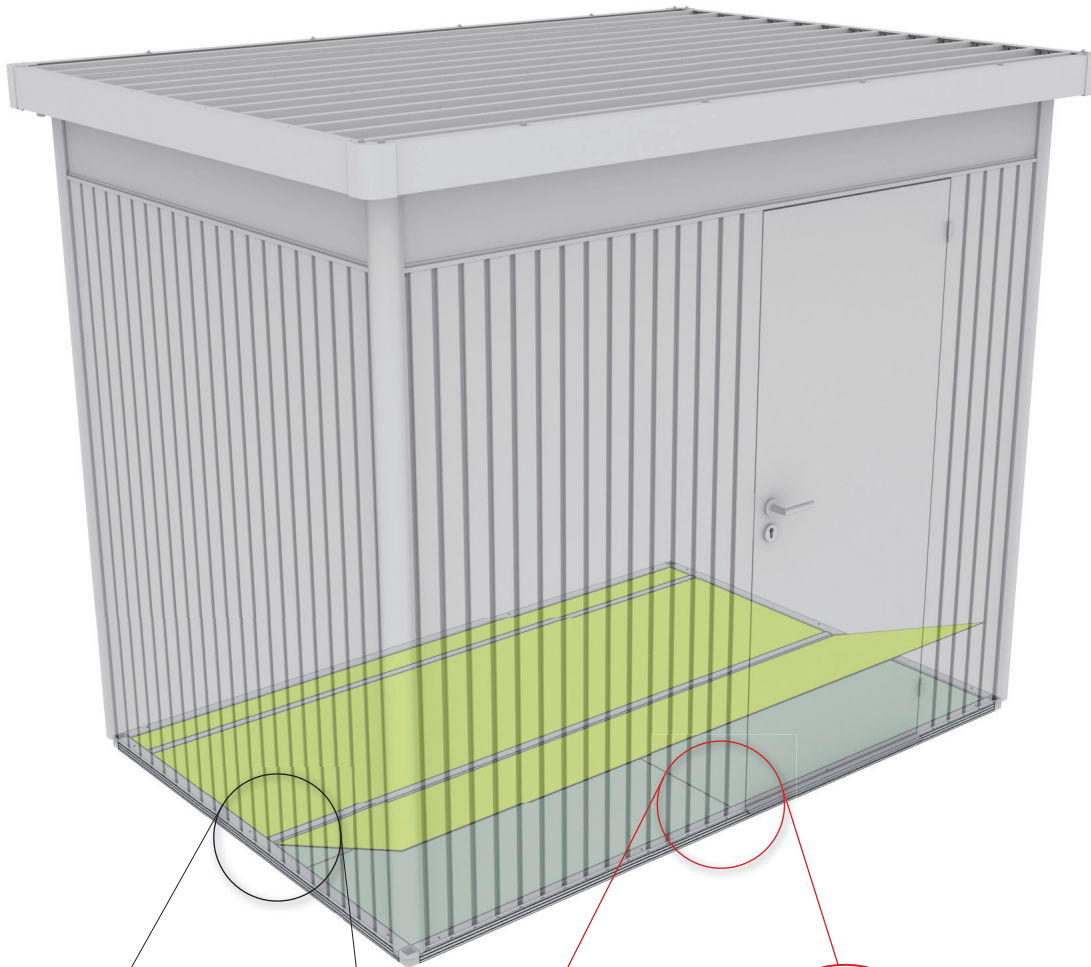

NUR FÜR GRÖSSE 3C, 4C, 3D, 4D

- Ⓒ Only for size 3C, 4C, 3D, 4D
- Ⓕ Uniquement pour taille 3C, 4C, 3D, 4D
- Ⓖ Alleen voor maat 3C, 4C, 3D, 4D
- Ⓔ Sólo para el tamaño 3C, 4C, 3D, 4D
- Ⓗ Solo per misura 3C, 4C, 3D, 4D
- Ⓓ Kun for størrelse 3C, 4C, 3D, 4D
- Ⓔ Endast för storlek 3C, 4C, 3D, 4D
- Ⓖ Bare til str 3C, 4C, 3D, 4D
- Ⓖ Czynność tylko dla wielkości 3C, 4C, 3D, 4D
- Ⓒ Len pre veľ. 3C, 4C, 3D, 4D
- Ⓒ Samo za velikosti 3C, 4C, 3D, 4D
- Ⓒ Pouze pro vel. 3C, 4C, 3D, 4D
- Ⓒ Csak 3C, 4C, 3D, 4D es mérethez
- Ⓒ Samo za veličine 3C, 4C, 3D, 4D

Kontrollnummer:
Control-number / Contrôle-Qualité / Controlnummer:

Bei Reklamationen bitte anführen:
Kontrollnummer und Artikelnummer des reklamierten Teils.

GB: In case of complaint please indicate the control-number and the number of the item, which is subject of complaint.

F: Pour toutes réclamations: prière de joindre le numéro de contrôle et le numéro d'article de la pièce litigieuse.

NL: Bij reclamaties svp doorgeven: controlnummer en artikelnummer van het desbetreffende onderdeel.

Y4048001_1221



Biohort GmbH
Pürnstein 43, 4120 Neufelden, Österreich
Tel.: +43-7282-7788-0, Fax-DW: 190
E-Mail: office@biohort.at, www.biohort.com