

AUFBAUANLEITUNG

Mähkante für HochBeet

- Ⓜ Assembly Manual Raised Vegetable Bed "Skirting"
- Ⓜ Notice de montage potager surélevé „bordure pour tondeuse“
- Ⓜ Opbouwbeschrijving Maairand
- Ⓜ Instrucciones de construcción Cama elevada „Borde de corte“
- Ⓜ Istruzioni di montaggio HighBed „Mowing Edge“
- Ⓜ Monteringsvejledning for Høyled "Klippekant"
- Ⓜ Monteringsanvisning for Upphöjd grönsaksbädd "Socklar"
- Ⓜ Monteringsanvisning for Høyled *Pynte kant"
- Ⓜ Instrukcja montażu Podwyższonej grządki warzywnej „Listwa"
- Ⓜ Návod na montáž vysoký záhon „Soklová lišta"
- Ⓜ Navodila za montažo Dvignjena postelja „rob za košnjo"
- Ⓜ Návod na montáž zvýšený truhlík „Soklová lišta"
- Ⓜ Felépítési útmutató Magyaságyás „Fűnyíró szegély"
- Ⓜ Upute za montažu podignutog kreveta „rezní rub"

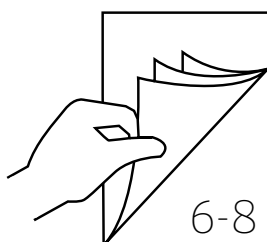
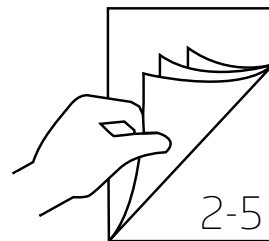

TEILEÜBERSICHT



Parts list · Liste des pièces · Stuklijst · Lista de piezas · Lista de parti · Deloversigt · Delöversikt · Del liste ·
Przegląd elementów · Zoznam dielov · Seznam delov · Seznam dílů · Tétélek áttekintése · Popis dijelova

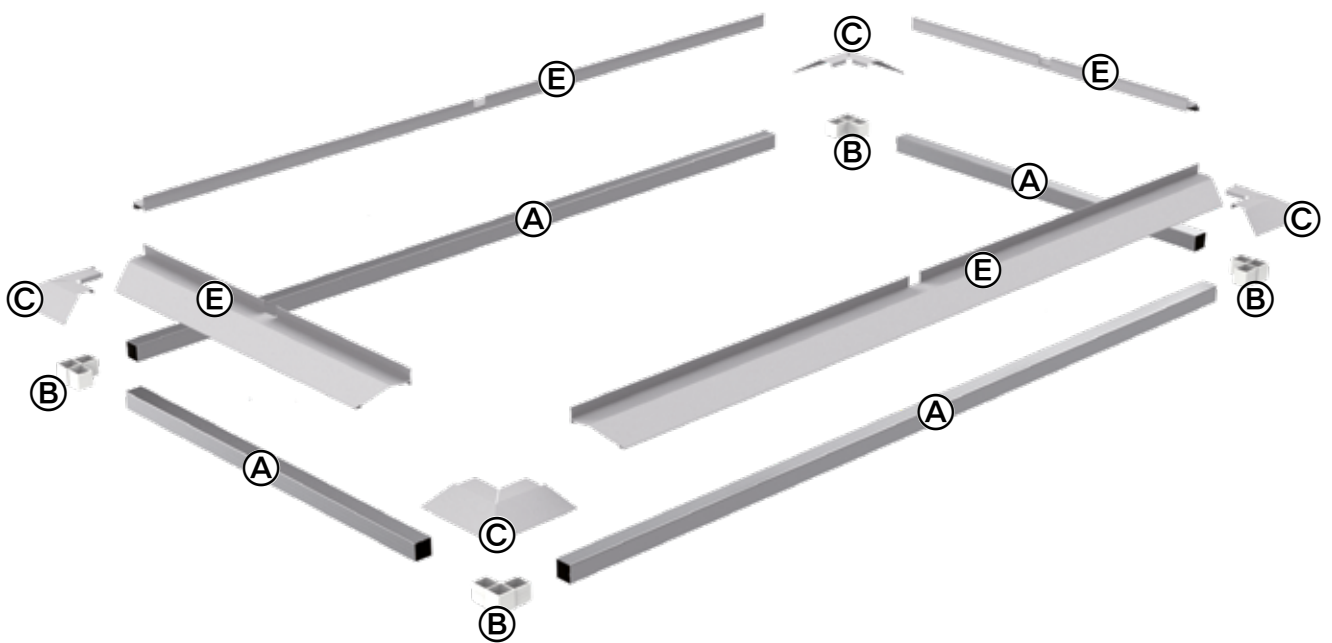
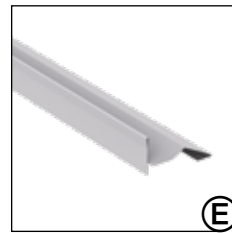
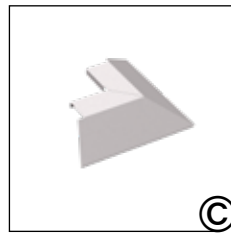
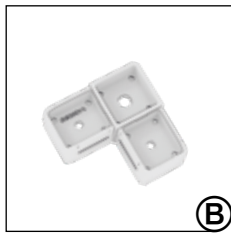
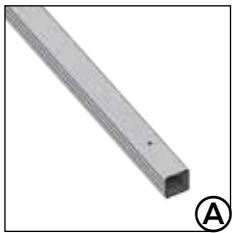

1.

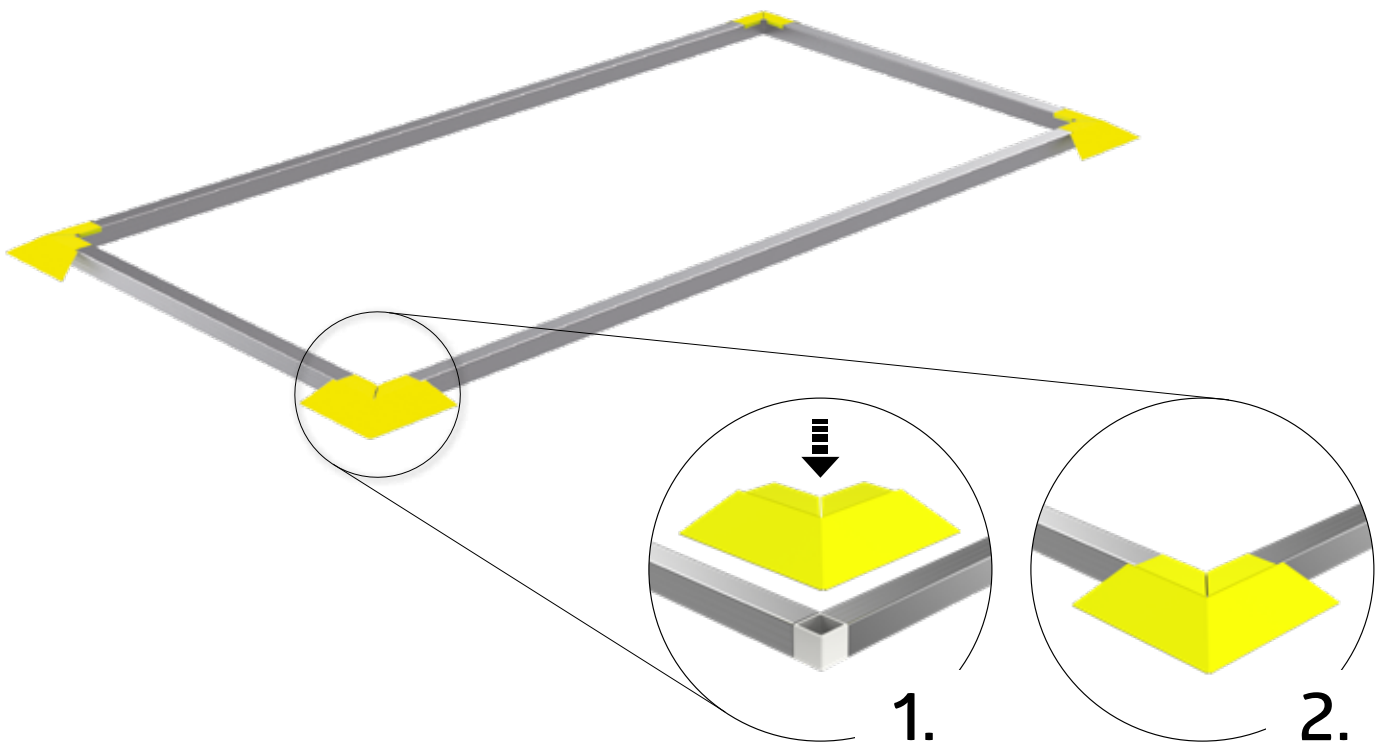
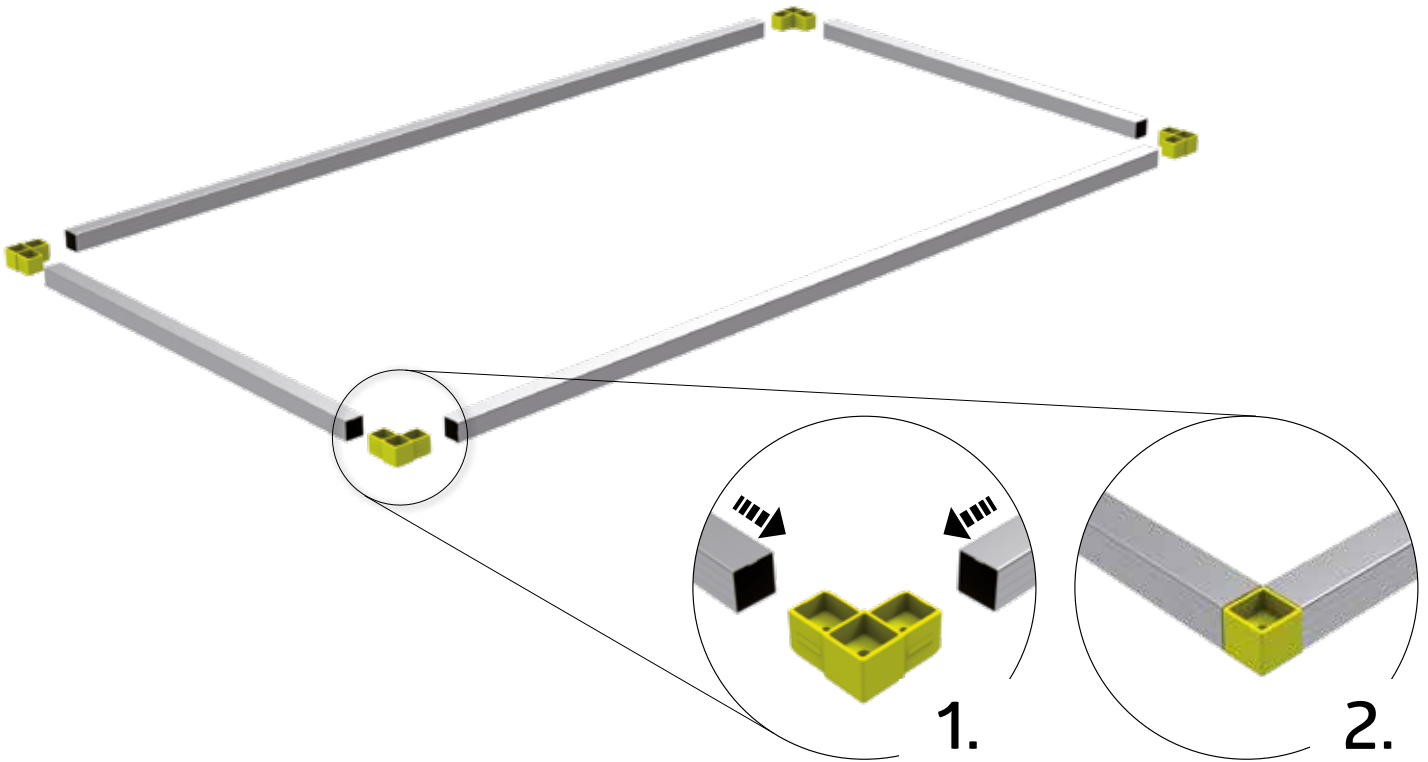
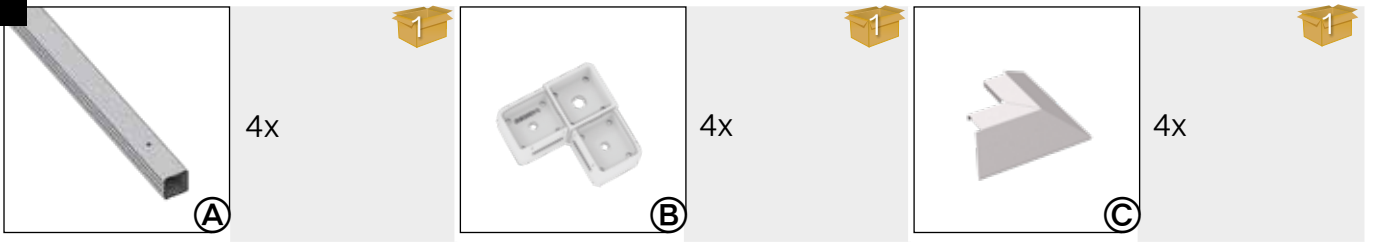

2.

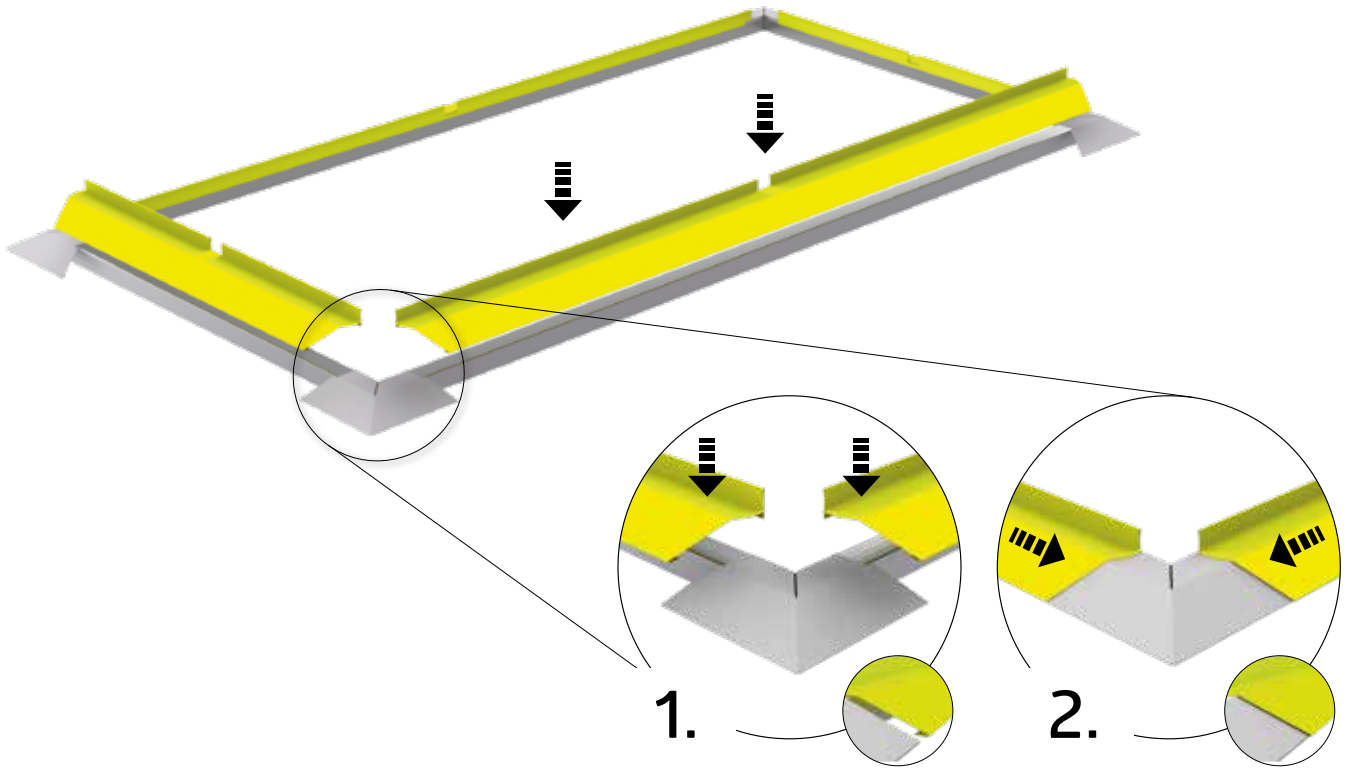
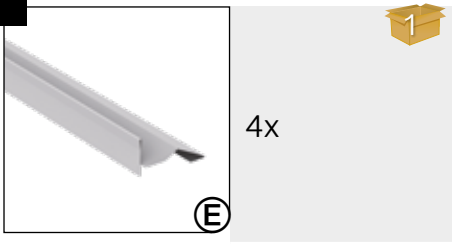

3.

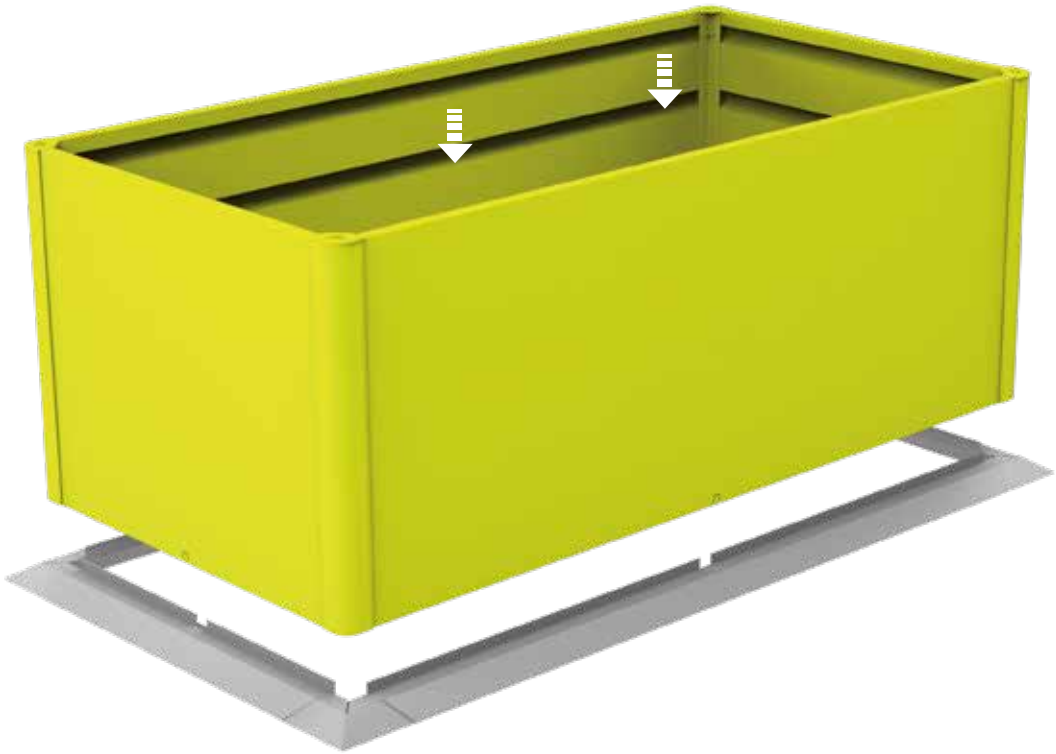

TEILEÜBERSICHT



Parts list · Liste des pièces · Stuklijst · Lista de piezas · Lista de parti · Deloversigt · Delöversikt · Del liste ·
Przegląd elementów · Zoznam dielov · Seznam delov · Seznam dílů · Tétélek áttekintése · Popis dijelova

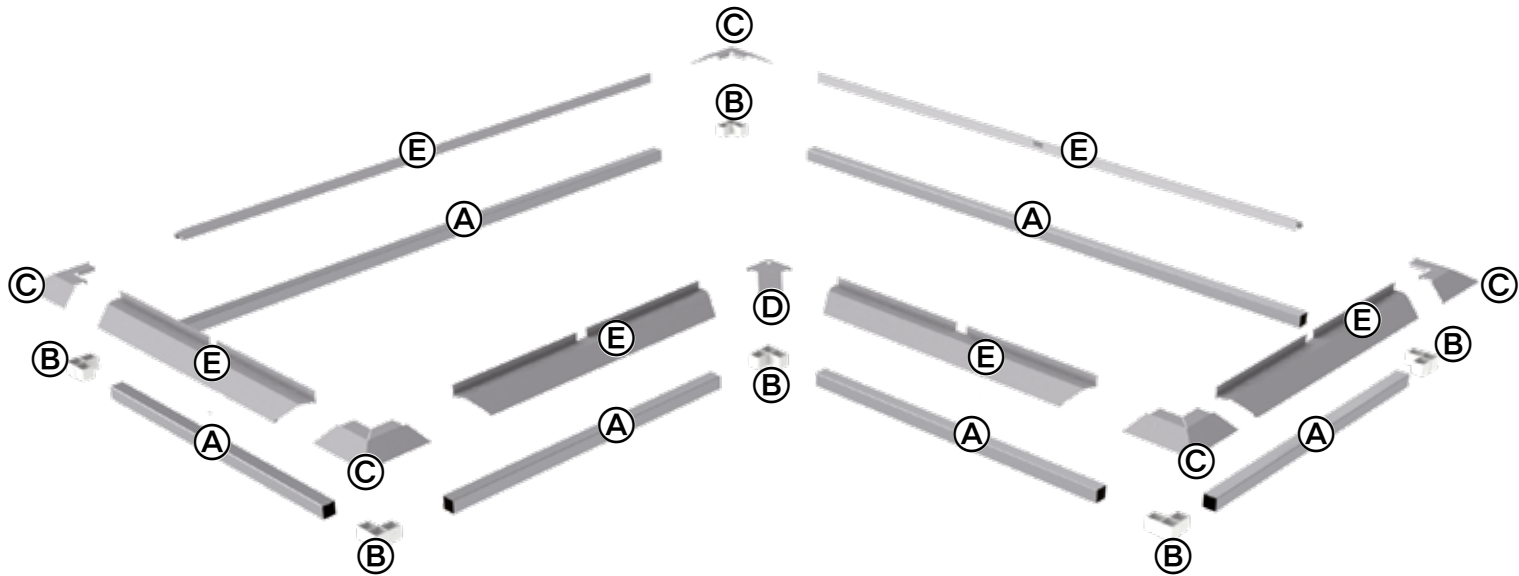
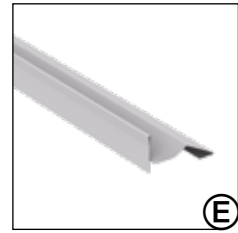
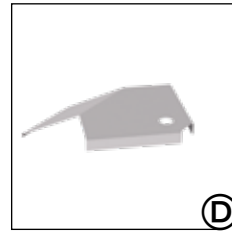
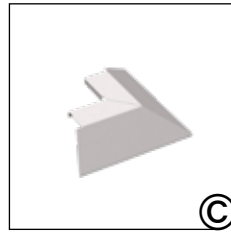
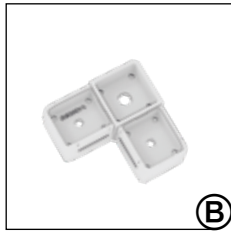
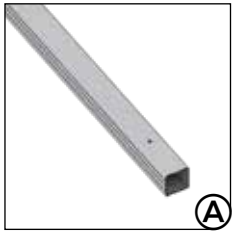

1.

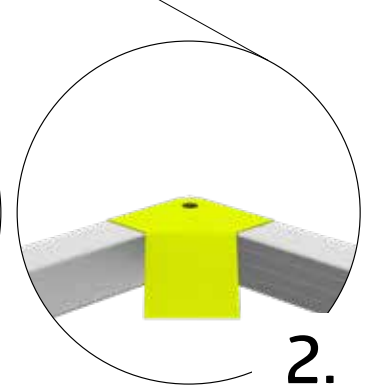
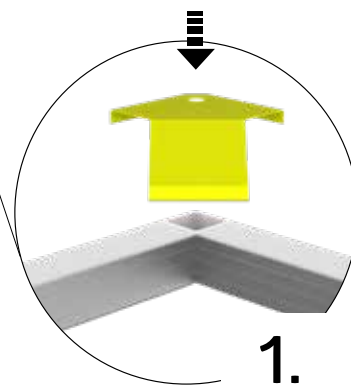
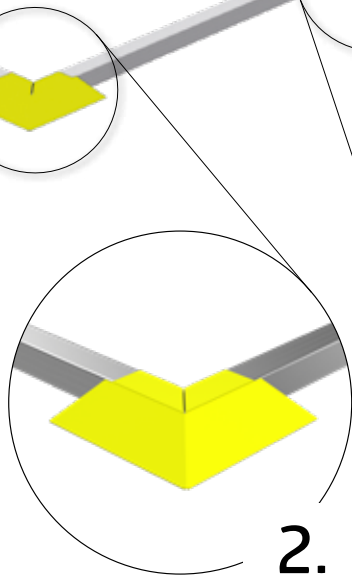
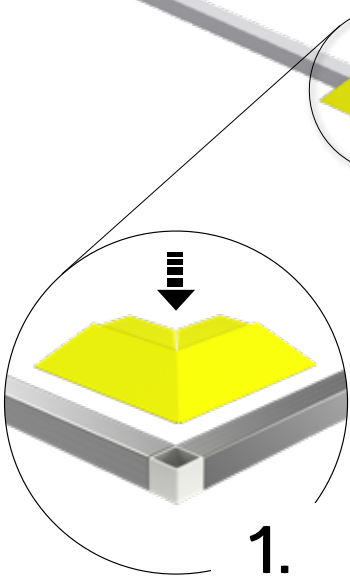
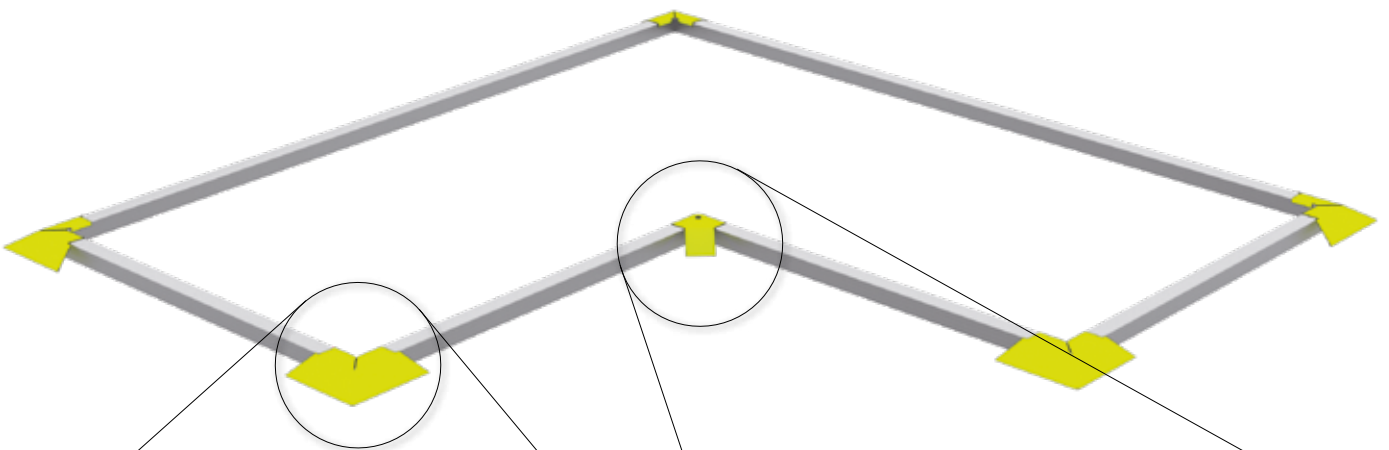
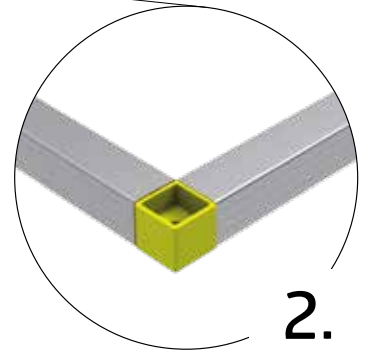
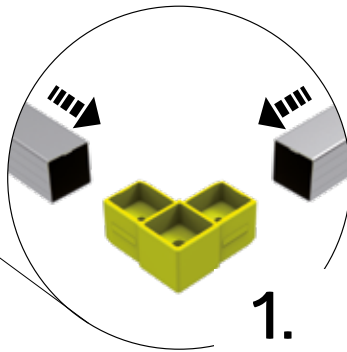
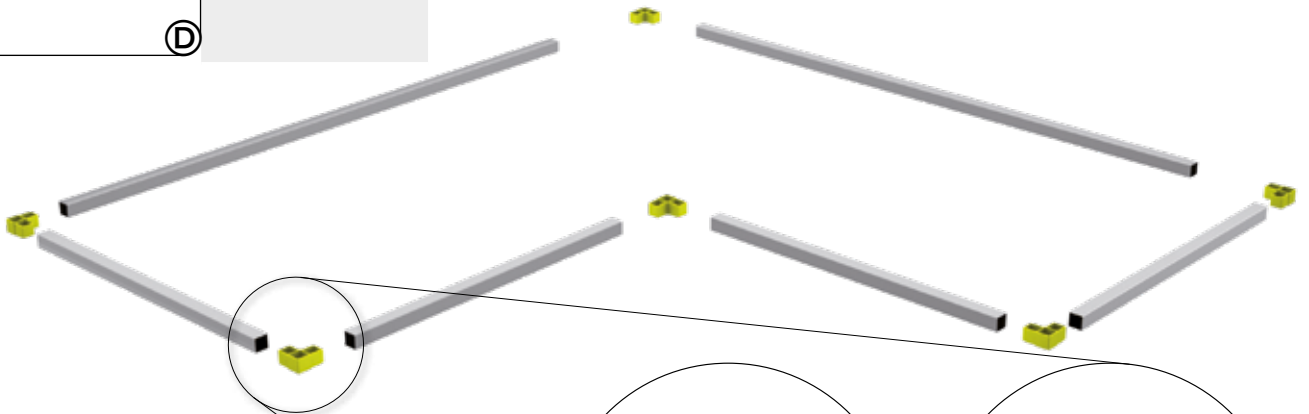
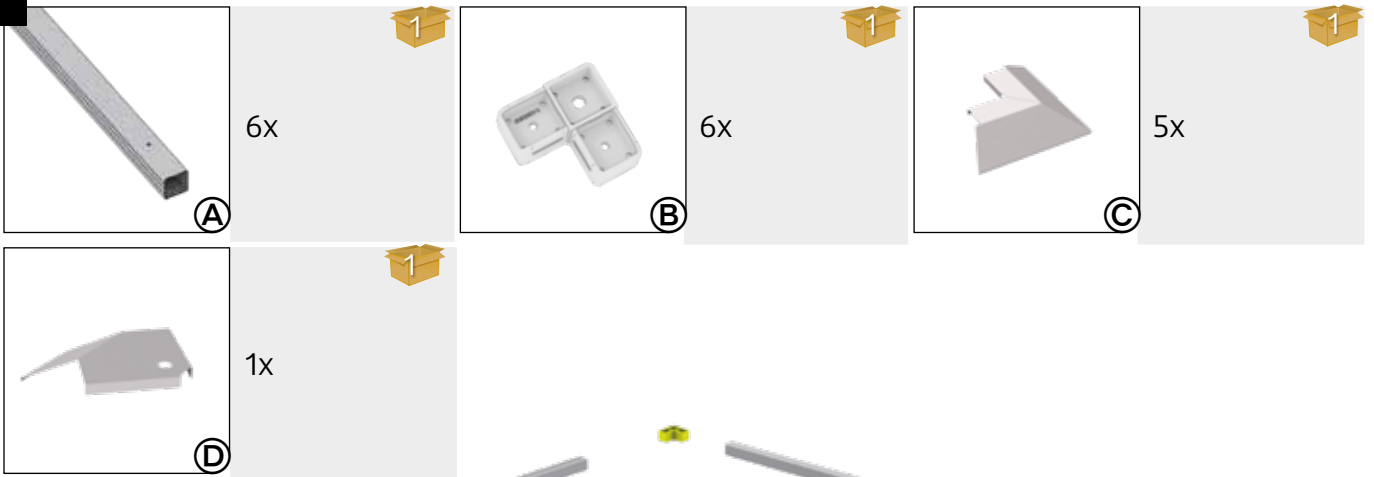

2.

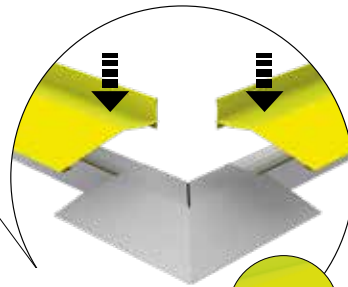
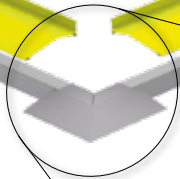
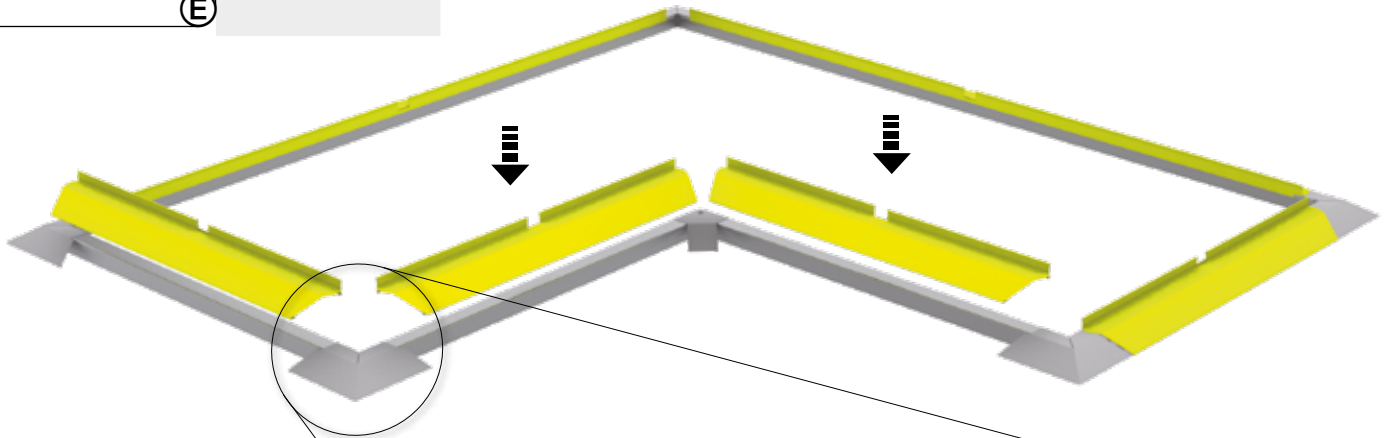
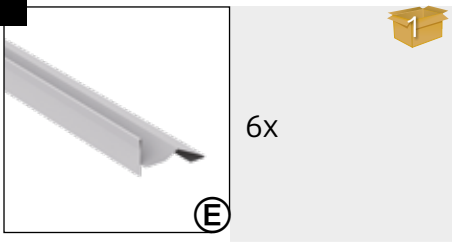

1.

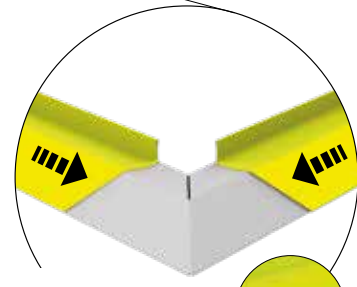
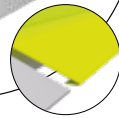

2.

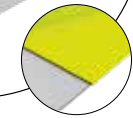

3.



Kontrollnummer:
Control-number / Contrôle-Qualité / Controlnummer:

Bei Reklamationen bitte anführen:
Kontrollnummer und Artikelnummer des reklamierten Teils.

GB: In case of complaint please indicate the control-number and the number of the item, which is subject of complaint.

F: Pour toutes réclamations: prière de joindre le numéro de contrôle et le numéro d'article de la pièce litigieuse.

NL: Bij reclamaties svp doorgeven: controlnummer en artikelnummer van het desbetreffende onderdeel.



Biohort GmbH
Pürnstein 43, 4120 Neufelden, Österreich
Tel.: +43-7282-7788-0
E-Mail: office@biohort.at, www.biohort.com

YF000900_0322