

8095600

Aufbauanleitung

zu Art.Nr. 95600 / 75600

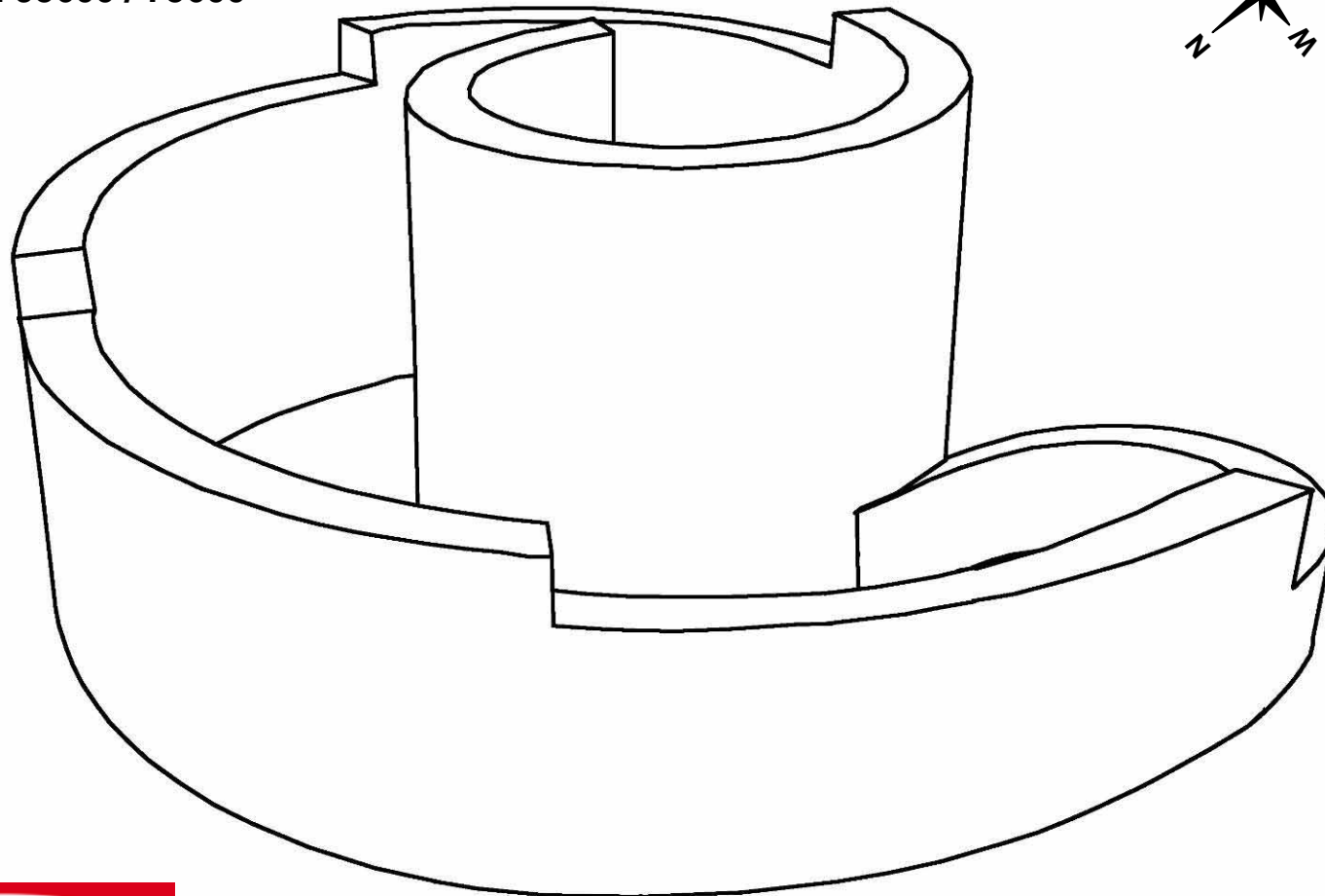
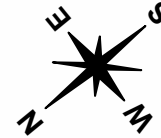

Stand 15.02.2010

Aufbauanleitung / Assembly instructions 95600

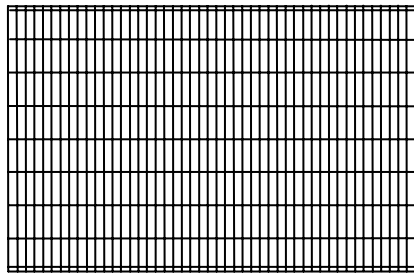
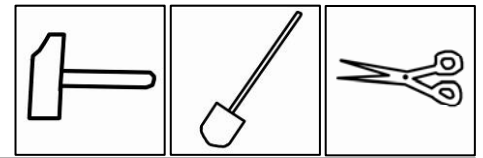

A 3 x 118 x 80 cm

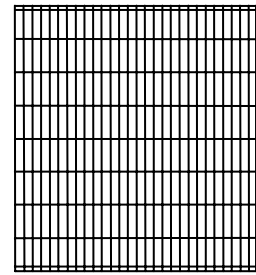

B 1 x 75,5 x 80 cm

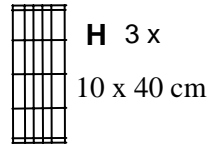

H 3 x
10 x 40 cm



I 4 x
10 x 20 cm

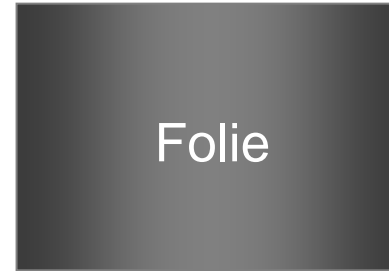

W 1 x 89 x 130 cm

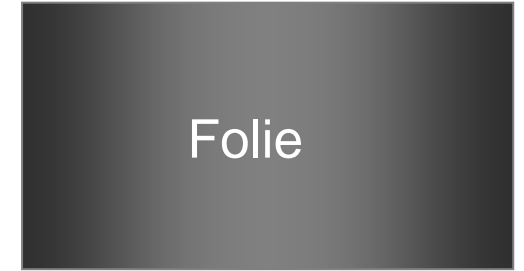

X 1 x 89 x 170 cm

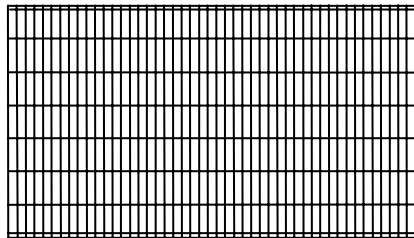

C 2 x 118 x 70 cm

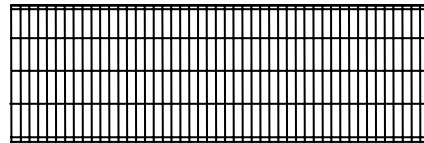

F 2 x 118 x 40 cm



Y 1 x 89 x 380 cm



G 2 x 118 x 20 cm

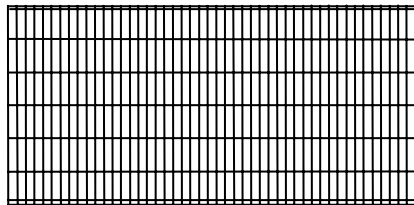

D 2 x 118 x 60 cm



J 10 x Kabelbinder



M 2 x Kabelbinder



Z 1 x 49 x 230 cm



L 90 x
10 cm

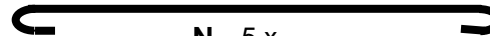

N 5 x
50 cm

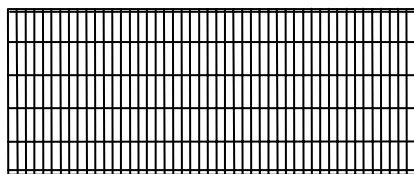

E 2 x 118 x 50 cm

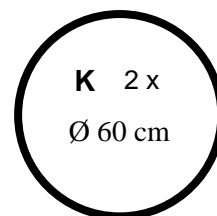

K 2 x
Ø 60 cm

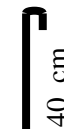

P 4 x
40 cm



Q 2 x
50 cm



R 2 x
60 cm

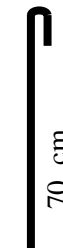

S 2 x
70 cm



T 6 x
80 cm



U 1 x
65 cm



V 1 x
105 cm

1.

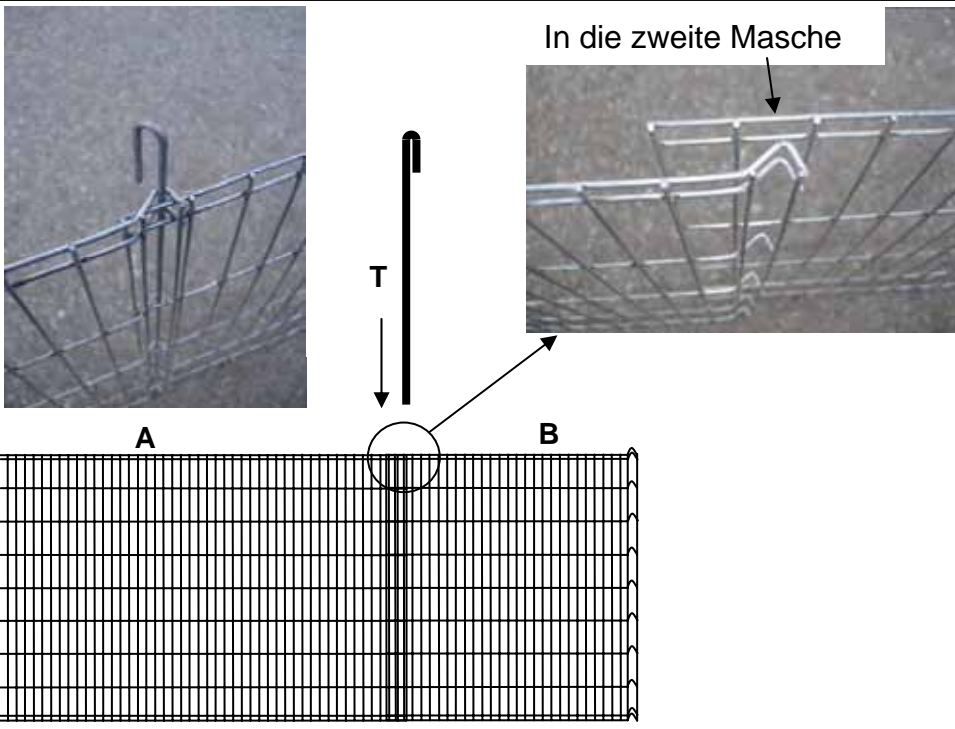

2.

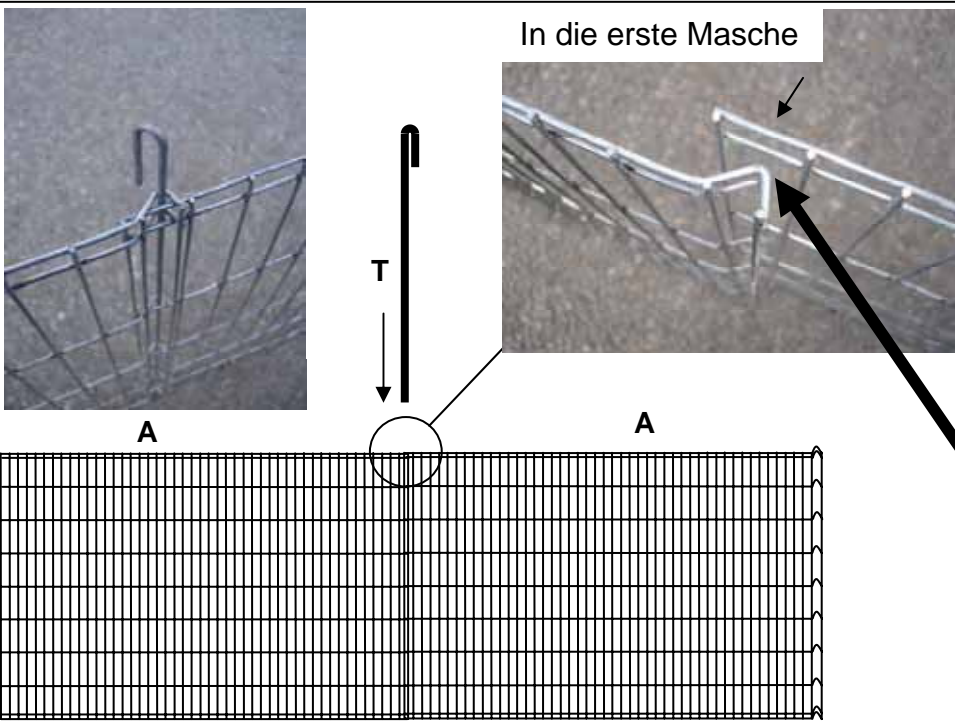

3.

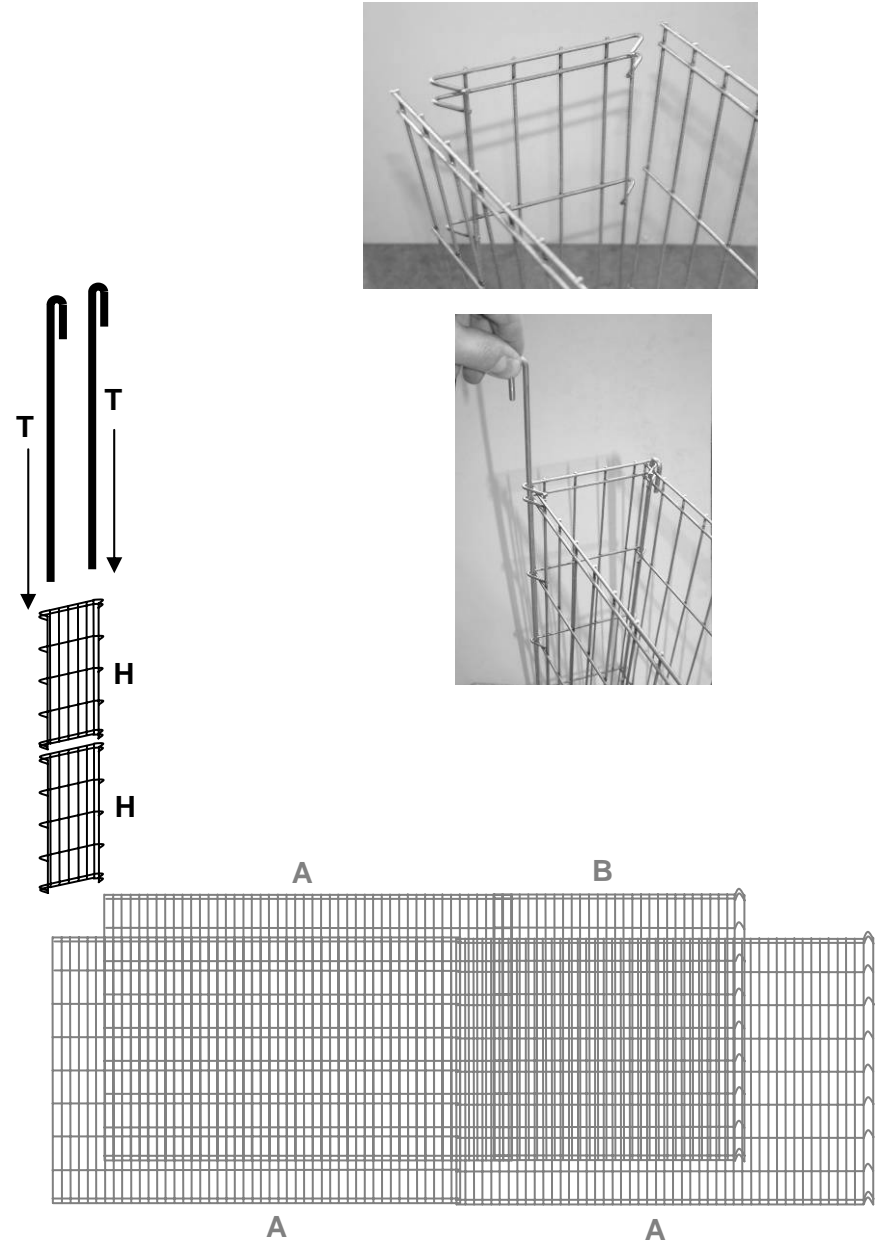

ALLE Gitter außer G (nach außen) ist die Nasenspitze der Sicke zum Spiralenmittelpunkt zu richten

4.

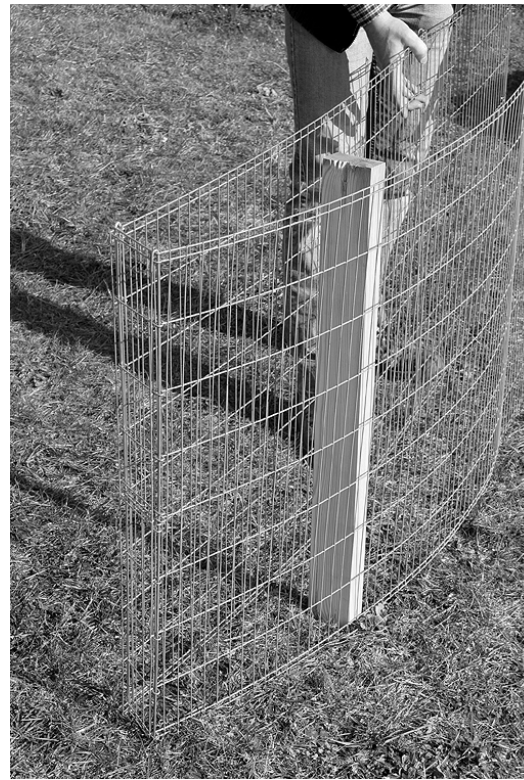
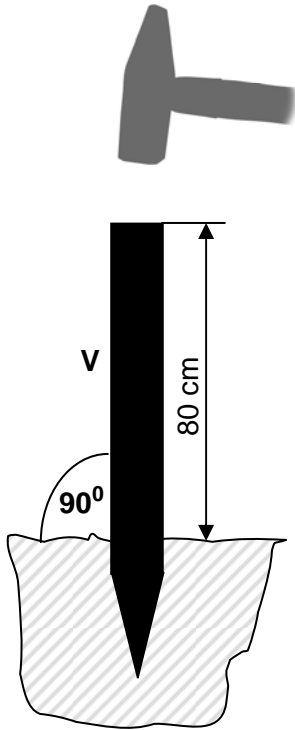
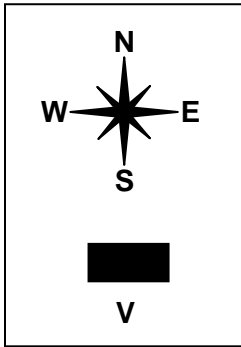

5.

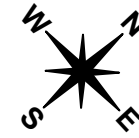

Gitter mit Kabelbinder fest am Pfosten befestigen

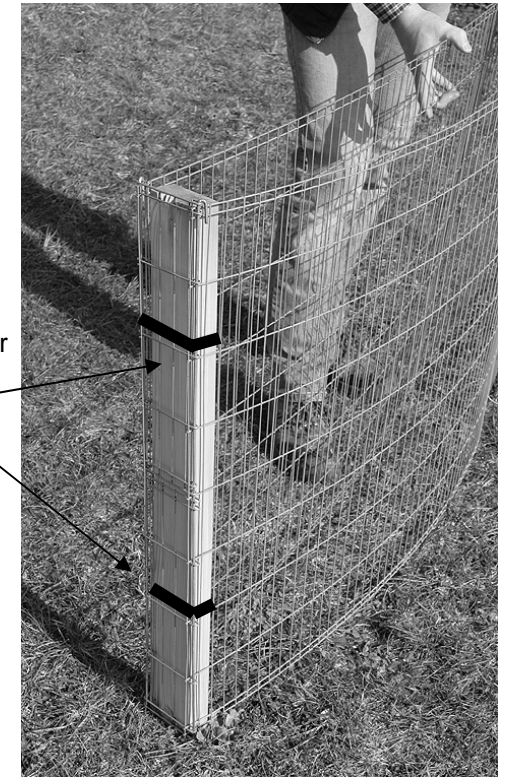
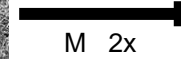

6.

Die Ringe an der inneren, kürzeren Gitterkombination AB mit je 5 Kabelbindern an Gitter A anbringen.

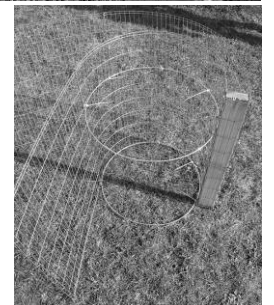
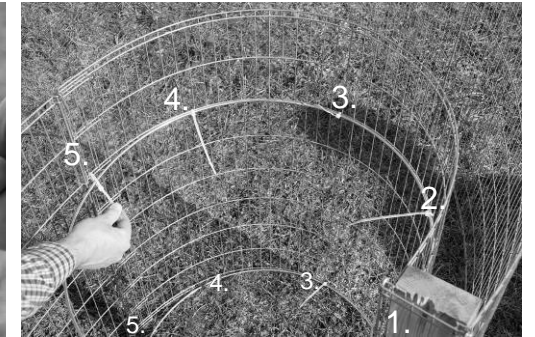
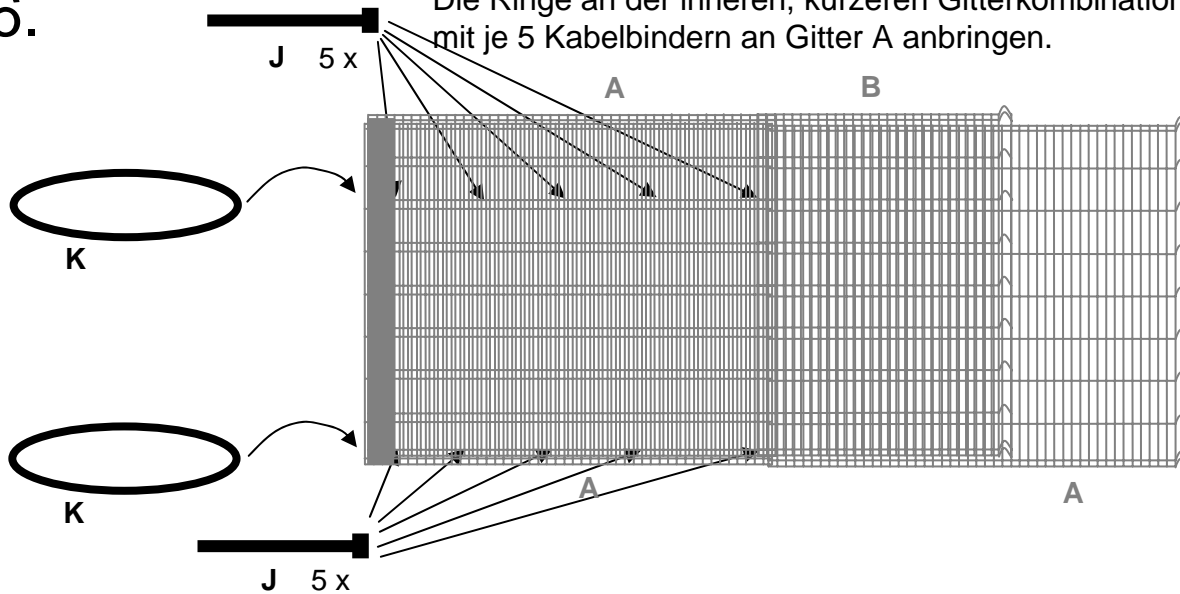

7.

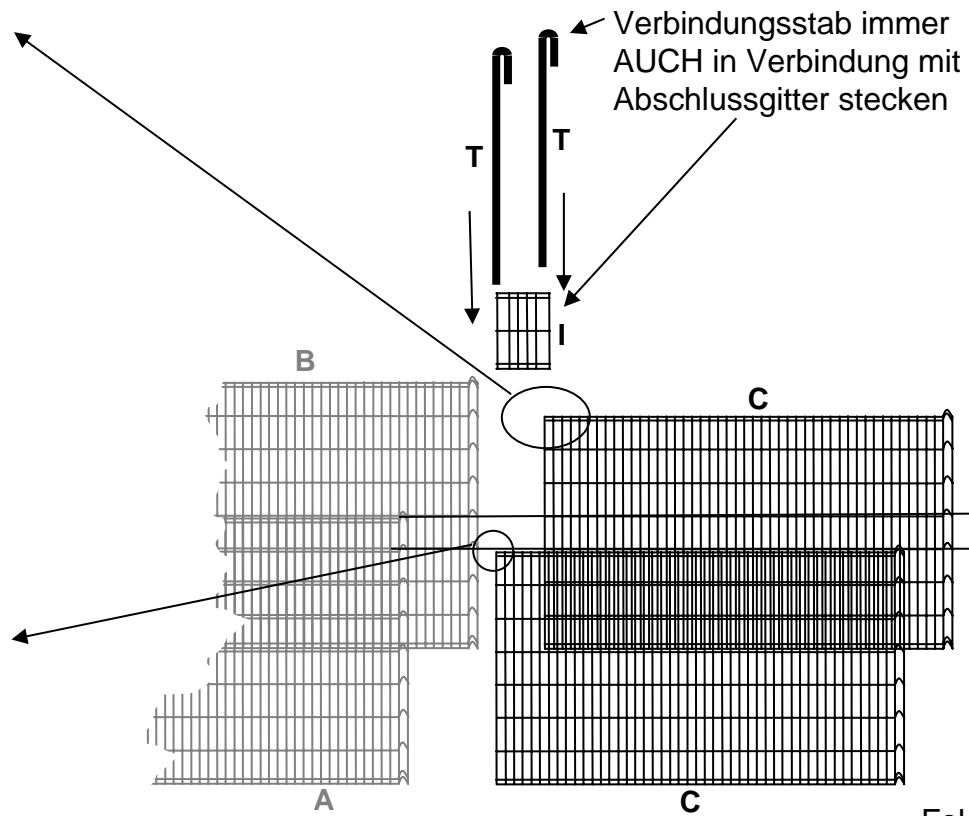
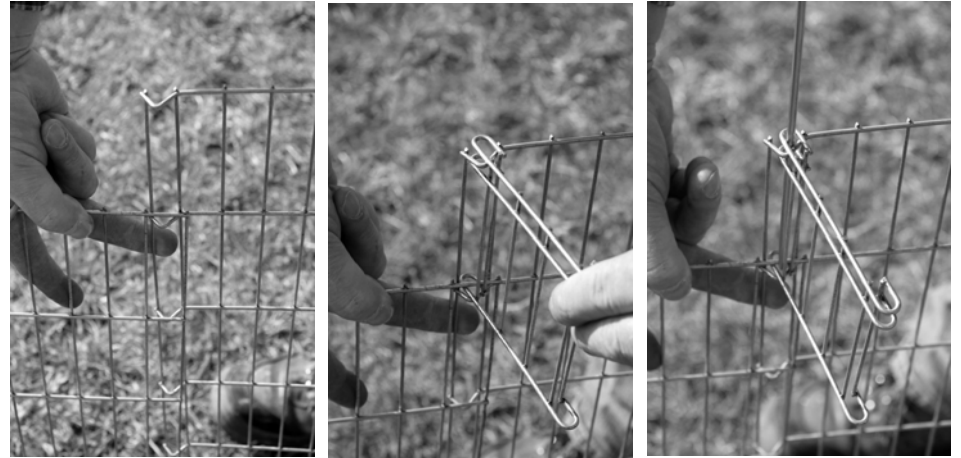
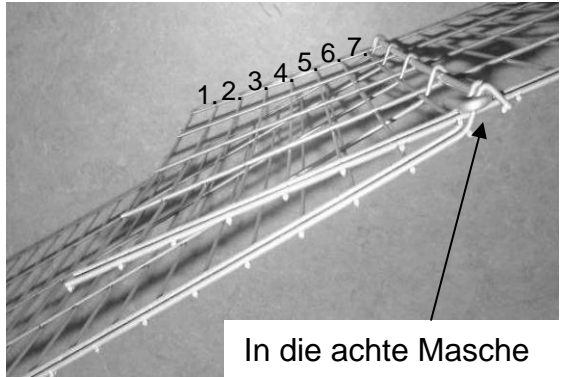

Folgegitter oben 10cm
Absatz zum vorherigen
Gitter (außer F/G 20cm)

8.

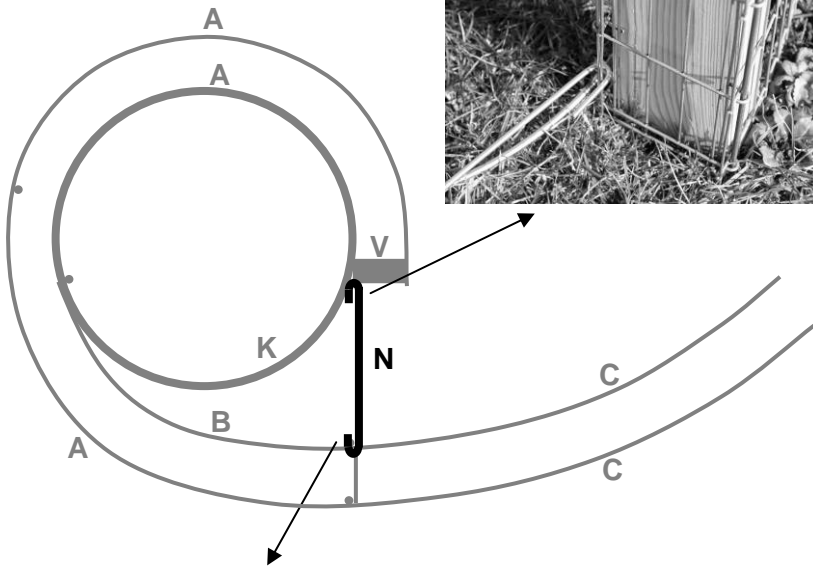

9.

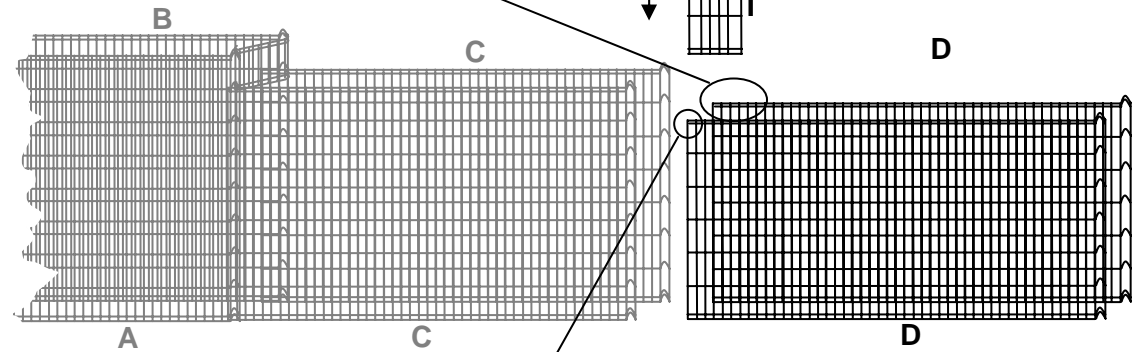
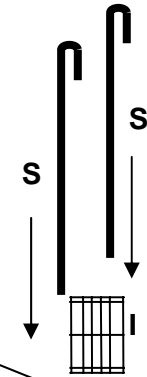
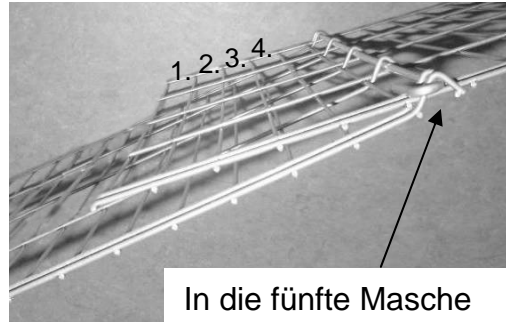
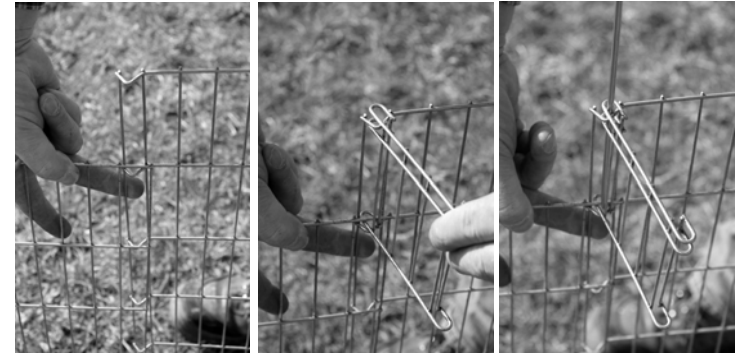

10.

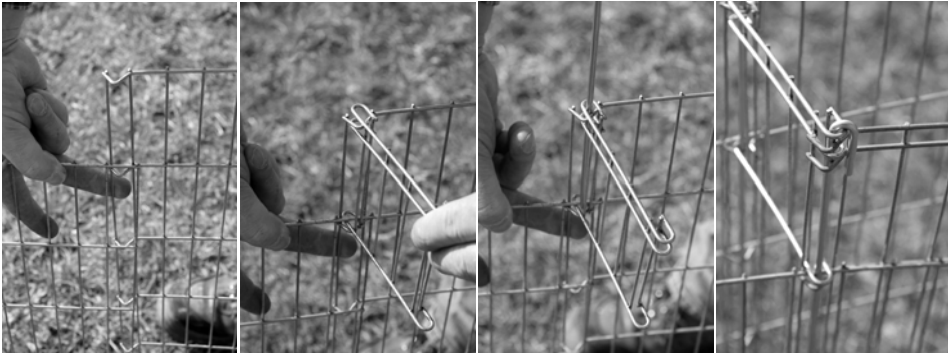

11.

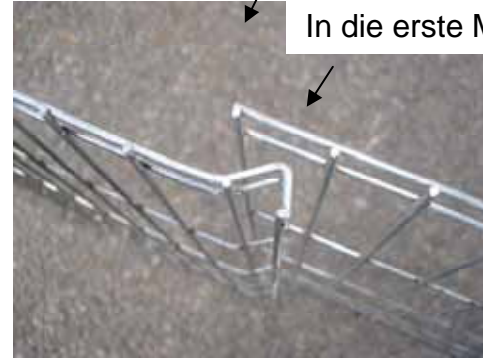
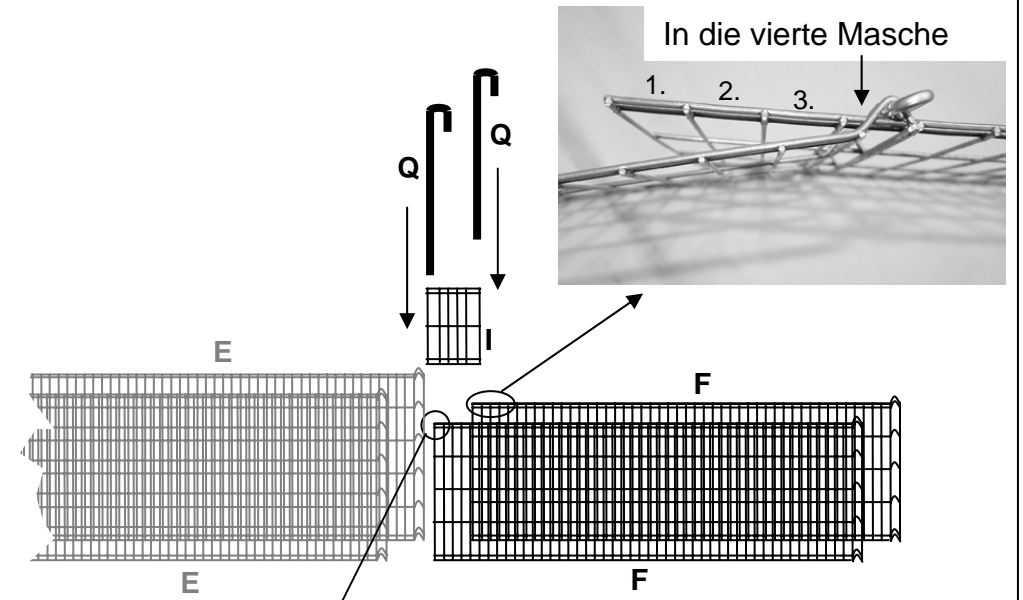
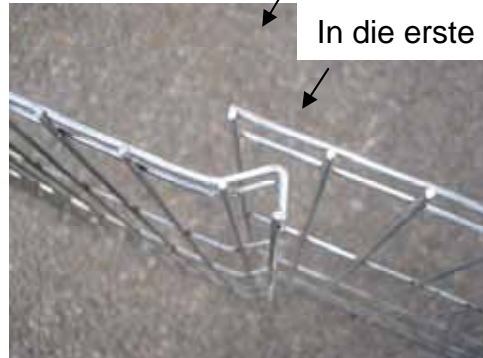
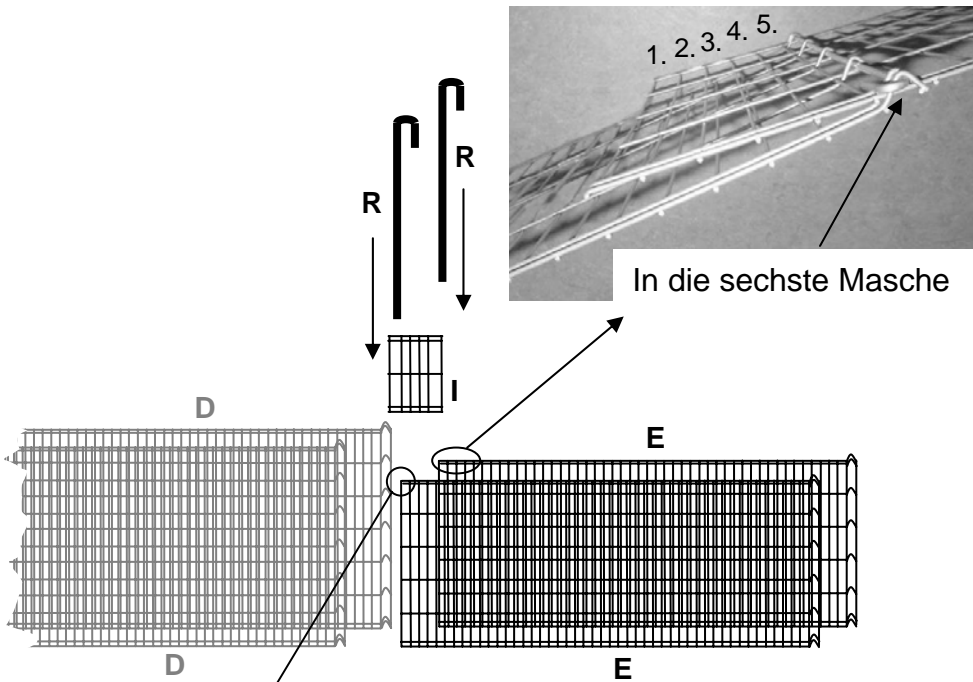
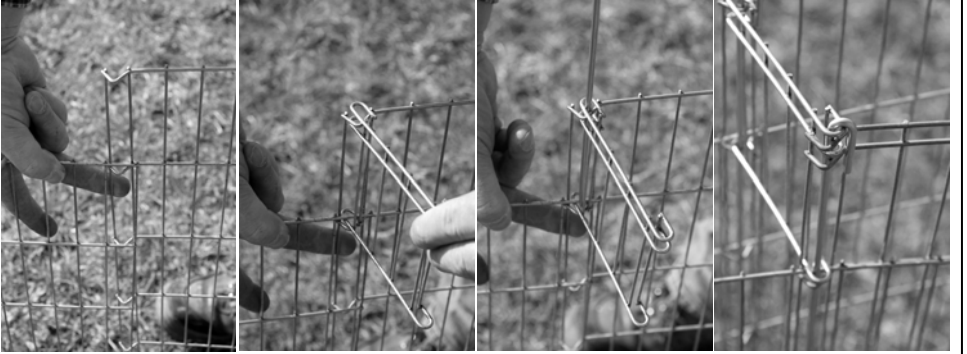

12.

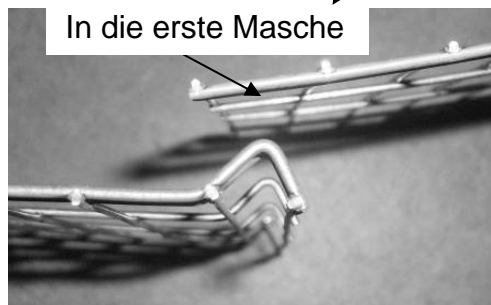
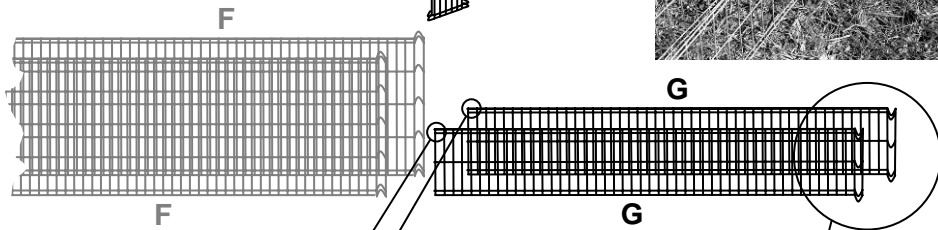
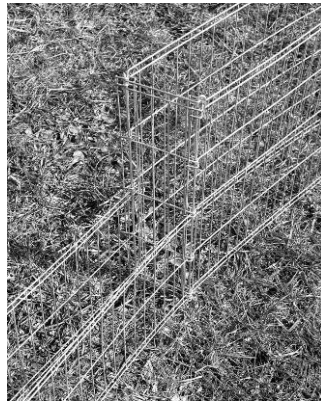
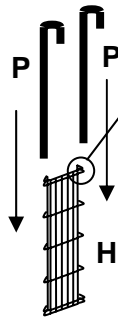

13.

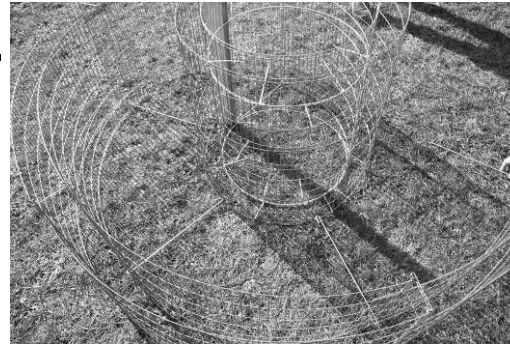

Die Haken immer an den Gitterverbindungsstellen anbringen. (a-d)

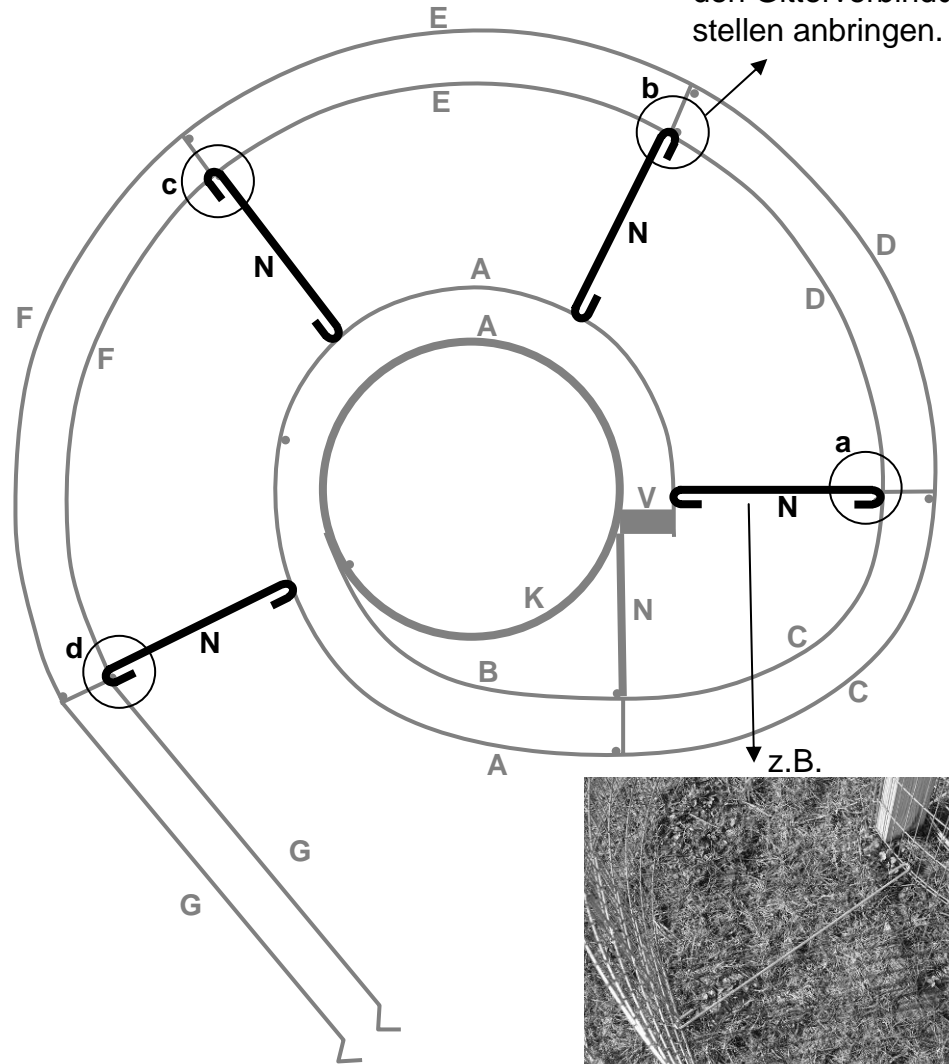

14. Die Kräuterspirale in der Form grob ausrichten. Die Haken (unten beginnend) versetzt in ca. jede 10. Masche (250mm) waagrecht mit den Gittern A beginnend, fortlaufend B,C, D, E, bis F einhaken. Senkrecht 200mm

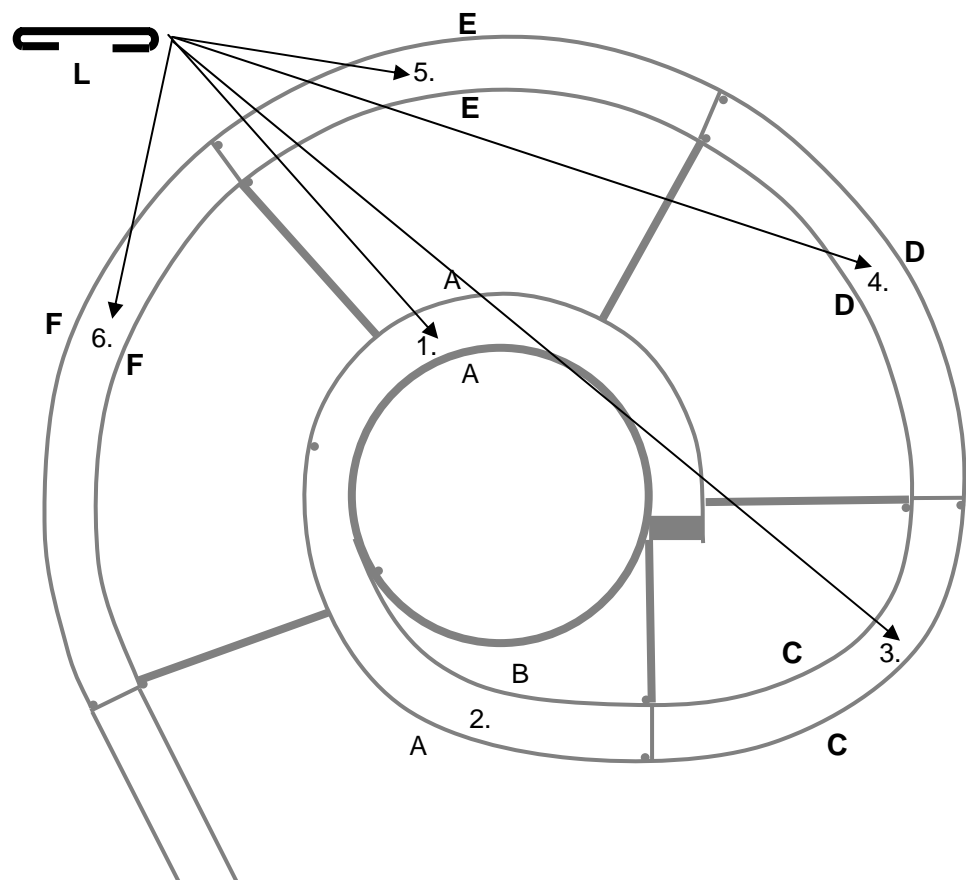
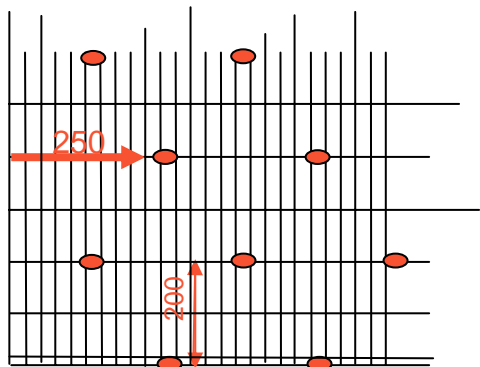

15.



Die Kräuterspirale bis zu den Gittern „F“ mit Steinen ein wenig befüllen. Noch mal die Form ausrichten und durch leichtes rütteln der Gitter die Steine etwas verdichten.



16.

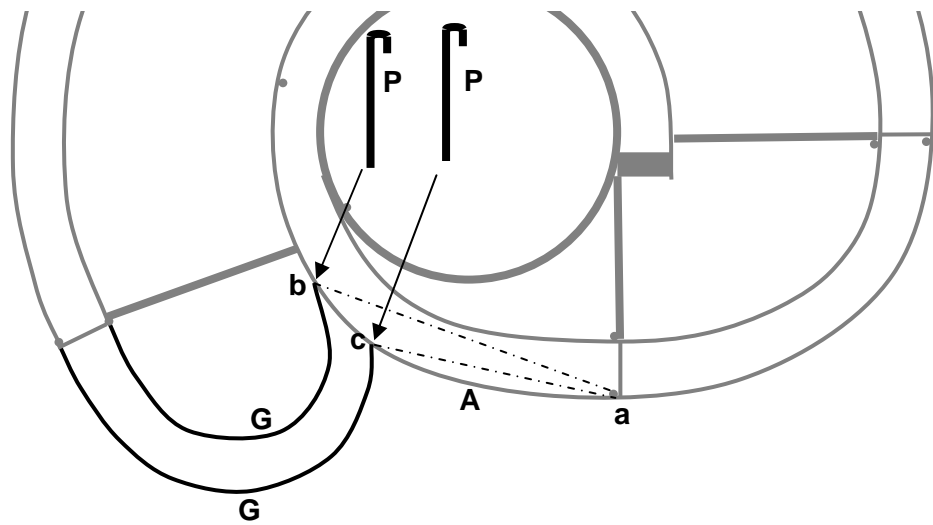

Die Gitter „G“ am Gitter „A“ wie folgt befestigen.
 Strecke a-b ist 34 Maschen.
 Strecke a-c ist 21 Maschen.



Die Haken gleichmäßig verteilen.

17.

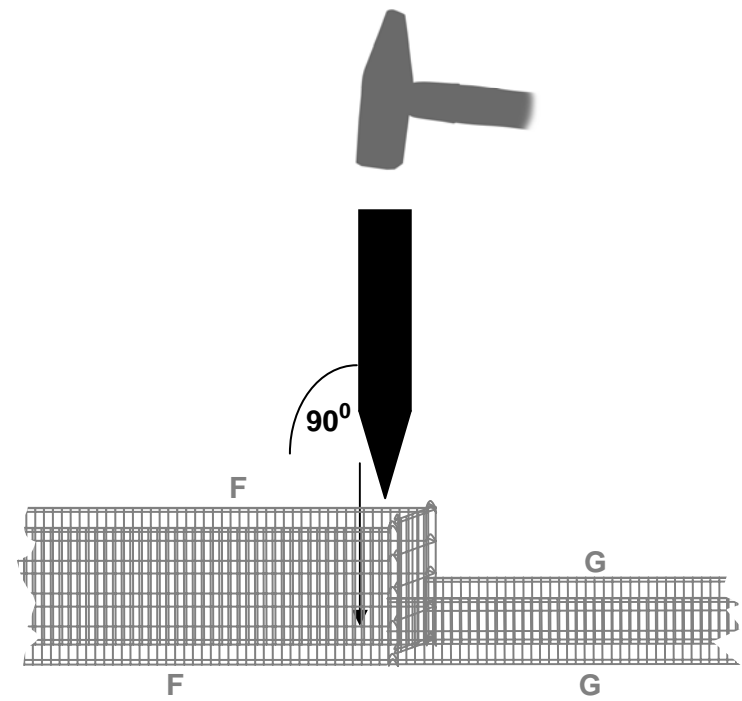

18.

Gleichmäßig rundherum auffüllen. Bis ca. 10 cm unter den oberen Rand.

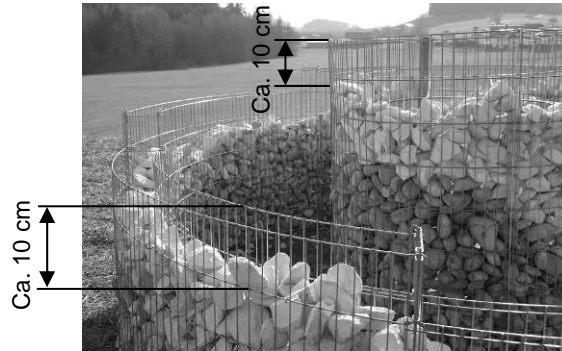
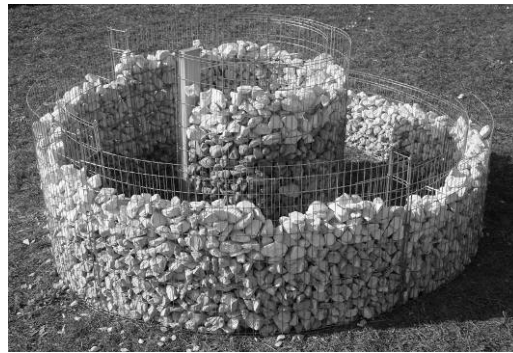

19 a.

Folien ca. 10 cm umschlagen, und mit den obersten Haken befestigen.

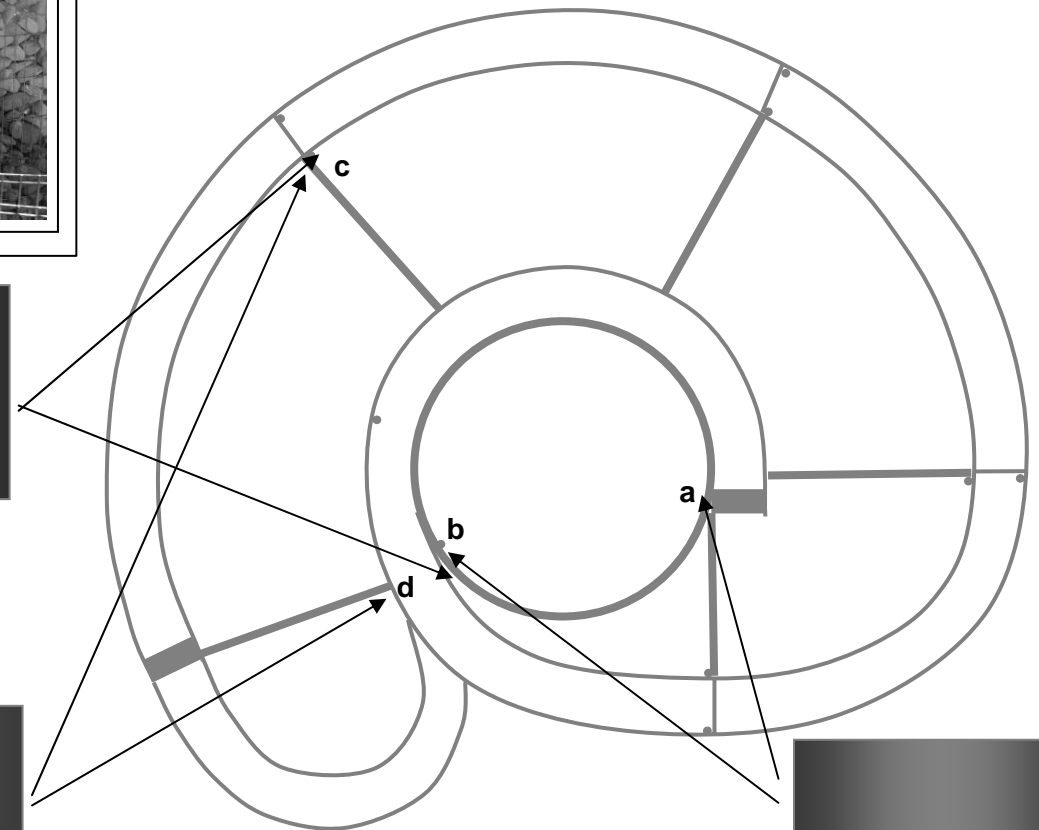

Die Folie „Y“ zwischen b und c einlegen. (siehe auch 20 b)

Y (89x380cm)

Die Folie „Z“ zwischen c und d einlegen.

Z (49x230cm)

Die Folie „W“ zwischen a und b einlegen.

W (89x130cm)

19 b.

Die Folie „Y“ muss an den Stufen mit einer Schere eingeschnitten werden.



21.

Die restlichen Steine, und die Erde einfüllen.

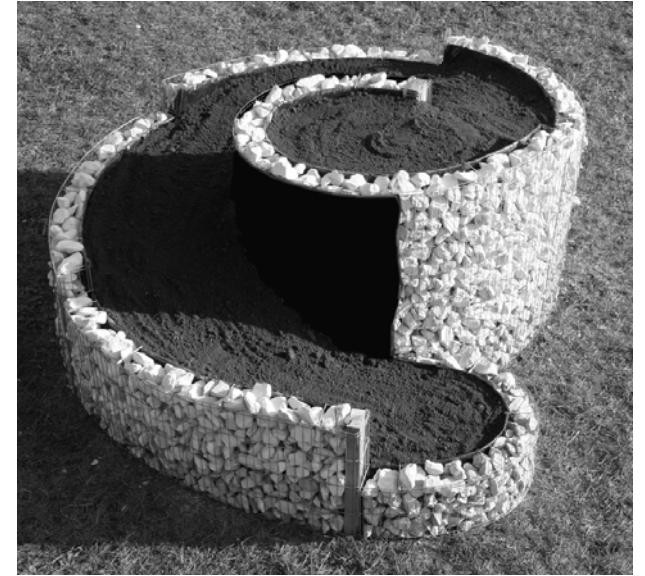

20.



X (89x170cm)

Die Folie „X“ einfach einlegen.



22.

Die Folie „X“ auf Höhe der Erde abschneiden.

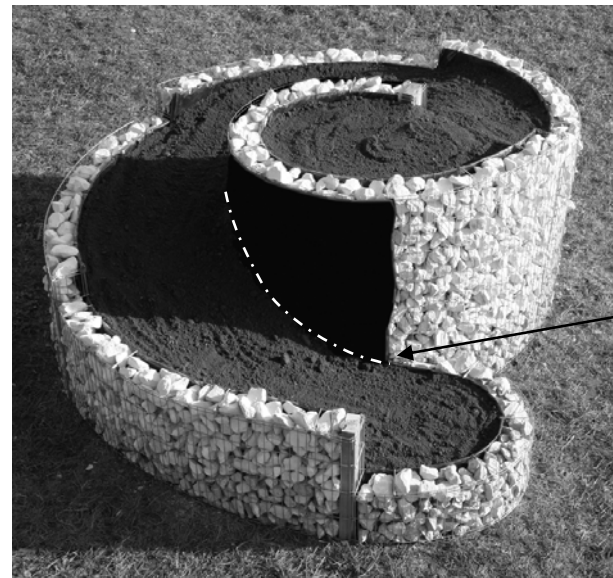

Bepflanzung der Kräuterspirale

1. Klimabereiche

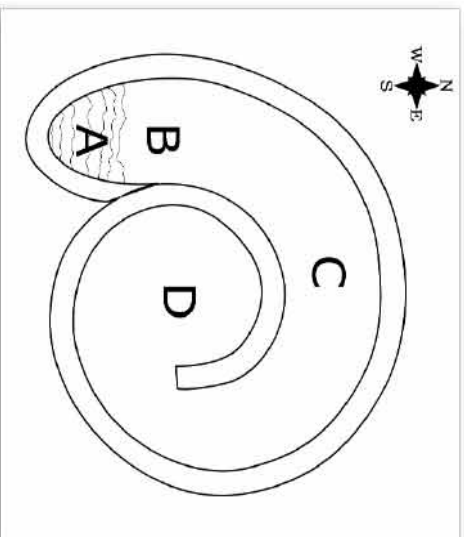

A Wasserbereich: entsteht durch anlegen eines Miteichs, der in Richtung Bereich "B" eine Verbindung zu seiner Umgebung haben soll;

B Feuchtbereich: liegt direkt im Anschluss an Bereich "A", durch die Kapillarwirkung der Erde ist es dort feucht;

C Normalbereich: durch die Nordlage halbschattig und trocken;

D Trockenbereich: durch die hohe Südlage sehr warm und sehr trocken;

2. Pflanzenliste (Beispiele)

Bereich A	Bereich B	Bereich C	Bereich D
Bachbunze Brunnenkresse Kalmus Sauerampfer Waldmeister Wassermintze	Dill Kamille (nahe an C) Kerbel Melisse (nahe an C) Petersilie Pfefferminze Sauerampfer Schnittlauch Wilde Rauke Zitronenmelisse	Basilikum Buschoregano Koriander Kümmel Pimpinelle Salbei (nahe an D) Weinraute	Bergbohnenkraut Currykraut Lavendel Majoran Orangenbthymian Oregano Rosmarin Thymian Ysop Zitronenthymian

3. Bodenbeschaffenheit

Bereich A	Bereich B	Bereich C	Bereich D
Miteich: aus Teichfolie oder einem Plastikbehälter; ca. 40 - 80 cm tief; im Wasser sind Steine und Sand zur Wärmespeicherung;	humusreich mit kompostierter Erde angereichert; die Erde soll das Wasser berühren;	Erd-Sandgemisch; (leichter Sandanteil)	hoher Sandanteil; kalkhaltig; unter der Erde Schutz oder Steine für eine bessere Drainage;;

4. Allgemeines

In einer Kräuterspirale treten wesentlich weniger Schädlinge auf als in normalen Beeten. Regenwürmer sind erwünschte Bewohner der Spirale. Die vielen Steine speichern die Sonnenwärme und geben sie langsam wieder ab, so dass sogar leichte Fröste abgefangen werden können. Hochwachsende Kräuter mit langen Wurzeln sollten nicht in die Kräuterspirale gepflanzt werden.