

**Technische Daten: Art.-Nr.: 871885**

**Wandaußenmaß: 830 x 360 cm**

**Bohlenstärke: 28 mm**



Kontrolliert durch:

Empty rectangular box for signature or name.

# 3D-Darstellung und Grundriss 871885

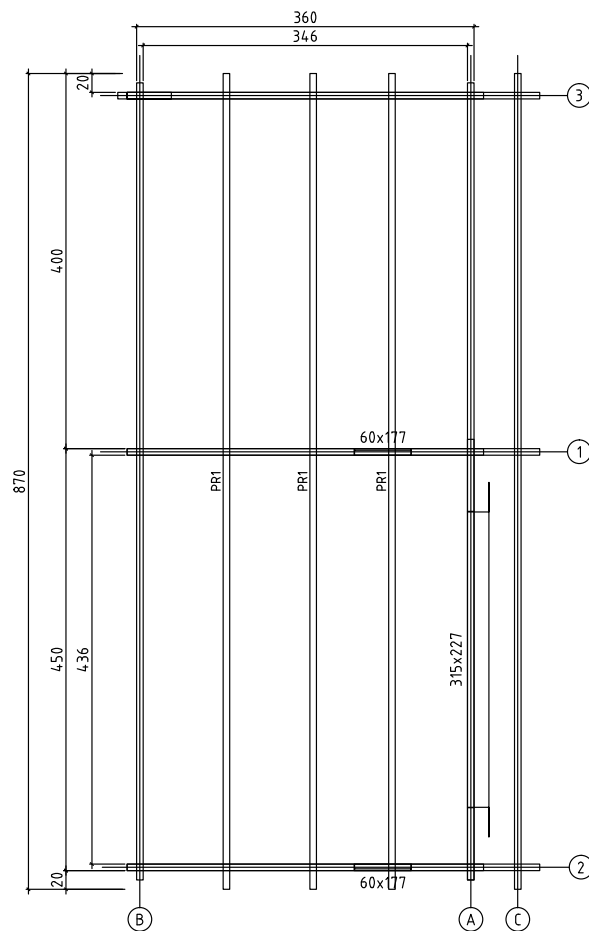
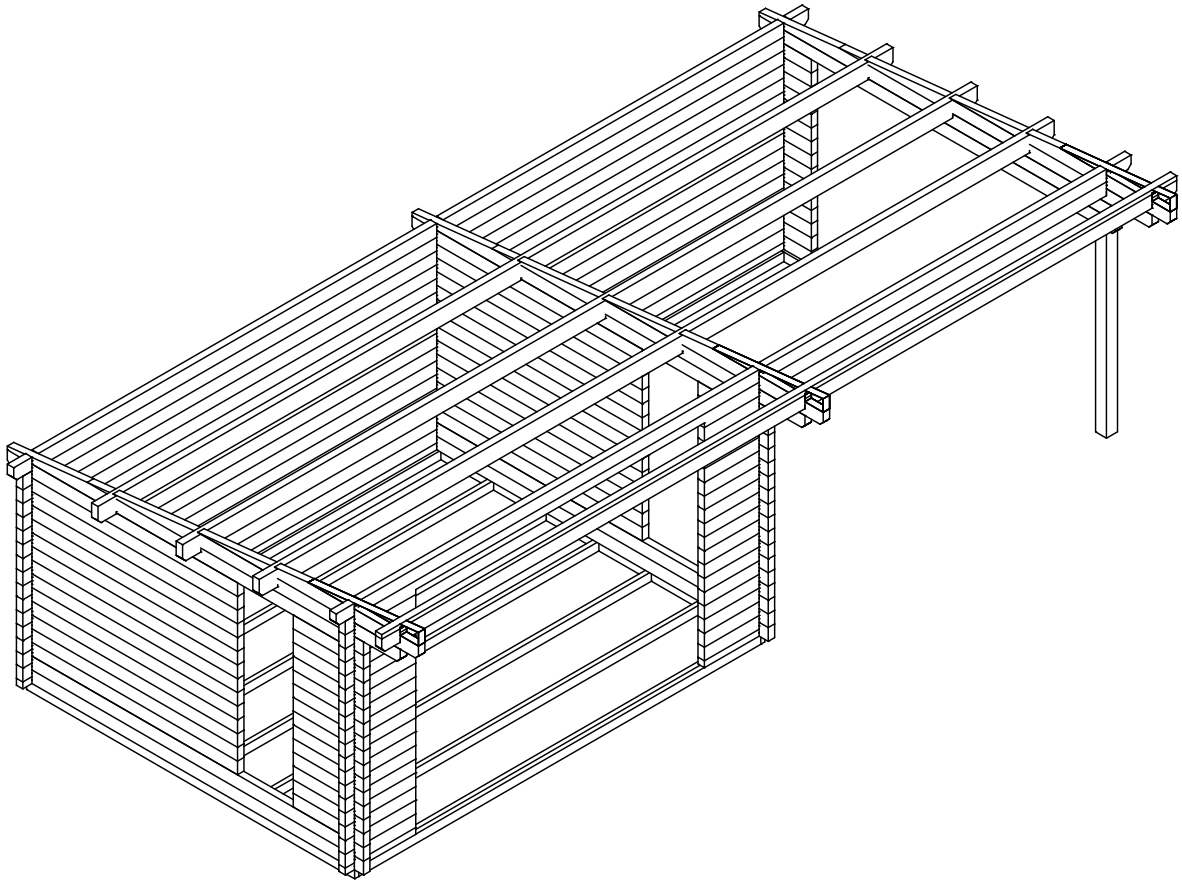

# Lagerholzplan und Fundamentplan 871885

Wir empfehlen als Fundament für Ihr Gartenhaus eine vollflächig festgegründete, gepflasterte oder betonierte Fläche.  
Wahlweise ist auch ein Punkt- oder Streifenfundament möglich.

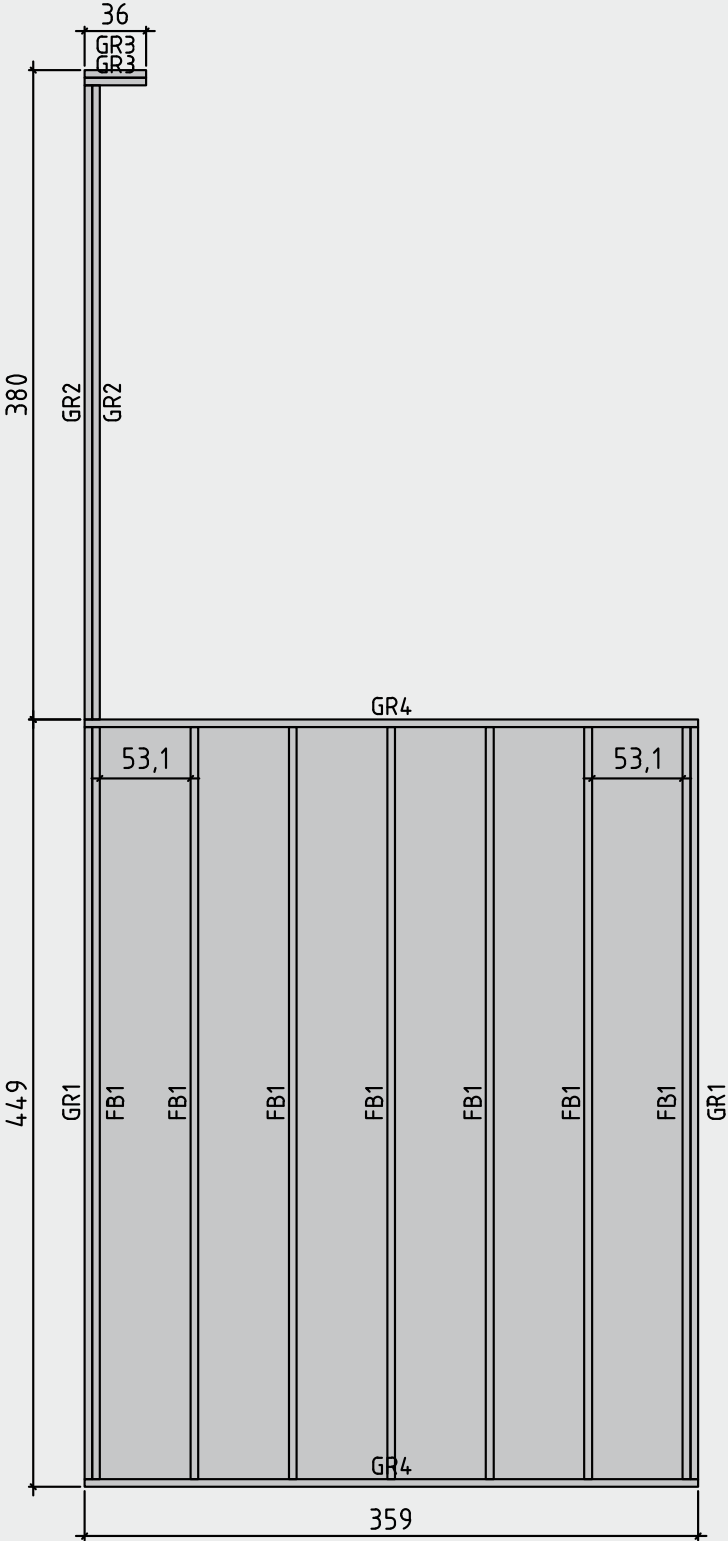





# Teileliste 1

## 871885

Pos		Quantity	Profil (mm)	Lenght (mm)
001		2	70x130	3800
002		2	70x130	3800
003		26	70x130	2420
004		62	70x130	770
005		2	70x130	2520
006		3	70x130	1129
007		2	70x130	2711
008		3	70x27	255
009		2	70x127	894
010		2	70x130	2187
011		3	70x87	811
012		3	70x130	1576
013		3	70x130	1209
014		1	70x130	470
015		14	70x130	470
016		1	70x130	3900
017		1	70x130	2711
018		1	70x127	894
019		1	70x130	2187
020		2	70x65	770
021		1	70x130	8500
022		1	70x120	8700
023		1	70x65	4565
024		1	70x65	3935
025		1	70x130	8500

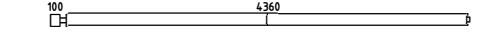
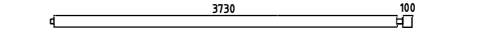
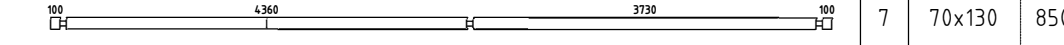
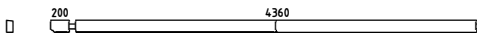
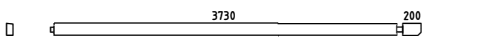
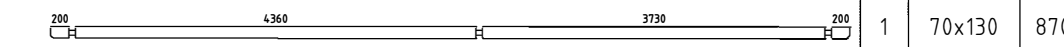

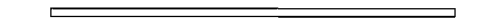
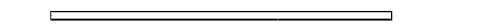
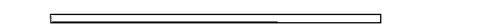

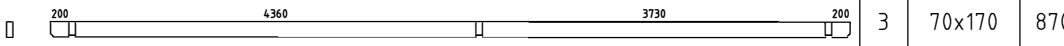





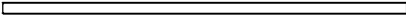





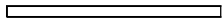

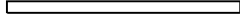

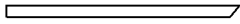

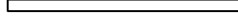

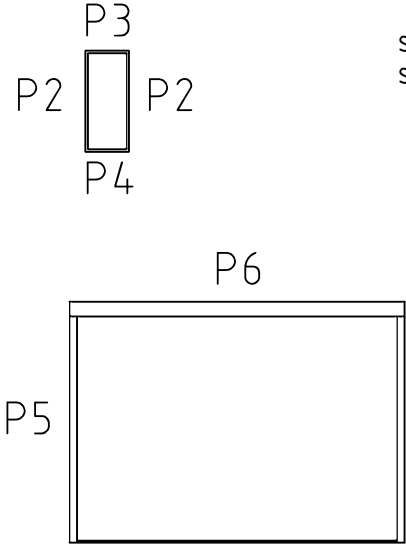
# Teileliste 2

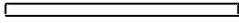
## 871885

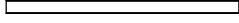
Pos	Diagramm	Quantity	Profil (mm)	Lenght (mm)
026		7	70x130	4565
027		7	70x130	3935
028		7	70x130	8500
029		1	70x130	4665
030		1	70x130	4035
031		1	70x130	8700
032		1	70x43	8700
GR1	Rahmen-Fundamentholz 	2	45x90	4400
GR2	Rahmen-Fundamentholz 	2	45x90	3710
GR4	Rahmen-Fundamentholz 	2	45x90	3590
GR3	Rahmen-Fundamentholz 	2	45x90	360
FB1	Fundamentholz 	7	45x90	4400
PR1	Pfetten 	3	70x170	8700
	Fenster 600x1770	2		
	Tür 3150x2270	1		

# Teileliste 3

## 871885

POS	ST.	B	H	L	
FB1	Vt. spetsi				 FUNDMENTHOLZER 
F1	15,1m <sup>2</sup>	28		3455	 FUSSBODENBRETTER
PR	3	70	170	8700	 DACHBALKEN 
RB1	39,4m <sup>2</sup>	20		4526	 DACHBRETTER
R1	4	20	140	4370	 Traufenbretter 
R2	4	45	65	4350	 Traufenbretter 
R3	2	20	140	4720	 Giebelabschlussleiste 
R4	2	20	90	4720	 Giebelabschlussleiste 
PS1	1	120	120	2000	 Pfosten für Seitendach 
WN06	2	600	1770		 <p>Schiebelamellen 30x30x2150 mm - 2 Stk. Schiebelamellen 30x30x1720 mm - 4 Stk.</p> <p>70x140x3150 mm - 1 pcs. 70x70x2130 mm - 2 pcs. 20x70x3010 mm - 1 pcs.</p>
P1	17m	20	40		 Fußbodenleiste
P2	4+4	20	90	1920	 Fensterleiste WN 06 
P3	2+2	20	90	900	 Fensterleiste WN 06 
P4	2+2	20	90	<del>540</del> 570	 Fensterleiste WN 06 
P5	4+4	20	90	2150	 Türleiste 
P6	2+2	20	90	3600	 Türleiste 

# Wandplan 1 und 2 871885

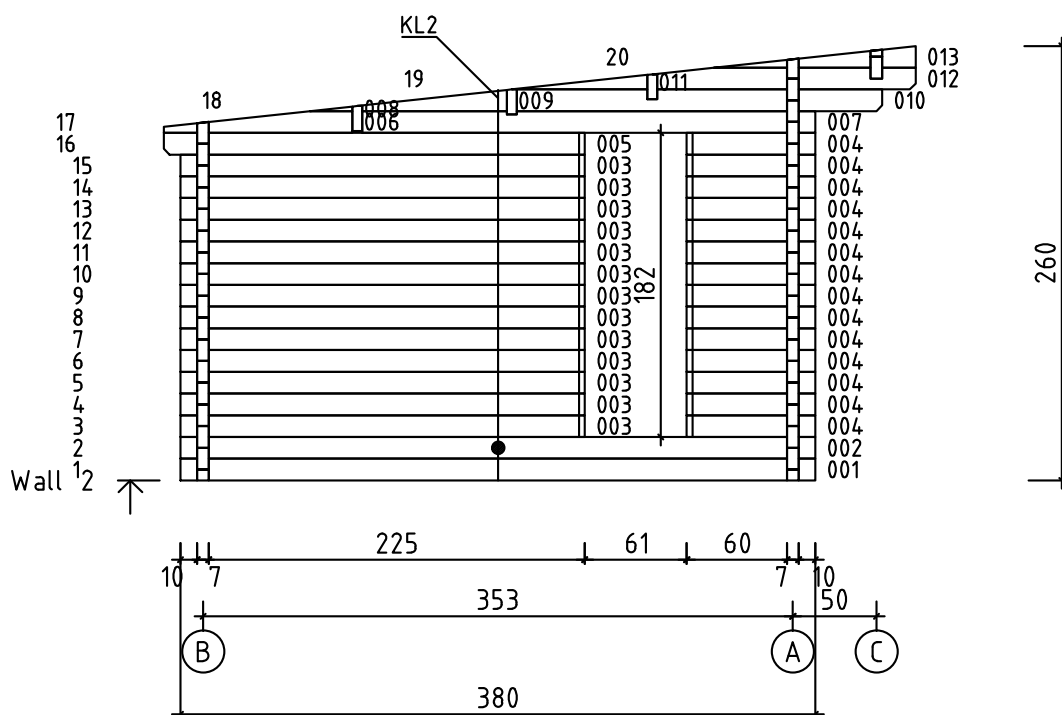
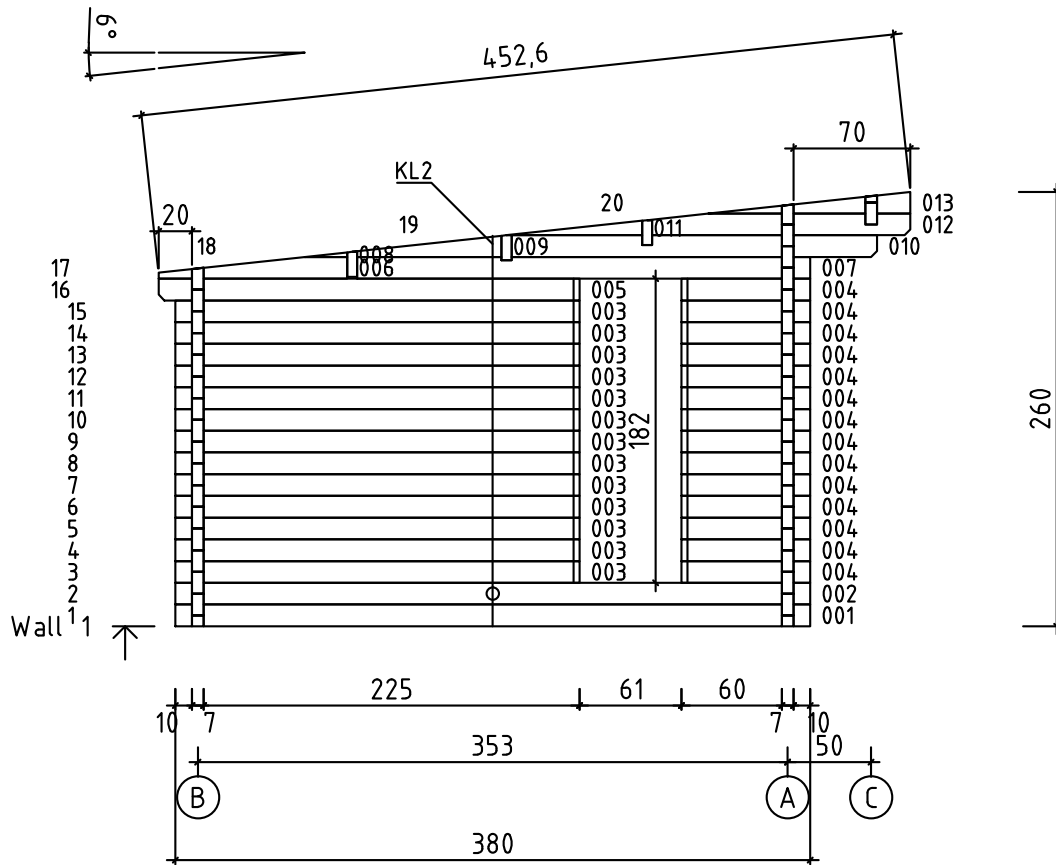

# Wandplan 3 871885

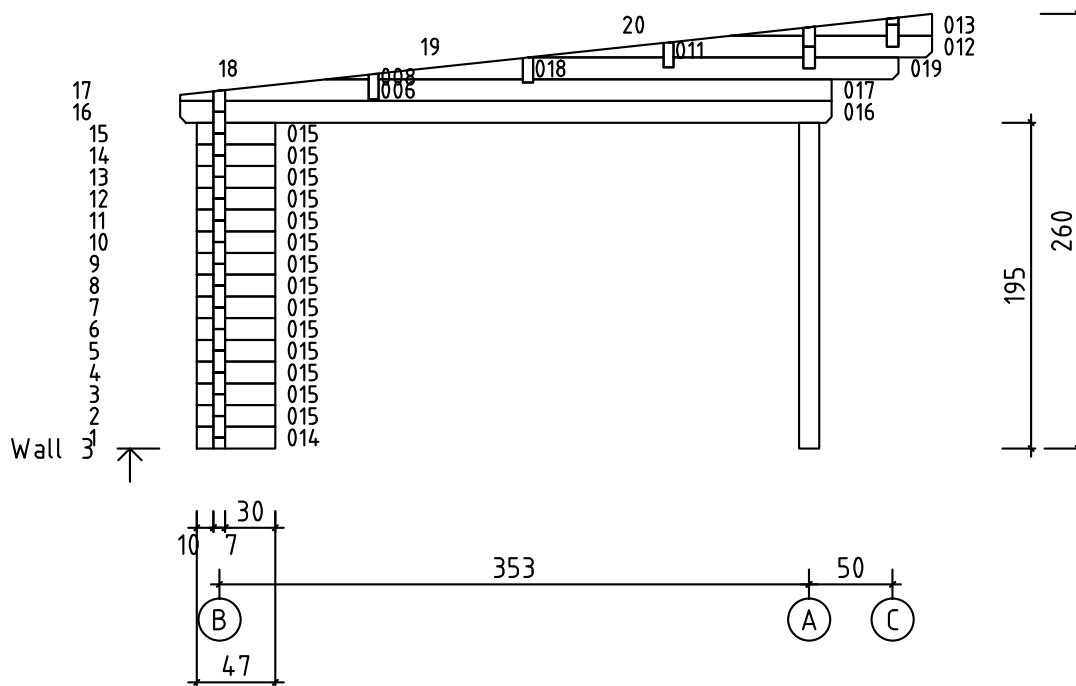



# Wandplan A 871885

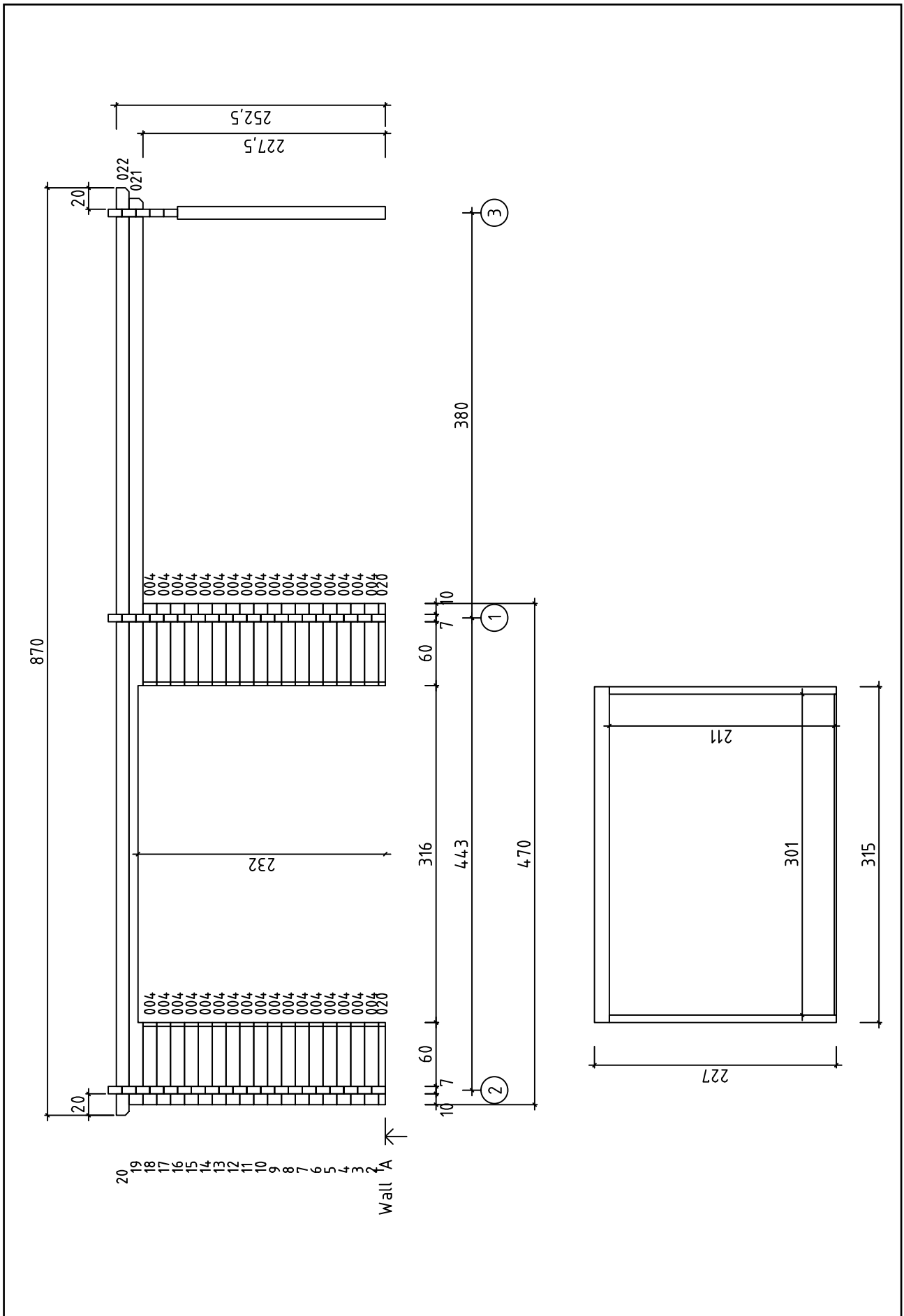

# Wandplan B 871885

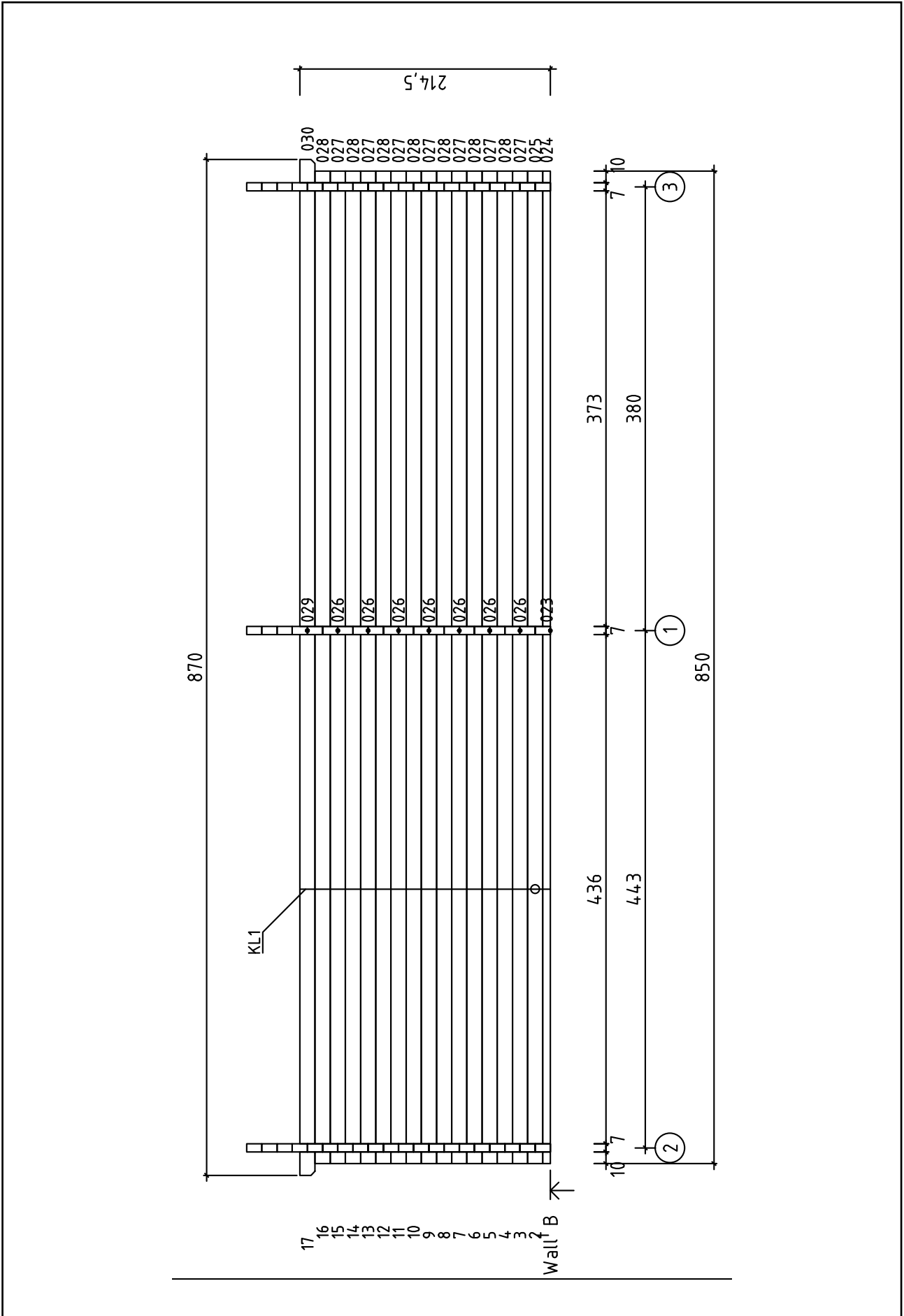

# Wandplan C

## 871885

