

# Technische Daten

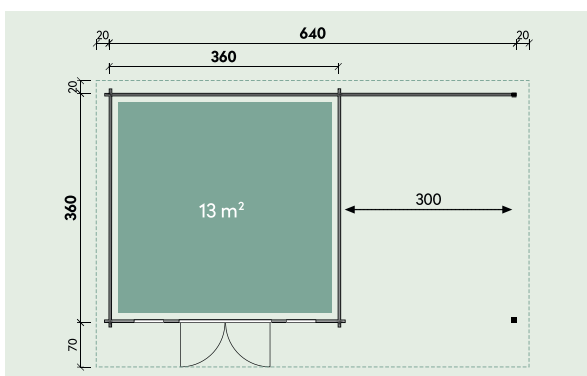

## Artikelnummer:

871 852



**Kontrolliert durch:**

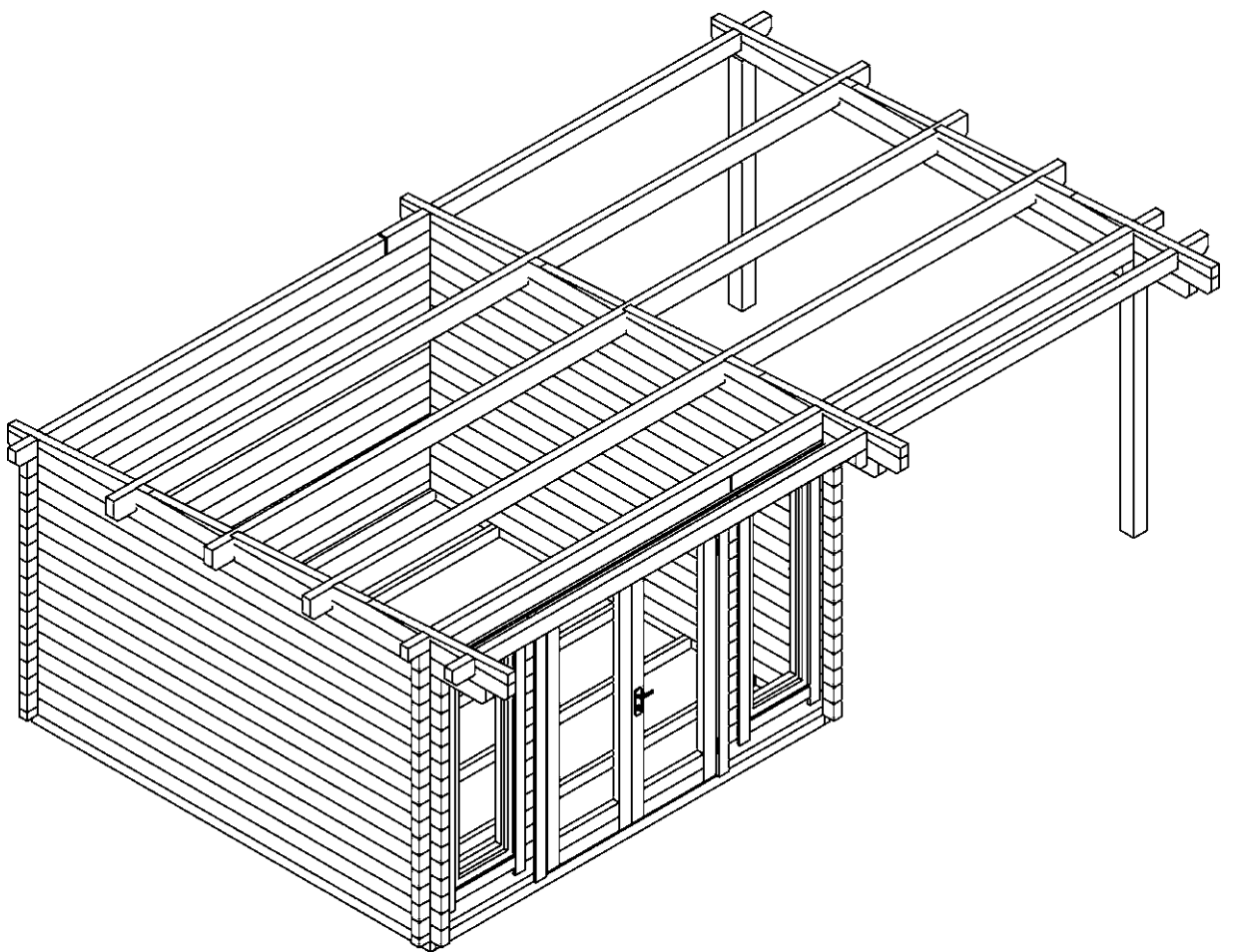

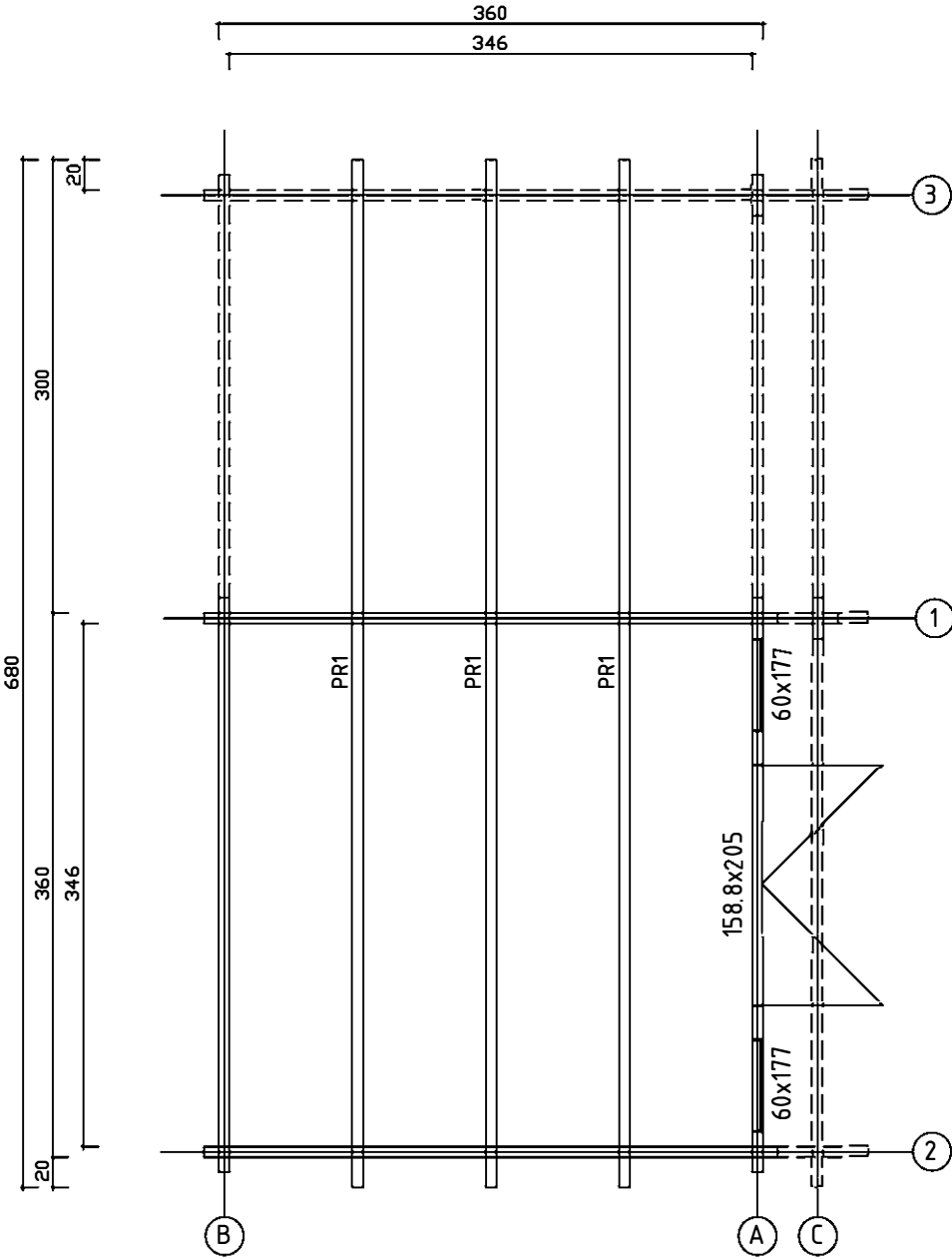



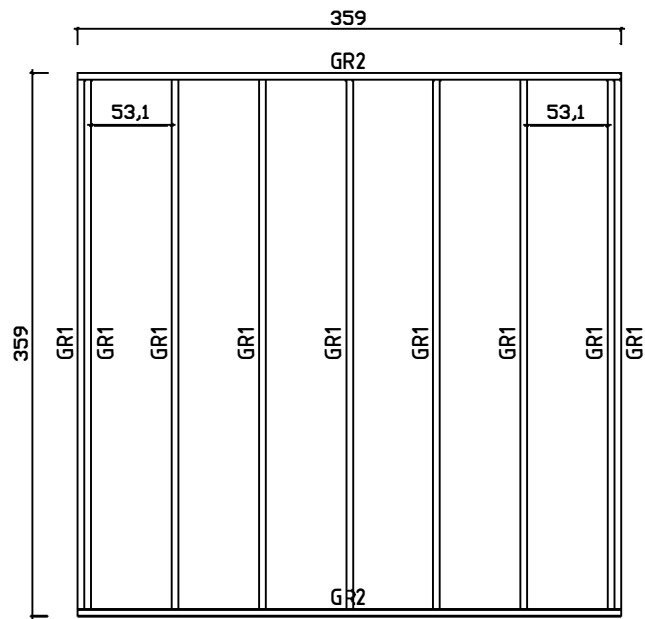







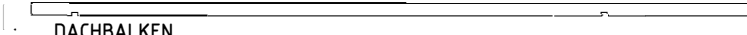

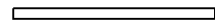

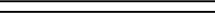

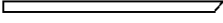

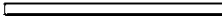





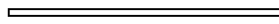
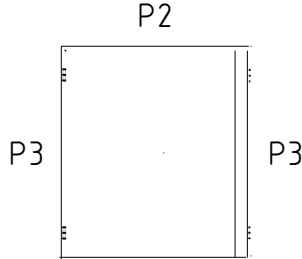
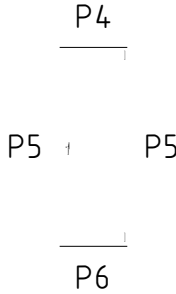

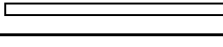
**Wir empfehlen als Fundament für Ihr Gartenhaus eine vollflächig festgegründete, gepflasterte oder betonierte Fläche. Wahlweise ist auch ein Punkt- oder Streifenfundament möglich.**

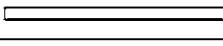

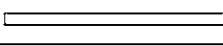
Nr.		Stck.	Profil (mm)	Lenght (mm)
001		2	70x130	3800
002		3	70x130	3800
003		40	70x130	3800
004		2	70x130	3900
005		3	70x119	1088
006		3	70x130	822
007		1	70x130	2270
008		3	70x47	717
009		3	70x106	853
010		1	70x130	1588
011		3	70x85	1283
012		2	70x130	2270
013		2	70x130	1588
014		1	70x130	3900
015		2	70x65	1101
016		2	70x130	1101
017		2	70x130	1101
018		26	70x130	270
019		26	70x130	221
020		1	70x130	3800
021		2	70x130	270
022		1	70x130	2817
023		1	70x130	3798
024		1	70x104	3765
025		1	70x104	3035

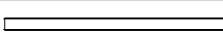
Nr.		Stück	Profil (mm)	Lenght (mm)
026		1	70x65	3800
027		1	70x130	3338
028		1	70x130	3477
029		1	70x130	3765
030		1	70x130	3035
031	=	1	70x29	60
032	=	2	70x29	60
GR2		2	45x90	3590
GR1		9	45x90	3500
PR1		3	70x170	6800
	WINDOW 600x1770	2		
	DOOR 1588x2050	1		
1	Screws/Schrauben/Vis 5x100 mm- For fixing first row of wall logs /Fixierung des ersten Bohlenkranzes/Pour fixer les lamesde plancher	6		
2	Nails/Nägel/Clous 2.5x50 - For fixing floorboards/ Befestigung Fussbodenbretter/Pour fixer les lames de plancher	300		
3	Nails/Nägel/Clous 2.5x50 - For fixing roofboards/ Befestigung Dachbretter/Pour fixer les voliges	450		
4	Nails/Nägel/Clous 2.5x50 - For fixing floor edge trims/ Befestigung Fussleisten/Pour fixer les plinthes du plancher	40		
5	Nails/Nägel/Clous 2.5x50 - For fixing roofing felt fillet/ Befestigung giebelabschlussbrett/Pour fixer la latte de finition de la couverture	30		
6	Screws/Schrauben/Vis 2,5x50 mm- For fixing roof side boards and roof edge reinforcement Befestigung Traufenbretter und Traufenleisten Pour fixer les planches de rive et le tasseau de refront	175		
7	Screws/Schrauben/Vis 2,5x50 mm- For fixing fascia boards and diamonds/ Befestigung Giebelblende und Raute Pour fixer les planches de rive et le diamant			
8	Screws/Schrauben/Vis 2,5x50 mm- For fixing fwindow and door trims/ Befestigung Fenster und türen/ Pour fixer les croisillons des fenetres et des portes			
9	Metal storm Brace/Gewindestange/Tige filetee 8 mm	3		
10	Shim/Nuts/Mutter ,U-Scheibe/Ecrou,Rondelle 8 mm For fixing storm braces/ Pour fixer les anti tempefe/ Für Sturmleisten Pour fixer les croisillons des fenetres et des portes Metal storm Brace/Gewindestange/Tige filetee 8 mm KL1 M8 2,24 m 1 Screws 180 6 pcs. KL2 M8 2,21 m 2 Plastic caps 3 pcs.	3/3		
11	Roofing felt/Dachpappe/Feutre de toiture	10+10+15		
12	Nails/Nägel/Clous - For fixing roofing felt/ Befestigung Dachpappe/Pour fixer les feutre de toiture	310		
13	Screws/Schrauben/Vis 4.5x70 mm PR1	12		
14	Screws/Schrauben/Vis 6x180 mm	4		

POS	ST.	B	H	L	
GR1	Vt. spetsi				 FUNDMENTHOLZER
F1	12m <sup>2</sup>	28		3455	 FUSSBODENBRETTER
PR	3	70	170	6800	 DACHBALKEN
RB1	30,7m <sup>2</sup>	20		4510	 DACHBRETTER
R1	4	20	140	3420	Vaara kaluse kaldenurka  Traufenbretter 
R2	4	45	65	3400	Vaara kaluse kaldenurka  Traufenbretter 
R3	2	20	140	4700	Vaara kaluse kaldenurka  Giebelabschlussleiste 
R4	2	20	90	4700	 Giebelabschlussleiste 
DP			10+10+15		DACHPAPPE + NÄGEL (310)
SK	2	70	65		 SCHLAGKLOTZ 
PS	2	<del>90</del> 120	<del>90</del> 120	2020	 POST 
SL	4	30	30	1600	 SLIDING SLATS 
DR1	1	1588	2050		
WN1	2	600	1770		
P1	15m	20	40		 Fußbodenleiste
P2	1+1	20	90	1890	 Türleiste DR1 
P3	2+2	20	90	2030	 Türleiste DR1 
P4	2+2	20	90	900	 Fensterleiste WN1 
P5	4+4	20	90	1920	 Fensterleiste WN1 
P6	2+2	20	90	540 570	 Fensterleiste WN1 