

Technische Daten

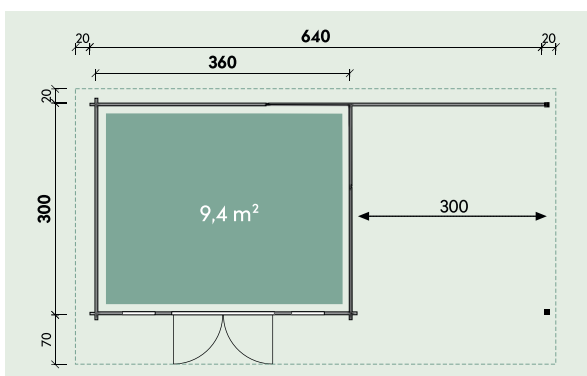

Artikelnummer:

871 851



Kontrolliert durch:

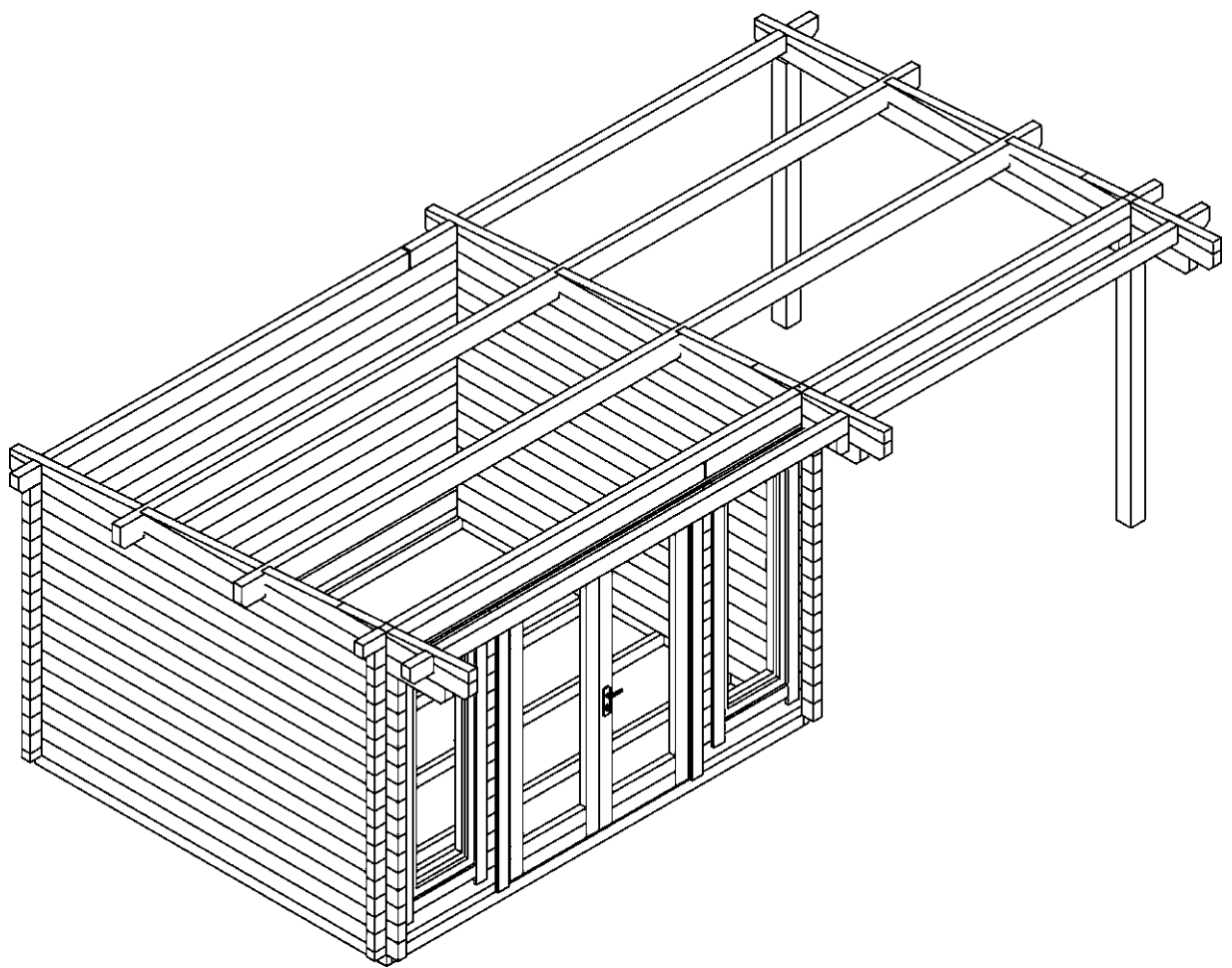

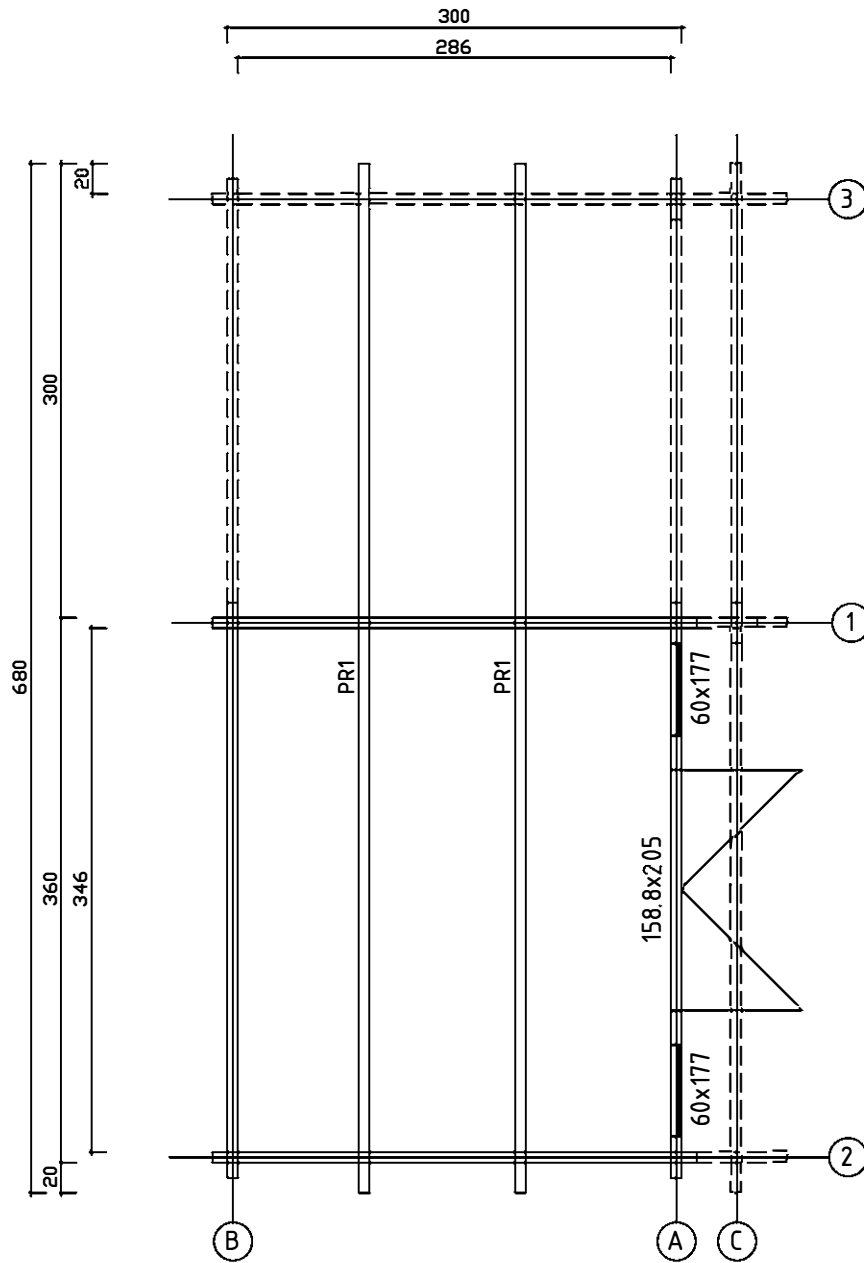



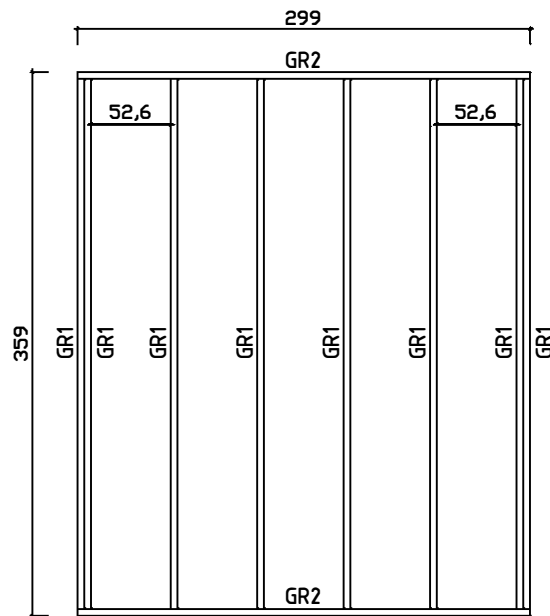



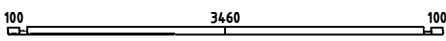
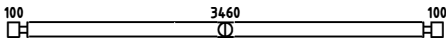
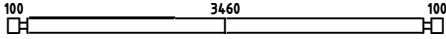
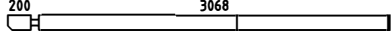
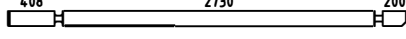
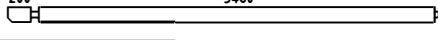
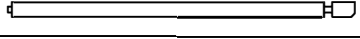
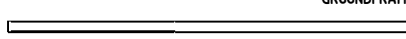
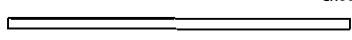
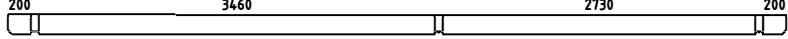







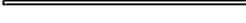











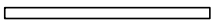



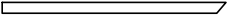

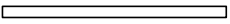





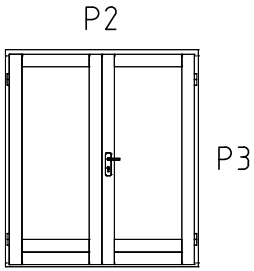

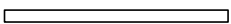

Wir empfehlen als Fundament für Ihr Gartenhaus eine vollflächig festgegründete, gepflasterte oder betonierte Fläche. Wahlweise ist auch ein Punkt- oder Streifenfundament möglich.

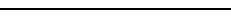

Nr.		Stück	Profil (mm)	Lenght (mm)
001		2	70x130	3200
002		2	70x130	3200
003		26	70x130	3200
004		2	70x130	3300
005		3	70x128	1072
006		1	70x130	2568
007		2	70x78	1001
008		1	70x130	1766
009		3	70x88	1133
010		1	70x130	2568
011		2	70x130	1766
012		1	70x130	3300
013		1	70x130	2568
014		1	70x78	1001
015		2	70x65	1101
016		2	70x130	1101
017		2	70x130	1101
018		26	70x130	270
019		26	70x130	221
020		1	70x130	3800
021		2	70x130	270
022		1	70x130	2817
023		1	70x130	3798
024		1	70x99	3765
025		1	70x99	3035

Nr.		Stck.	Profil (mm)	Length (mm)
026		1	70x65	3800
027		1	70x130	3800
028		14	70x130	3800
029		1	70x130	3338
030		1	70x130	3477
031		1	70x130	3765
032		1	70x130	3035
GR1		8	45x90	3500
GR2		2	45x90	2990
PR1		2	70x170	6800
	WINDOW 600x1770	2		
	DOOR 1588x2050	1		
1	Screws/Schrauben/Vis 5x100 mm- For fixing first row of wall logs /Fixierung des ersten Bohlenkranzes/Pour fixer les lamesde plancher 	6		
2	Nails/Nägel/Clous 2.5x50 - For fixing floorboards/ Befestigung Fussbodenbretter/Pour fixer les lames de plancher 	250		
3	Nails/Nägel/Clous 2.5x50 - For fixing roofboards/ Befestigung Dachbretter/Pour fixer les voliges 	400		
4	Nails/Nägel/Clous 2.5x50 - For fixing floor edge trims/ Befestigung Fussleisten/Pour fixer les plinthes du plancher 	30		
5	Nails/Nägel/Clous 2.5x50 - For fixing roofing felt fillet/ Befestigung giebelabschlussbrett/Pour fixer la latte de finition de la couverture 	30		
6	Screws/Schrauben/Vis 2,5x50 mm- For fixing roof side boards and roof edge reinforcement Befestigung Traufenbretter und Traufenteisten Pour fixer les planches de rive et le tasseau de refront 	175		
7	Screws/Schrauben/Vis 2,5x50 mm- For fixing fascia boards and diamonds/ Befestigung Giebelblende und Raute Pour fixer les planches de rive et le diamant 			
8	Screws/Schrauben/Vis 2,5x50 mm- For fixing fwindow and door trims/ Befestigung Fenster und Türen/ Pour fixer les croisillons des fenetres et des portes 			
9	Metal storm Brace/Gewindestange/Tige filetee 8 mm 	3		
10	Shim/Nuts/Mutter ,U-Scheibe/Ecrou/Rondelle 8 mm For fixing storm braces/ Pour fixer les anti tempete/ Für Sturmleisten Pour fixer les croisillons des fenetres et des portes  Metal storm Brace/Gewindestange/Tige filetee 8 mm KL1 M8 2,39 m 2 Screws 180 6 pcs. KL2 M8 2,25 m 1 Plastic caps 3 pcs.	3/3		
11	Roofing felt/Dachpappe/Feutre de toiture	10+10+15		
12	Nails/Nägel/Clous - For fixing roofing felt/ Befestigung Dachpappe/Pour fixer les feutre de toiture 	270		
13	Screws/Schrauben/Vis 4.5x70 mm PR1 	8		
		4		

POS	ST.	B	H	L	
GR1	Vt. spetsi				 FUNDMENTHOLZER
F1	9,9m ²	28		2855	 FUSSBODENBRETTER
PR	2	70	170	6800	 DACHBALKEN
RB1	26,6m ²	20		3912	 DACHBRETTER
R1	4	20	140	3420	Vaata kafuse kaldenurka  Traufenbretter 
R2	4	45	65	3400	Vaata kafuse kaldenurka  Traufenbretter 
R3	2	20	140	4120	Vaata kafuse kaldenurka  Giebelabschlussleiste 
R4	2	20	90	4120	 Giebelabschlussleiste 
DP			10+10+15		DACHPAPPE + NÄGEL (270)
SK	2	70	65		 SCHLAGKLOTZ 
PS	2	90 120	90 120	2020	 POST 
SL	4	30	30	1600	 SLIDING SLATS 
DR1	1	1588	2050		 P2 P3 P3
WN1	2	600	1770		 P4 P5 P5 P6
P1	14m	20	40		 Fussbodenleiste
P2	1+1	20	90	1890	 Türleiste DR1 
P3	2+2	20	90	2030	 Türleiste DR1 
P4	2+2	20	90	900	 Fensterleiste WN1 
P5	4+4	20	90	1920	 Fensterleiste WN1 
P6	2+2	20	90	540 570	 Fensterleiste WN1 