

# Technische Daten

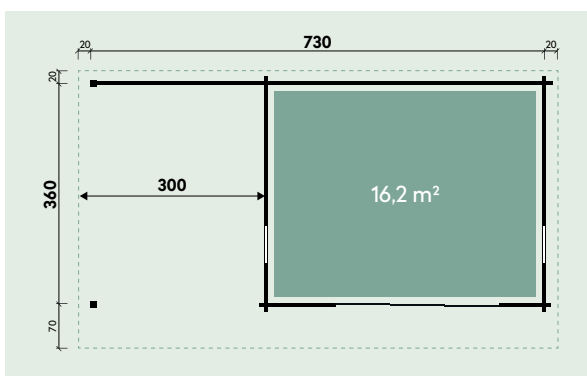

## Artikelnummer:

871 808



Kontrolliert durch:

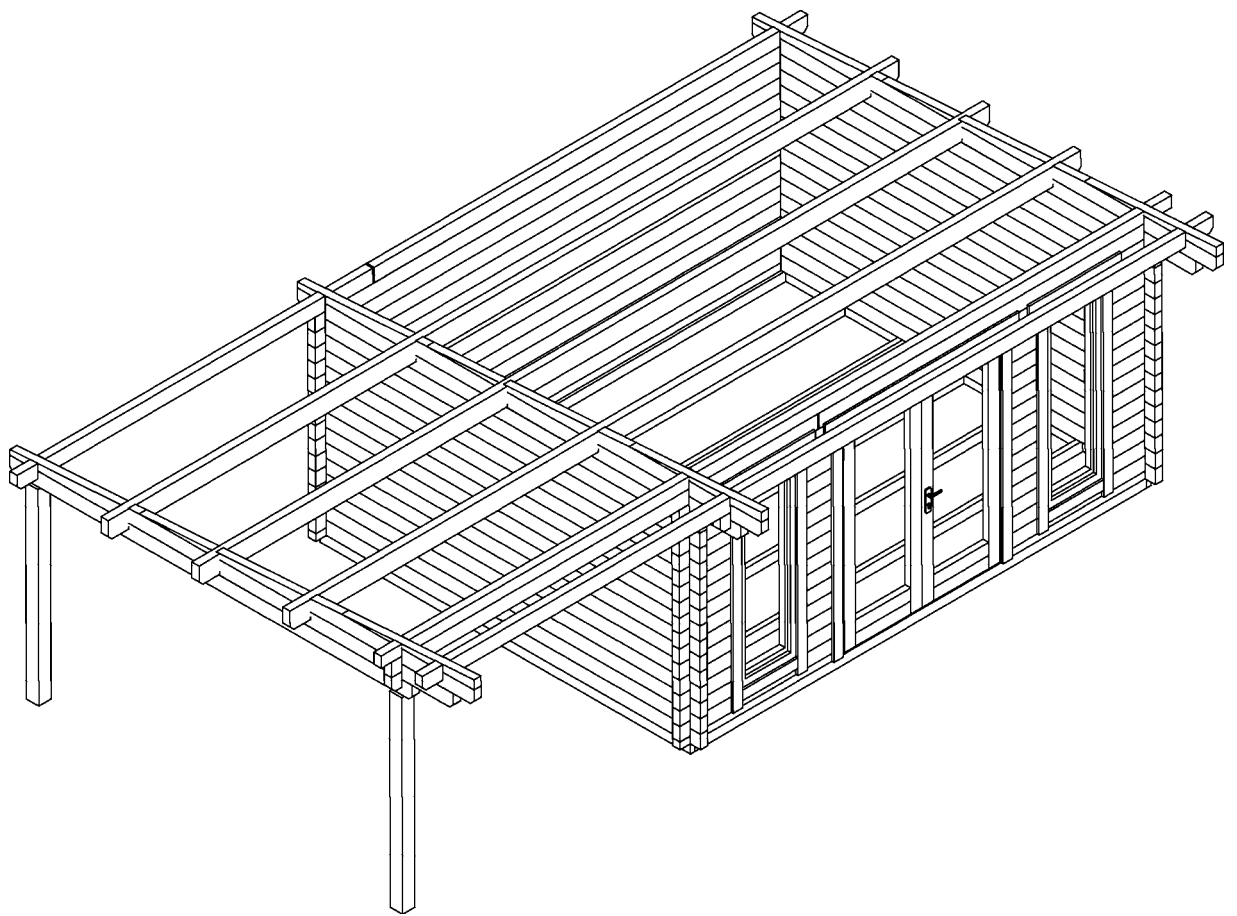

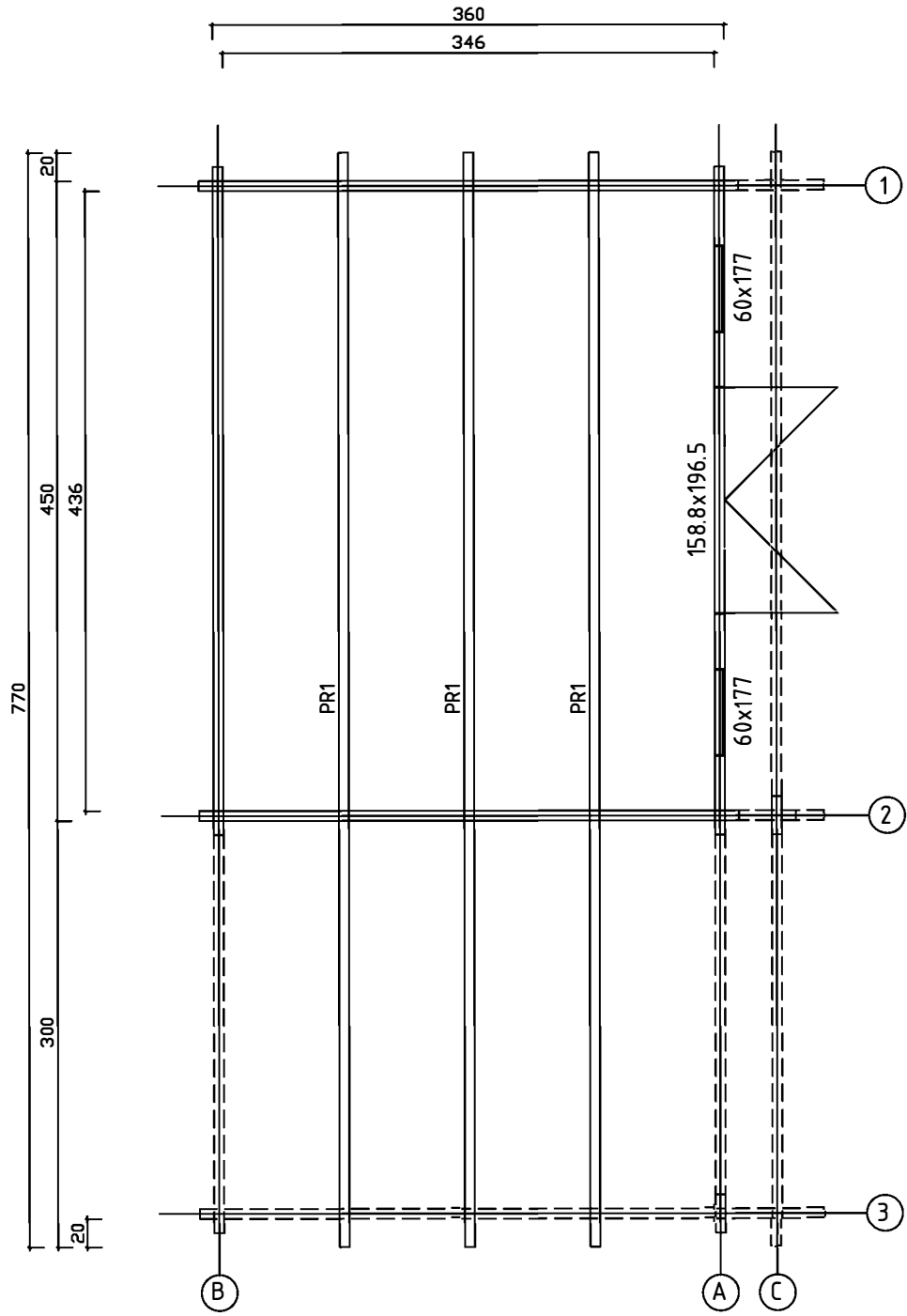



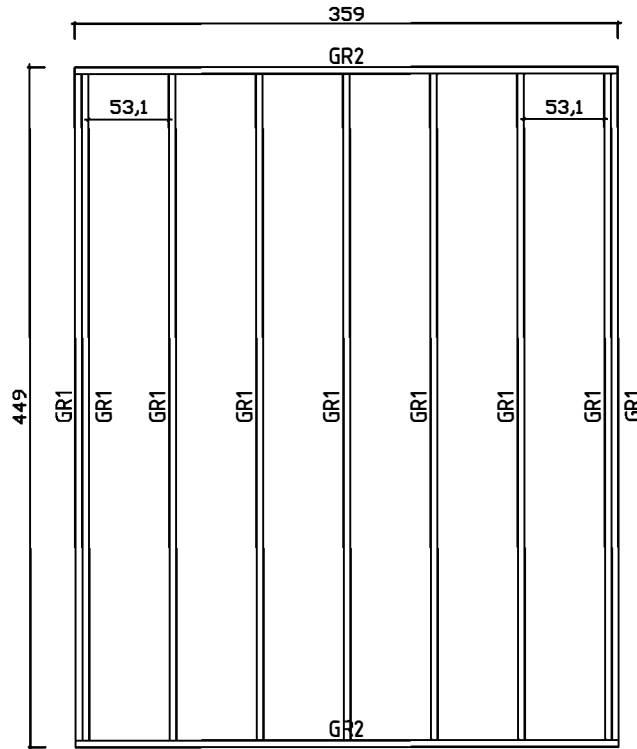









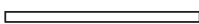



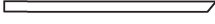







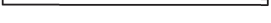
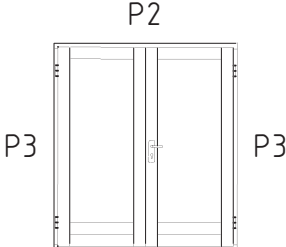
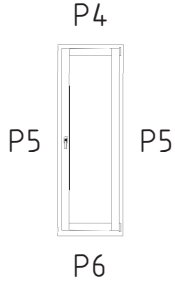

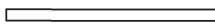
**Wir empfehlen als Fundament für Ihr Gartenhaus eine vollflächig festgegründete, gepflasterte oder betonierte Fläche. Wahlweise ist auch ein Punkt- oder Streifenfundament möglich.**

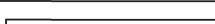

Nr.	Stück	Profil (mm)	Length (mm)
001	2	70x130	3800
002	26	70x130	3800
003	2	70x130	3900
004	3	70x119	1088
005	3	70x130	823
006	2	70x130	2270
007	3	70x47	718
008	3	70x106	853
009	2	70x130	1588
010	3	70x85	1283
011	1	70x130	2270
012	1	70x130	1588
013	1	70x130	3900
014	2	70x65	1551
015	1	70x130	1551
016	1	70x130	1551
017	28	70x130	555
018	28	70x130	386
019	2	70x130	270
020	1	70x130	4166
021	1	70x130	3349
022	1	70x104	3035
023	1	70x104	4665
024	1	70x65	4700
025	1	70x130	4700

Nr.		Stck	Profil (mm)	Lenght (mm)
026		13	70x130	4700
027		1	70x130	3478
028		1	70x130	4238
029		1	70x130	3035
030		1	70x130	4665
031	-	3	70x29	60
GR1		9	45x90	4400
GR2		2	45x90	3590
PR1		3	70x170	7700
	WINDOW 600x1770	2		
	DOOR 1588x1965	1		
1	Screws/Schrauben/Vis 5x100 mm- For fixing first row of wall logs /Fixierung des ersten Bohlenkranzes/Pour fixer les lamesde plancher	6		
2	Nails/Nägel/Clous 2.5x50 - For fixing floorboards/ Befestigung Fussbodenbretter/Pour fixer les lames de plancher	350		
3	Nails/Nägel/Clous 2.5x50 - For fixing roofboards/ Befestigung Dachbretter/Pour fixer les voliges	550		
4	Nails/Nägel/Clous 2.5x50 - For fixing floor edge trims/ Befestigung Fussleisten/Pour fixer les plinthes du plancher	40		
5	Nails/Nägel/Clous 2.5x50 - For fixing roofing felt fillet/ Befestigung giebelabschlussbrett/Pour fixer la latte de finition de la couverture	30		
6	Screws/Schrauben/Vis 2,5x50 mm- For fixing roof side boards and roof edge reinforcement Befestigung Traufenbretter und Traufenleisten Pour fixer les planches de rive et le tasseau de refront	175		
7	Screws/Schrauben/Vis 2,5x50 mm- For fixing fascia boards and diamonds/ Befestigung Giebelblende und Raute Pour fixer les planches de rive et le diamant			
8	Screws/Schrauben/Vis 2,5x50 mm- For fixing fwindow and door trims/ Befestigung Fenster und türen/ Pour fixer les croisillons des fenestres et des portes			
9	Metal storm Brace/Gewindestange/Tige filetee 8 mm	4		
10	Shim/Nufs/Mütter -U-Scheibe/Ecrou/Rondelle 8 mm For fixing storm braces/ Pour fixer les anti tempete/ Für Sturmleisten Pour fixer les croisillons des fenestres et des portes Metal storm Brace/Gewindestange/Tige filetee 8 mm KL1 M8 2,12 m 2 Screws 180 8 pcs. KL2 M8 2,35 m 2 Plastic caps 4 pcs.	4/4		
11	Roofing felt/Dachpappe/Feutre de toiture	10+15+15		
12	Nails/Nägel/Clous - For fixing roofing felt/ Befestigung Dachpappe/Pour fixer les feutre de toiture	350		
13	Screws/Schrauben/Vis 4.5x70 mm PR1	12		
14	Screws/Schrauben/Vis 6x180 mm	4		

POS	ST.	B	H	L	
GR1	Vt. spetsi				 FUNDMENTHOLZER
F1	15,1m <sup>2</sup>	28		3455	 FUSSBODENBRETTER
PR	3	70	170	7700	 DACHBALKEN
RB1	34,7m <sup>2</sup>	20		4510	 DACHBRETTER
R1	4	20	140	3870	Vaata kätuse käldeuruka  Traufenbretter 
R2	4	45	65	3850	Vaata kätuse käldeuruka  Traufenbretter 
R3	2	20	140	4700	Vaata kätuse käldeuruka  Giebelabschlussleiste 
R4	2	20	90	4700	 Giebelabschlussleiste 
DP			10+15+15		DACHPAPPE + NÄGEL (350)
SK	2	70	65		 SCHLAGKLOTZ 
PS	2	90 120	90 120	1900	 PFOSTEN 
SL	4	30	30	1720	 SLIDING SLATS 
DR1	1	1588	1965		 P2 P3 P3
WN1	2	600	1770		 P4 P5 P5 P6
P1	17m	20	40		 Fußbodenleiste
P2	1+1	20	90	1890	 Türleiste DR1 
P3	2+2	20	90	1945	 Türleiste DR1 
P4	2+2	20	90	900	 Fensterleiste WN1 
P5	4+4	20	90	1920	 Fensterleiste WN1 
P6	2+2	20	90	540 570	 Fensterleiste WN1 