

Technische Daten

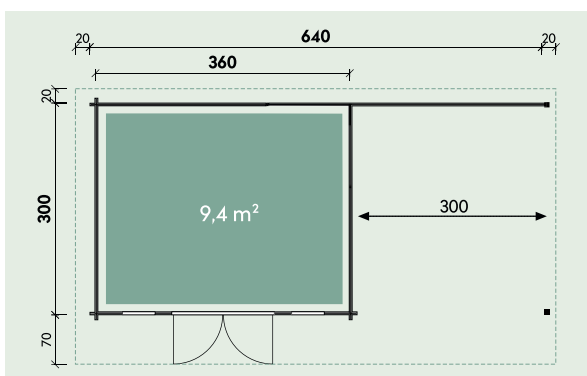

Artikelnummer:

871 801



Kontrolliert durch:

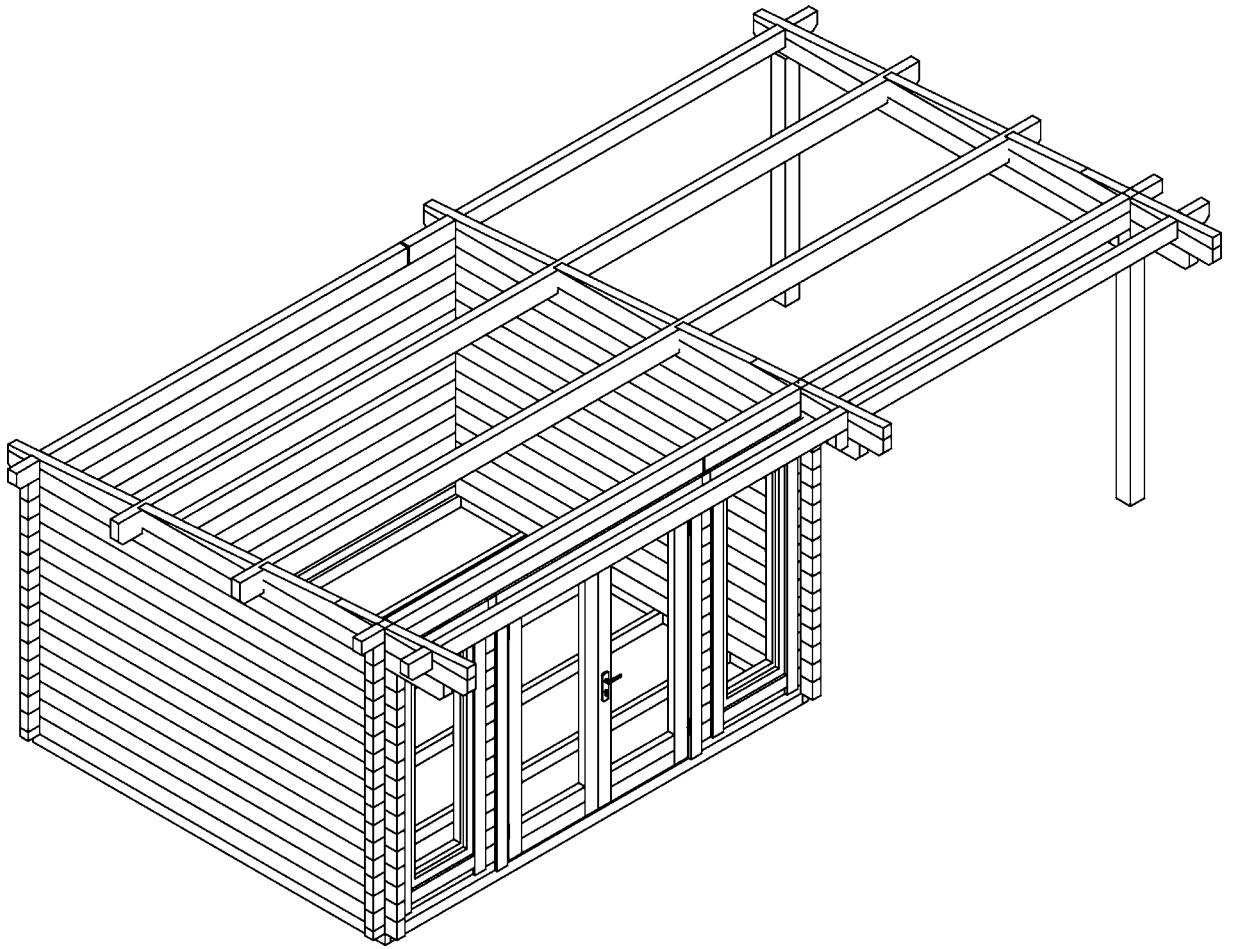

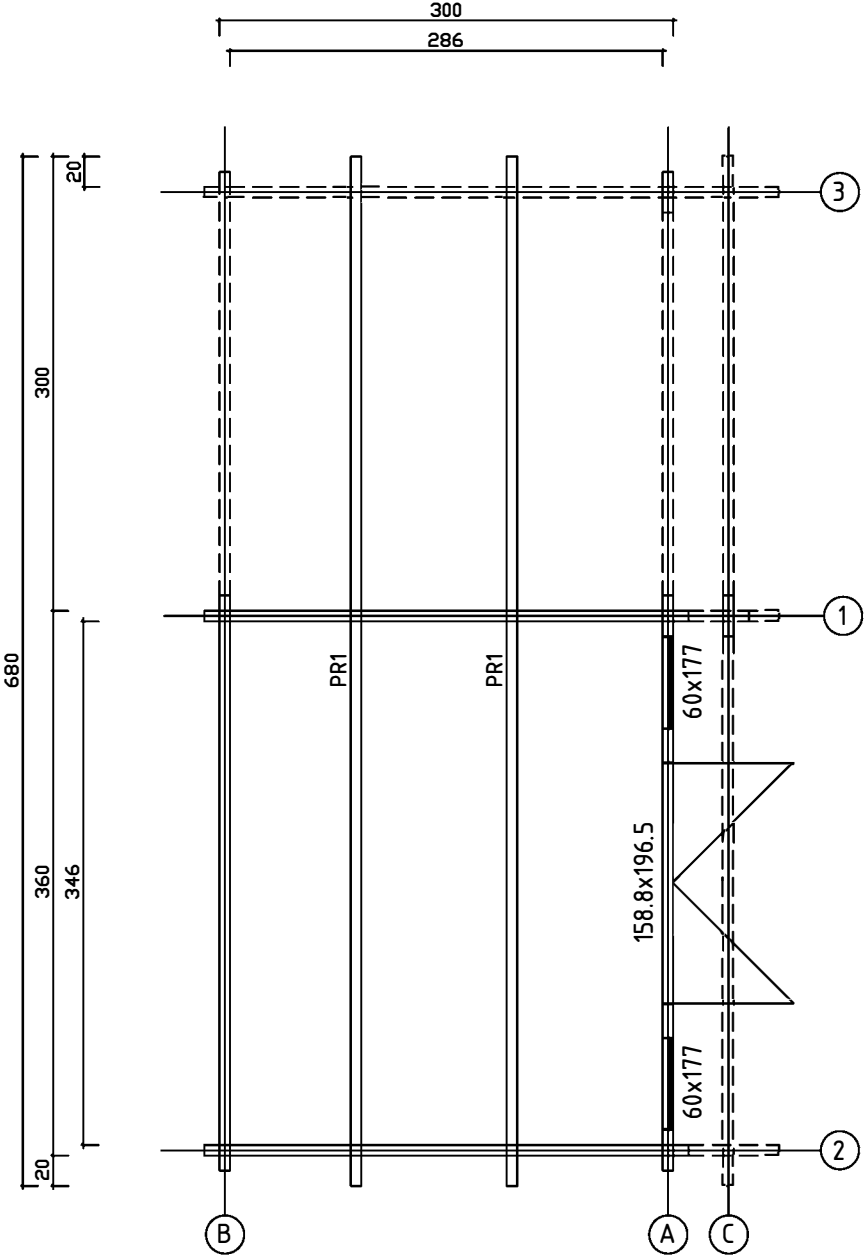



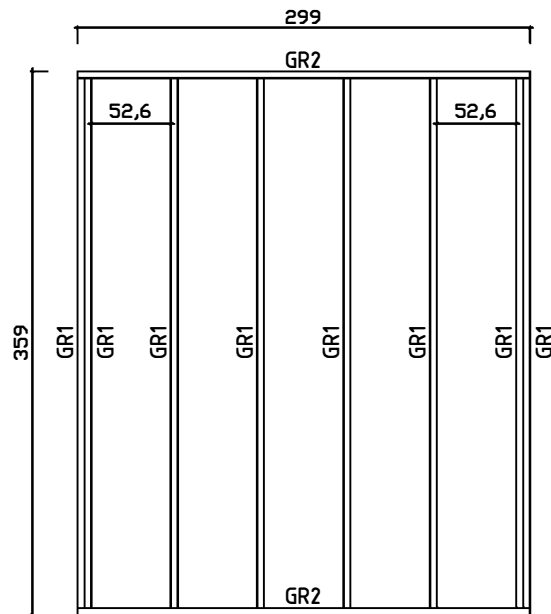









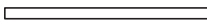

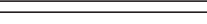

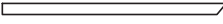

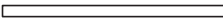





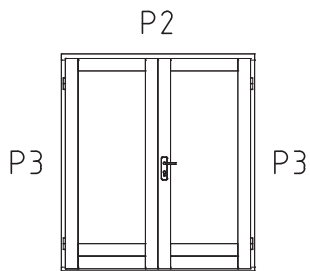
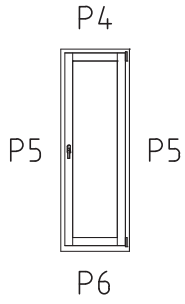

Wir empfehlen als Fundament für Ihr Gartenhaus eine vollflächig festgegründete, gepflasterte oder betonierte Fläche. Wahlweise ist auch ein Punkt- oder Streifenfundament möglich.

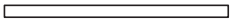

Nr.		Stck.	Profil (mm)	Lenght (mm)
001		2	70x130	3200
002		2	70x130	3200
003		24	70x130	3200
004		2	70x130	3300
005		3	70x128	1072
006		1	70x130	2568
007		2	70x78	1001
008		1	70x130	1766
009		3	70x88	1133
010		1	70x130	2568
011		2	70x130	1766
012		1	70x130	3300
013		1	70x130	2568
014		1	70x78	1001
015		2	70x65	1101
016		2	70x130	1101
017		28	70x130	270
018		28	70x130	221
019		2	70x130	270
020		1	70x130	2817
021		1	70x130	3798
022		1	70x99	3765
023		1	70x99	3035
024		1	70x65	3800
025		1	70x130	3800

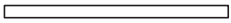
Nr.		Stck	(mm)	Lenght (mm)
026		13	70x130	3800
027		1	70x130	3337
028		1	70x130	3478
029		1	70x130	3765
030		1	70x130	3035
GR1	GROUNDFRAME 	8	45x90	3500
GR2	GROUNDFRAME 	2	45x90	2990
PR1	Purlins 	2	70x170	6800
	WINDOW 600x1770	2		
	DOOR 1588x1965	1		
1	Screws/Schrauben/Vis 5x100 mm- For fixing first row of wall logs /Fixierung des ersten Bohlenkranzes/Pour fixer les lames de plancher		6	
2	Nails/Nägel/Clous 2.5x50 - For fixing floorboards/ Befestigung Fussbodenbretter/Pour fixer les lames de plancher		250	
3	Nails/Nägel/Clous 2.5x50 - For fixing roofboards/ Befestigung Dachbretter/Pour fixer les voliges		400	
4	Nails/Nägel/Clous 2.5x50 - For fixing floor edge trims/ Befestigung Fussleisten/Pour fixer les plinthes du plancher		30	
5	Nails/Nägel/Clous 2.5x50 - For fixing roofing felt fillet/ Befestigung giebelabschlussbrett/Pour fixer la latte de finition de la couverture		30	
6	Screws/Schrauben/Vis 2,5x50 mm- For fixing roof side boards and roof edge reinforcement Befestigung Traufenbretter und Traufenleisten Pour fixer les planches de rive et le tasseau de refront		175	
7	Screws/Schrauben/Vis 2,5x50 mm- For fixing fascia boards and diamonds/ Befestigung Giebelblende und Raute Pour fixer les planches de rive et le diamant			
8	Screws/Schrauben/Vis 2,5x50 mm- For fixing fwindow and door trims/ Befestigung Fenster und türen/ Pour fixer les croisillons des fenetres et des portes			
9	Metal storm Brace/Gewindestange/Tige filetee 8 mm 	3		
10	Shim/Nuts/Mutter ,U-Scheibe/Ecrou/Rondelle 8 mm For fixing storm braces/ Pour fixer les anti tempete/ Für Sturmleisten Pour fixer les croisillons des fenetres et des portes Metal storm Brace/Gewindestange/Tige filetee 8 mm KL1 M8 2,12 m 1 Screws 180 6 pcs. KL2 M8 2,25 m 2 Plastic caps 3 pcs.		3/3	
11	Roofing felt/Dachpappe/Feutre de toiture		10+10+15	
12	Nails/Nägel/Clous - For fixing roofing felt/ Befestigung Dachpappe/Pour fixer les feutre de toiture		270	
13	Screws/Schrauben/Vis 4.5x70 mm PR1 		8	
14	Screws/Schrauben/Vis 6x180 mm 		4	

POS	ST.	B	H	L	Teileliste	
GR1	Vt. spetsi					FUNDMENTHOLZER
F1	9,9m ²	28		2855		FUSSBODENBRETTER
PR	2	70	170	6800		DACHBALKEN
RB1	26,6m ²	20		3912		DACHBRETTER
R1	4	20	140	3420		Traufenbretter 
R2	4	45	65	3400		Traufenbretter 
R3	2	20	140	4120		Giebelabschlussleiste 
R4	2	20	90	4120		Giebelabschlussleiste 
DP			10+10+15		DACHPAPPE + NÄGEL (270)	
SK	2	70	65			SCHLAGKLOTZ 
PS	2	90 120	90 120	1900		PFOSTEN 
SL	4	30	30	1720		SLIDING SLATS 
DR1	1	1588	1965			
WN1	2	600	1770			
P1	14m	20	40			Fußbodenleiste
P2	1+1	20	90	1890		Türleiste DR1 
P3	2+2	20	90	1945		Türleiste DR1 
P4	2+2	20	90	900		Fensterleiste WN1 
P5	4+4	20	90	1920		Fensterleiste WN1 
P6	2+2	20	90	540 570		Fensterleiste WN1 