

# Technische Daten: Art.-Nr.: 871 754 mit Seitendach 400 cm rechts

Wandaußenmaß: 740 x 360 cm

Bohlenstärke: 70 mm



Der Fußboden wurde bauseits vom Kunden ergänzt.

Kontrolliert durch:

Achtung: Alle angegebenen Maße sind ca.-Maße!

# Grundriss

## 871 754 mit Seitendach 400 cm rechts

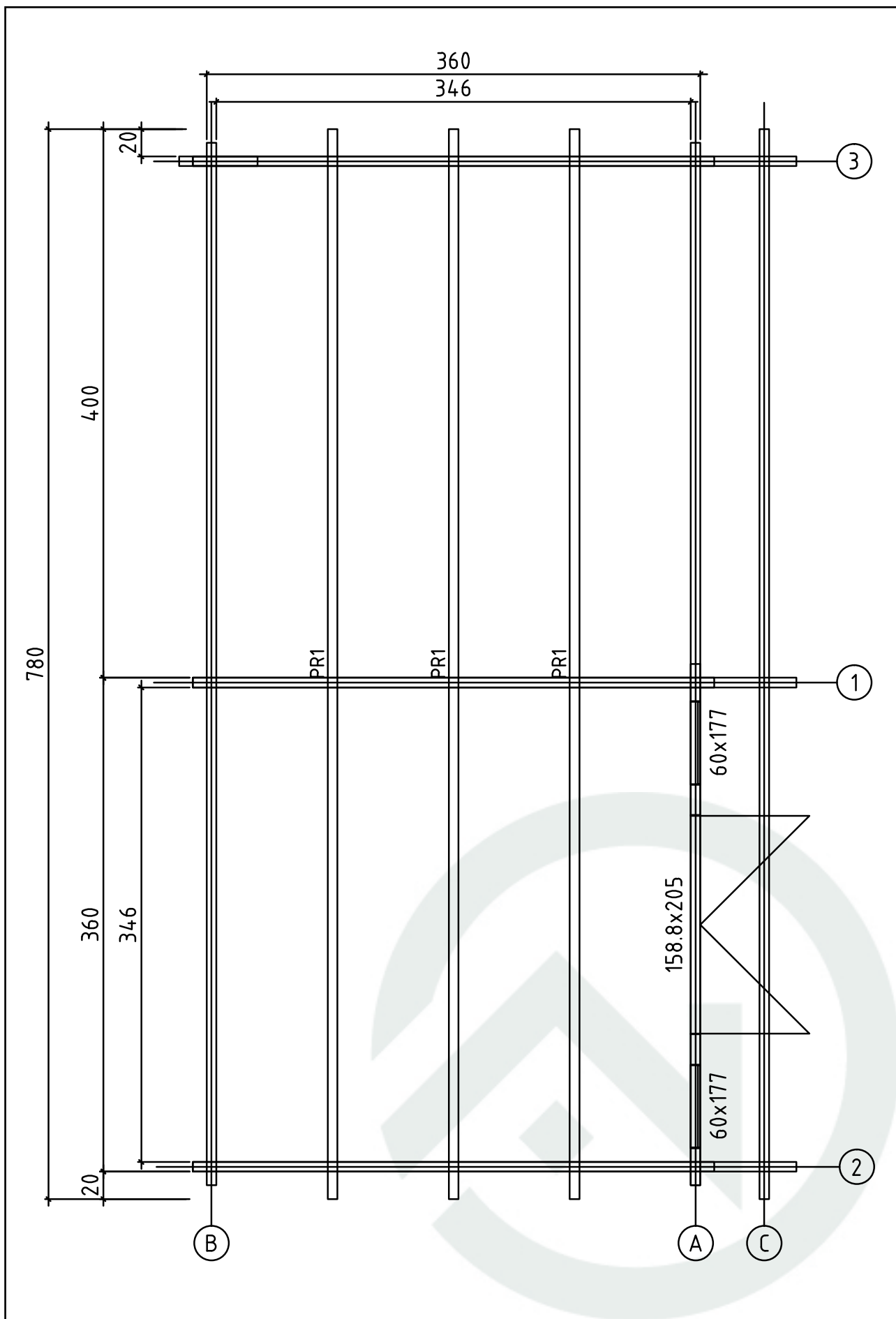





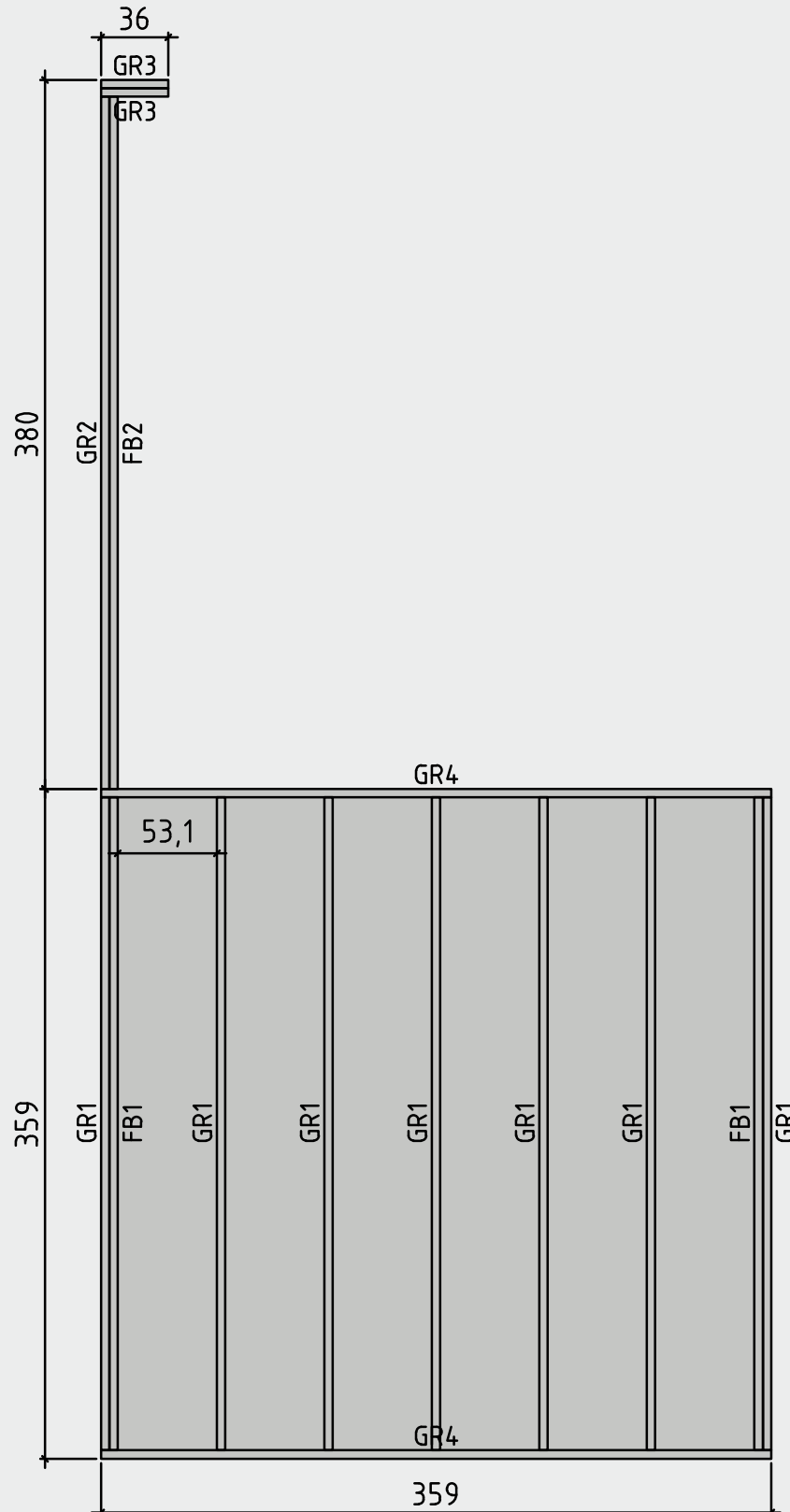



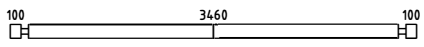
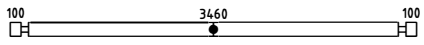
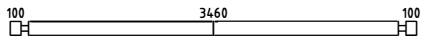
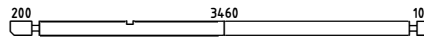
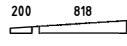

# Lagerholzplan und Fundamentplan 871 754 mit Seitendach 400 cm rechts

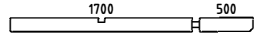
Wir empfehlen als Fundament für Ihr Gartenhaus eine vollflächig festgegründete, gepflasterte oder betonierte Fläche.  
Wahlweise ist auch ein Punkt- oder Streifenfundament möglich.

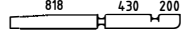
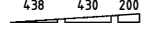

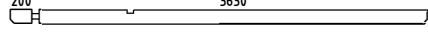
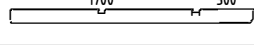

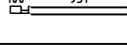
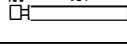
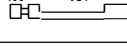
# Teileliste 1

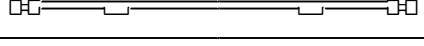
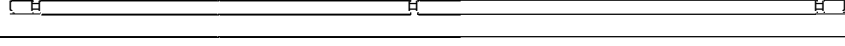
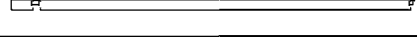
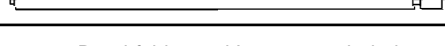
## 871 754 mit Seitendach 400 cm rechts

Pos			Profil (mm)	Lenght (mm)
001		2	70x130	3800
002		2	70x130	3800
003		26	70x130	3800
004		2	70x130	3900
005		3	70x118	1088
006		3	70x130	823
007		2	70x130	2270
008		3	70x45	693
009		2	70x102	852
010		3	70x130	1588
011		3	70x78	1208
012		1	70x130	470
013		14	70x130	470
014		1	70x130	3900
015		1	70x130	2270
016		1	70x102	852
017		2	70x65	1101
018		2	70x130	1101
019		2	70x130	1101
020		26	70x130	270
021		26	70x130	221
022		1	70x130	3800
023		1	70x130	7800
024		1	70x98	3765
025		1	70x98	4035



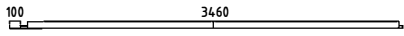
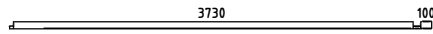
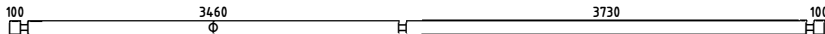
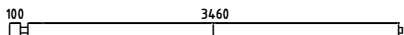
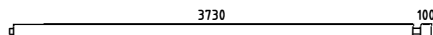
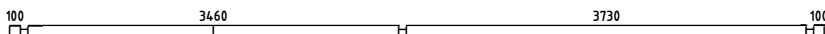
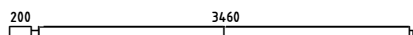
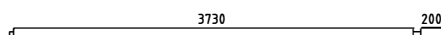
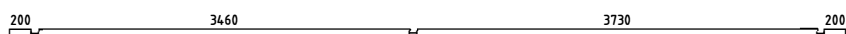
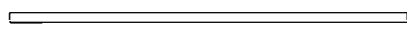
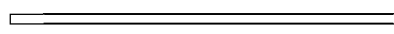
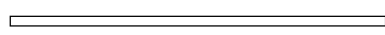

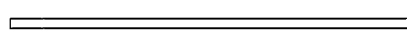
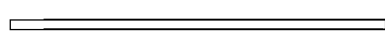
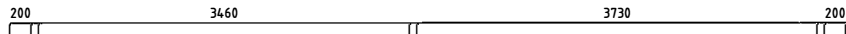





# Teilleiste 2

## 871 754 mit Seitendach 400 cm rechts

Pos			Profil (mm)	Lenght (mm)
026		1	70x65	3665
027		1	70x65	3935
028		1	70x130	7600
029		7	70x130	3665
030		7	70x130	3935
031		7	70x130	7600
032		1	70x130	3765
033		1	70x130	4035
034		1	70x130	7800
035	↓	2	70x27	60
036	-	1	70x27	60
GR2	GROUNDFRAME 	1	45x90	3710
GR4	GROUNDFRAME 	2	45x90	3590
GR1	GROUNDFRAME 	7	45x90	3500
GR3	GROUNDFRAME 	2	45x90	360
FB2	FLOORBEAMS 	1	45x90	3710
FB1	FLOORBEAMS 	2	45x90	3500
PR1	Purlins 	3	70x170	7800
	WINDOW 600x1770	2		
	DOOR 1588x2050	1		

# Teilleiste 3

## 871 754 mit Seitendach 400 cm rechts

1	Screws/Schrauben/Vis 5x100 mm- For fixing first row of wall logs /Fixierung des ersten Bohlenkranzes/Pour fixer les lamesde plancher		6		
2	Nails/Nägél/Clous 2.5x50 - For fixing floorboards/ Befestigung Fussbodenbretter/Pour fixer les lames de plancher		300		
3	Nails/Nägél/Clous 2.5x50 - For fixing roofboards/ Befestigung Dachbretter/Pour fixer les voliges		550		
4	Nails/Nägél/Clous 2.5x50 - For fixing floor edge trims/ Befestigung Fussleisten/Pour fixer les plinthes du plancher		40		
5	Nails/Nägél/Clous 2.5x50 - For fixing roofing felt fillet/ Befestigung giebelabschlussbrett/Pour fixer la latte de finition de la couverture		40		
6	Screws/Schrauben/Vis 2,5x50 mm- For fixing roof side boards and roof edge reinforcement Befestigung Traufenbretter und Traufenleisten Pour fixer les planches de rive et le tasseau de refront		200		
7	Screws/Schrauben/Vis 2,5x50 mm- For fixing fascia boards and diamonds/ Befestigung Giebelblende und Raute Pour fixer les planches de rive et le diamant				
8	Screws/Schrauben/Vis 2,5x50 mm- For fixing fwindow and door trims/ Befestigung Fenster und Türen/ Pour fixer les croisillons des fenestres et des portes				
9	Metal storm Brace/Gewindestange/Tige filetee 10 mm		3		
10	Shim/Nuts/Mutter U-Scheibe/Ecrou/Rondelle 10 mm For fixing storm braces/ Pour fixer les anti tempete/ Für Sturmleisten Pour fixer les croisillons des fenestres et des portes  Metal storm Brace/Gewindestange/Tige filetee 10 mm KL1 M10 2,44 m 2 Screws 180 6 pcs. KL2 M10 2,25 m 1 Plastic caps 3 pcs.		3/3		

# Teileliste 4

## 871 754 mit Seitendach 400 cm rechts

POS	ST.	B	H	L	Teileliste
FB1	Vt. spetsi				FUNDMENTHOLZER
F1	12m <sup>2</sup>	28		3455	FUSSBODENBRETTER
PR	3	70	170	7800	DACHBALKEN
RB1	35,2m <sup>2</sup>	20		4510	DACHBRETTER
R1	4	20	140	3920	<small>Vesta kafise kalcanirka</small> Traufenbretter
R2	4	45	65	3900	<small>Vesta kafise kalcanirka</small> Traufenbretter
R3	2	20	140	4710	<small>Vesta kafise kalcanirka</small> Giebelabschlussleiste
R4	2	20	90	4710	Giebelabschlussleiste
PS1	1	120	120	2050	POSTS FOR SIDEROOF
WN06	2	600	1770		<p style="text-align: center;">Sliding slats 30x30x1600 mm - 4 pcs.</p>
DR16	1	1588	2050		
P1	15m	20	40		Fußbodenleiste
P2	4+4	20	90	1920	Fensterleiste WN 06
P3	1+1	20	90	3440	Türleiste DR 16, Fensterleiste WN 06
P4	2+2	20	90	<del>540</del> 570	Fensterleiste WN 06
P5	2+2	20	90	2030	Türleiste DR 16

# Detailzeichnungen

## 871 754 mit Seitendach 400 cm rechts

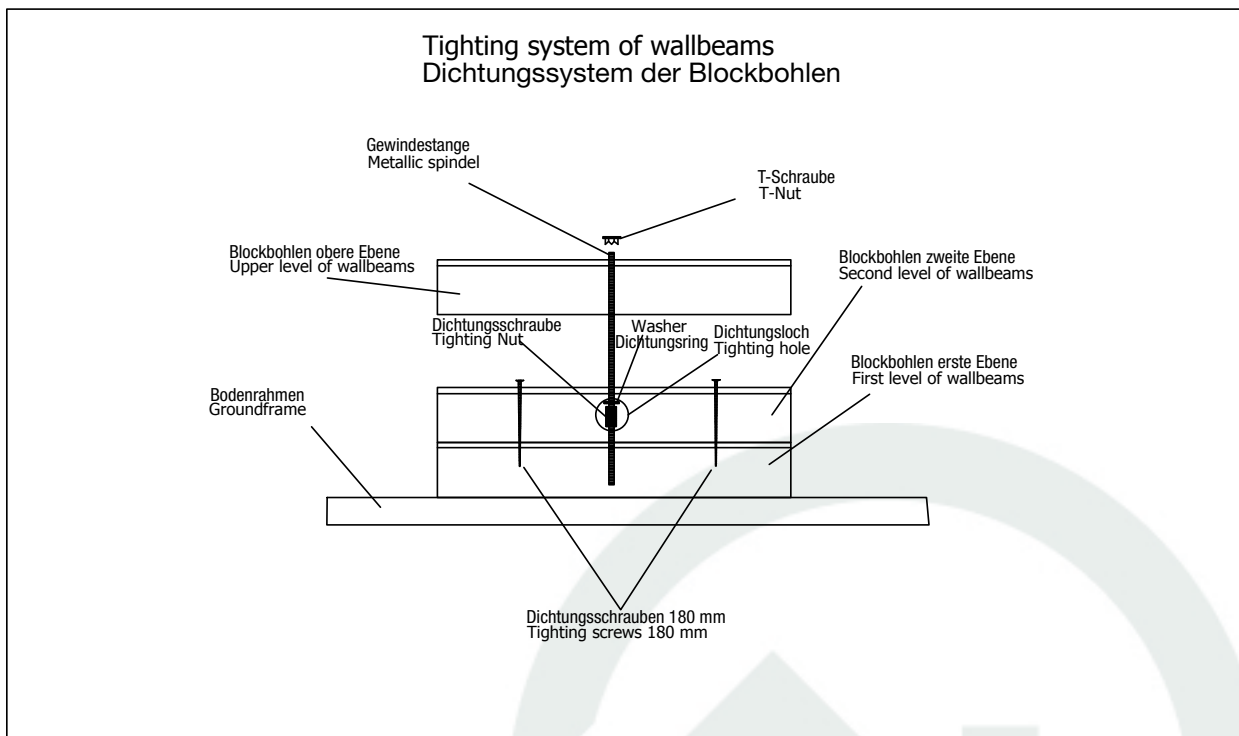
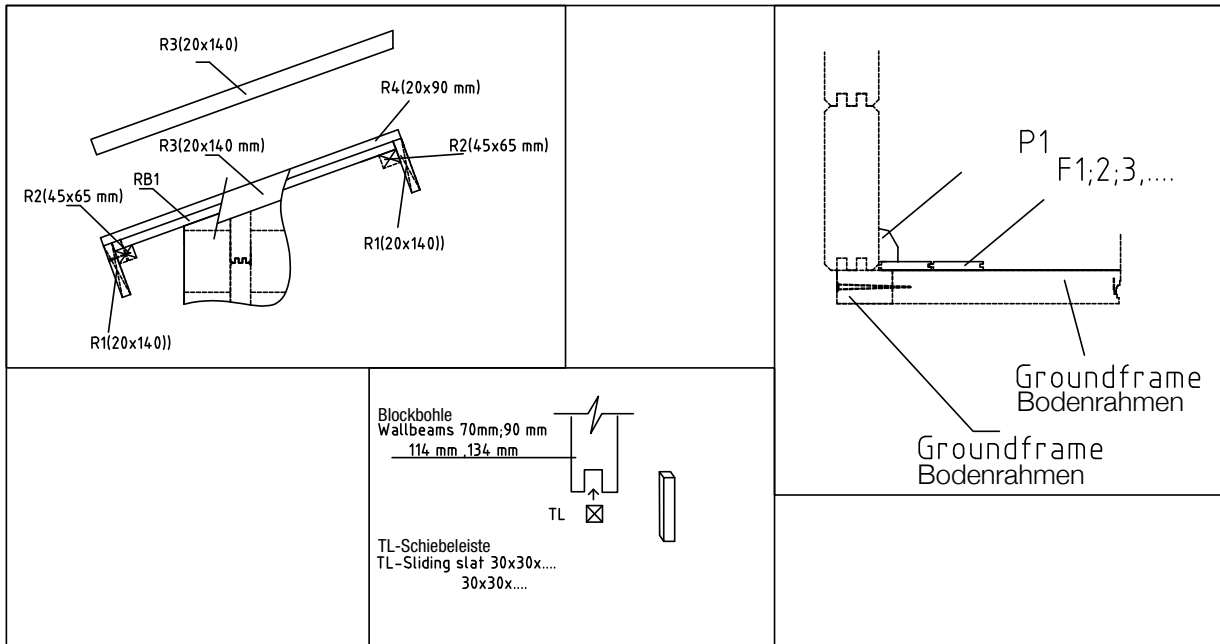



# Wandplan 1 und 2

## 871 754 mit Seitendach 400 cm rechts

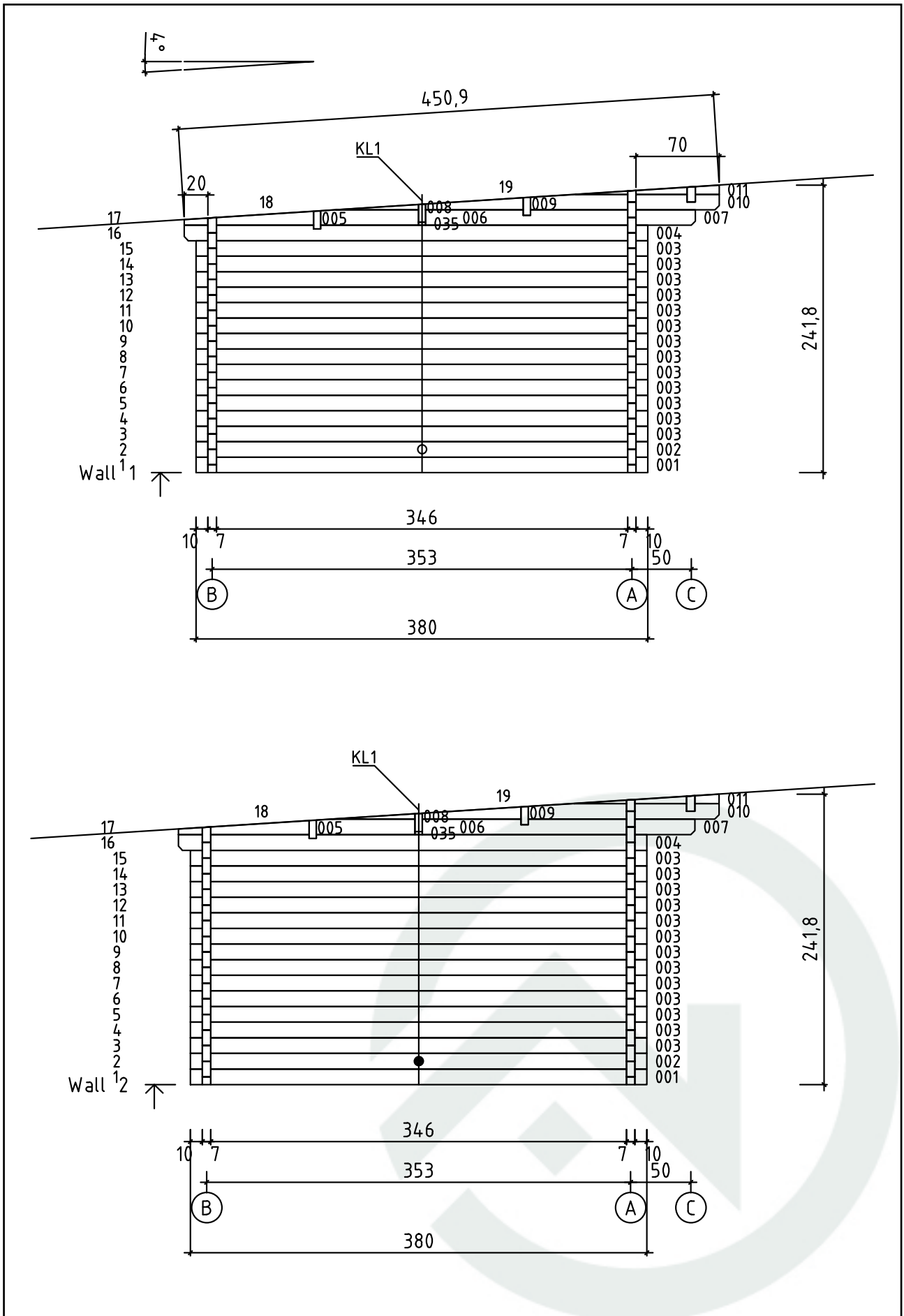

# Wandplan 3

## 871755 mit Seitendach 400 cm rechts

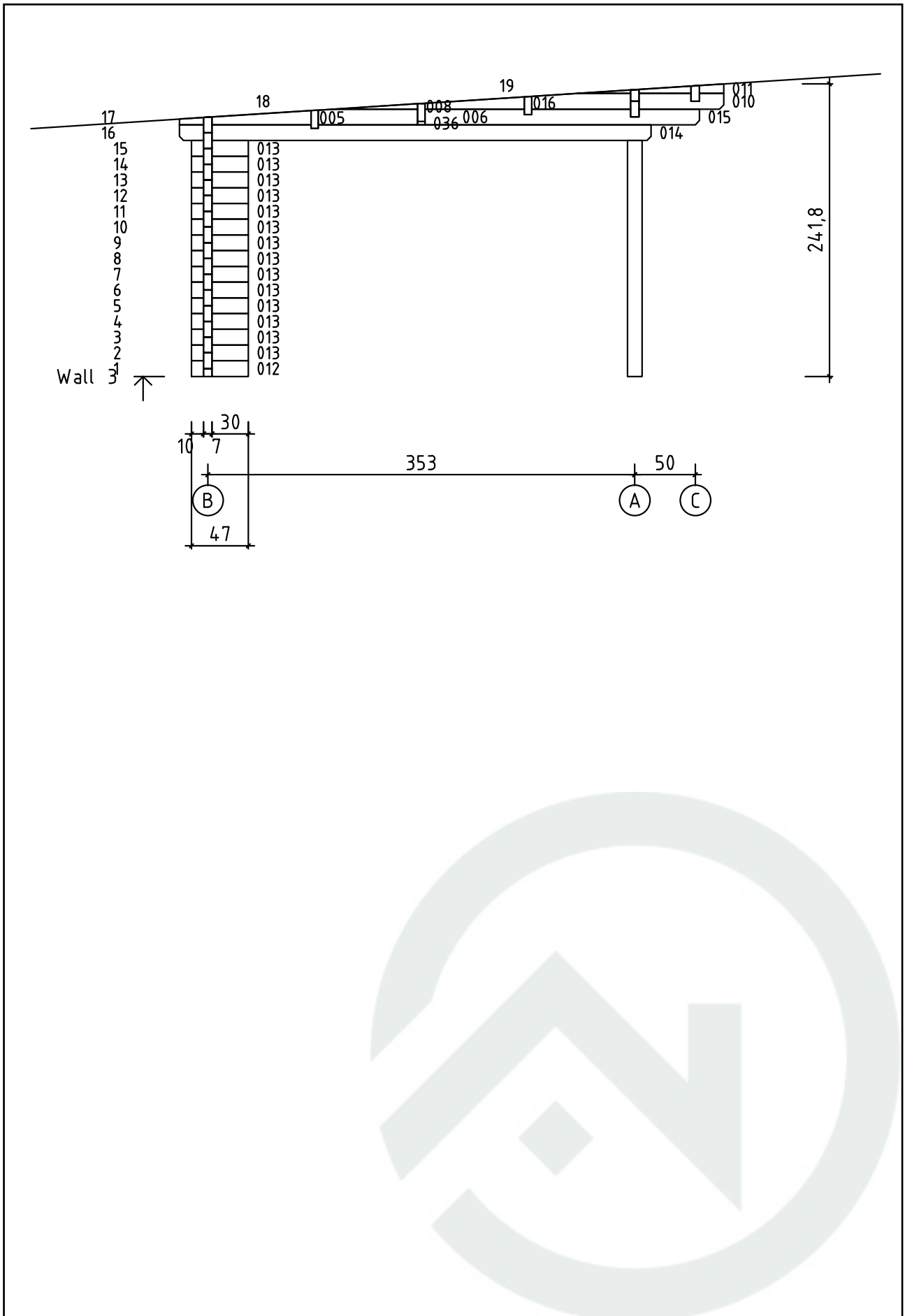

# Wandplan A, B und C

## 871 754 mit Seitendach 400 cm rechts

