

# Technische Daten: Art.-Nr.: 871 714 mit Seitendach 300 cm rechts

Wandaußenmaß: 640 x 300 cm  
Bohlenstärke: 70 mm



871 714 mit Seitendach 300 cm rechts. Der Fußboden wurde bauseits vom Kunden ergänzt.

Kontrolliert durch:

Achtung: Alle angegebenen Maße sind ca.-Maße!

# Grundriss

## 871 714 mit Seitendach 300 cm rechts

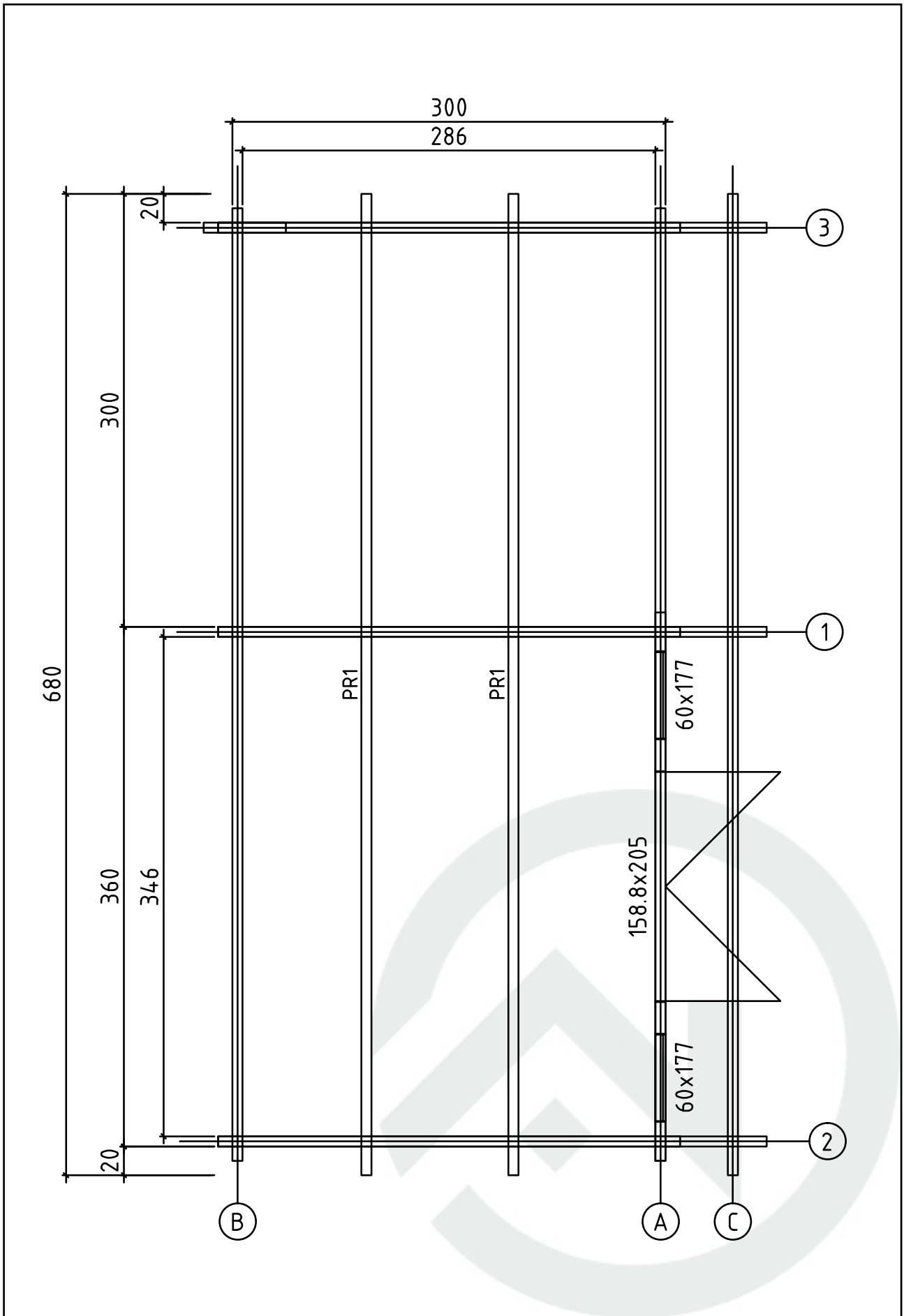









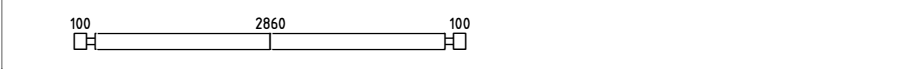
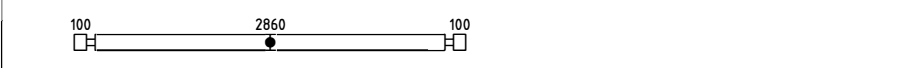
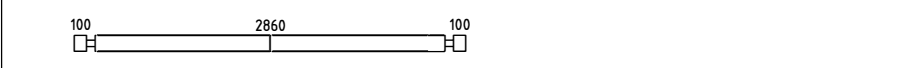
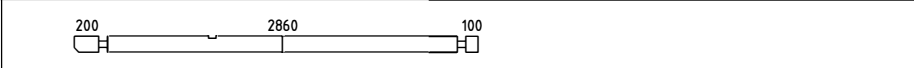

# Lagerholzplan und Fundamentplan 871 714 mit Seitendach 300 cm rechts

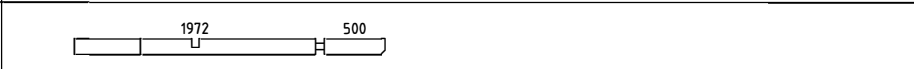
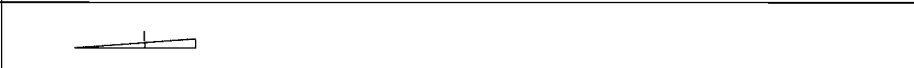
Wir empfehlen als Fundament für Ihr Gartenhaus eine vollflächig festgegründete, gepflasterte oder betonierte Fläche.  
Wahlweise ist auch ein Punkt- oder Streifenfundament möglich.

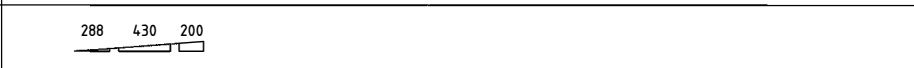
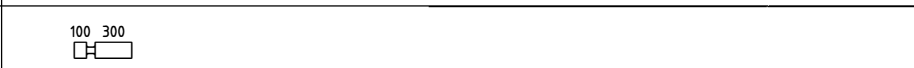

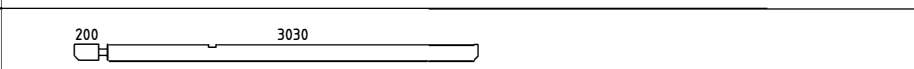
# Teilleiste 1

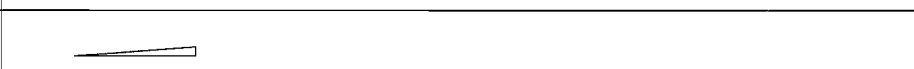
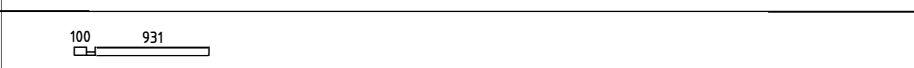
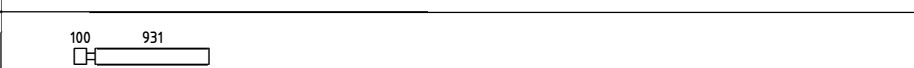
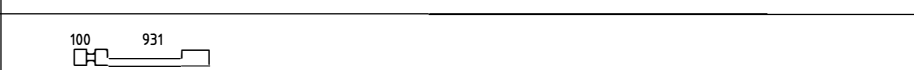
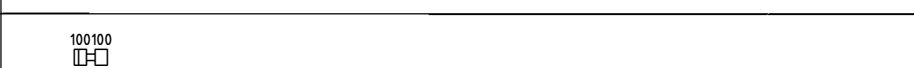
## 871 714 mit Seitendach 300 cm rechts

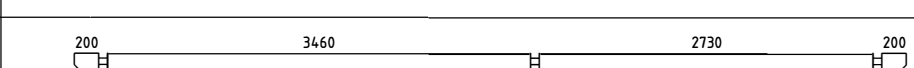
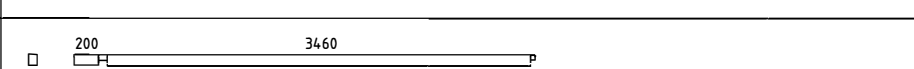
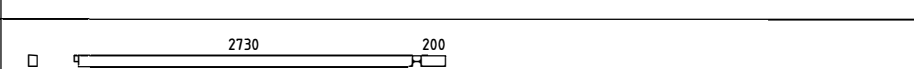
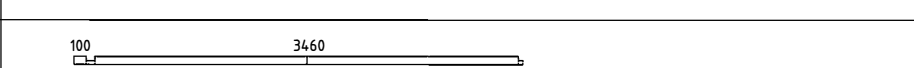
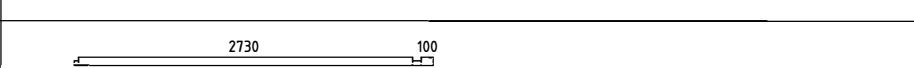
Pos		†	Profil (mm)	Lenght (mm)
001		2	70x130	3200
002		2	70x130	3200
003		26	70x130	3200
004		2	70x130	3300
005		3	70x128	1098
006		2	70x130	2542
007		2	70x75	989
008		3	70x130	1754
009		3	70x80	1058
010		1	70x130	470
011		14	70x130	470
012		1	70x130	3300
013		1	70x130	2542
014		1	70x75	989
015		2	70x65	1101
016		2	70x130	1101
017		2	70x130	1101
018		26	70x130	270
019		26	70x130	221
020		1	70x130	3800
021		1	70x130	6800
022		1	70x92	3765
023		1	70x92	3035
024		1	70x65	3665
025		1	70x65	2935

# Teileliste 2

## 871 714 mit Seitendach 300 cm rechts

Pos		Profil (mm)	Length (mm)
026		70x130	6600
027		70x130	3665
028		70x130	2935
029		70x130	6600
030		70x130	3765
031		70x130	3035
032		70x130	6800
GR1	GROUNDFRAME 	45x90	3500
GR4	GROUNDFRAME 	45x90	2990
GR2	GROUNDFRAME 	45x90	2710
GR3	GROUNDFRAME 	45x90	360
FB1	FLOORBEAMS 	45x90	3500
FB2	FLOORBEAMS 	45x90	2710
PR1	Purlins 	70x170	6800
	WINDOW 600x1770		2
	DOOR 1588x2050		1
1	Screws/Schrauben/Vis 5x100 mm- For fixing first row of wall logs /Fixierung des ersten Bohlenkranzes/Pour fixer les lamesde plancher		6
2	Nails/Nägél/Clous 2.5x50 - For fixing floorboards/ Befestigung Fussbodenbretter/Pour fixer les lames de plancher		250
3	Nails/Nägél/Clous 2.5x50 - For fixing roofboards/ Befestigung Dachbretter/Pour fixer les voliges		400
4	Nails/Nägél/Clous 2.5x50 - For fixing floor edge trims/ Befestigung Fussleisten/Pour fixer les plinthes du plancher		30
5	Nails/Nägél/Clous 2.5x50 - For fixing roofing felt fillet/ Befestigung giebelabschlussbrett/Pour fixer la latte de finition de la couverture		30
6	Screws/Schrauben/Vis 2,5x50 mm- For fixing roof side boards and roof edge reinforcement Befestigung Traufenbretter und Traufenleisten Pour fixer les planches de rive et le tasseau de refront		175
7	Screws/Schrauben/Vis 2,5x50 mm- For fixing fascia boards and diamonds/ Befestigung Giebelblende und Raute Pour fixer les planches de rive et le diamant		
8	Screws/Schrauben/Vis 2,5x50 mm- For fixing fwindow and door trims/ Befestigung Fenster und Türen/ Pour fixer les croisillons des fenestres et des portes		
9	Metal storm Brace/Gewindestange/Tige filetee 10 mm		3
10	Shim,Nuts/Mutter ,U-Scheibe/Ecrou/Rondelle 10 mm For fixing storm braces/ Pour fixer les anti tempete/ Für Sturmleisten Pour fixer les croisillons des fenestres et des portes Metal storm Brace/Gewindestange/Tige filetee 10 mm KL1 M10 2,44 m 2 Screws 180 6 pcs. KL2 M10 2,25 m 1 Plastic caps 3 pcs.		3/3

# Teileliste 3

## 871 714 mit Seitendach 300 cm rechts

POS	ST.	B	H	L	Teileliste
FB1	Vt. spetsi				FUNDMENTHOLZER
F1	9,9m <sup>2</sup>	28		2855	FUSSBODENBRETTER
PR	2	70	170	6800	DACHBALKEN
RB1	26,6m <sup>2</sup>	20		3911	DACHBRETTER
R1	4	20	140	3420	<small>Vaata kotise kaltem rka</small> Traufenbretter
R2	4	45	65	3400	<small>Vaata kotise kaltem rka</small> Traufenbretter
R3	2	20	140	4120	<small>Vaata kotise kaltem rka</small> Giebelabschlussleiste
R4	2	20	90	4120	Giebelabschlussleiste
PS1	1	120	120	2050	POSTS FOR SIDEROOF
WN06	2	600	1770		<p style="text-align: center;">Sliding slats 30x30x1600 mm - 4 pcs.</p>
DR16	1	1588	2050		
P1	14 m	20	40		Fußbodenleiste
P2	4+4	20	90	1920	Fensterleiste WN 06
P3	1+1	20	90	3440	Türleiste DR 16, Fensterleiste WN 06
P4	2+2	20	90	<del>540</del> 570	Fensterleiste WN 06
P5	2+2	20	90	2030	Türleiste DR 16

# Detailzeichnungen

## 871 714 mit Seitendach 300 cm rechts

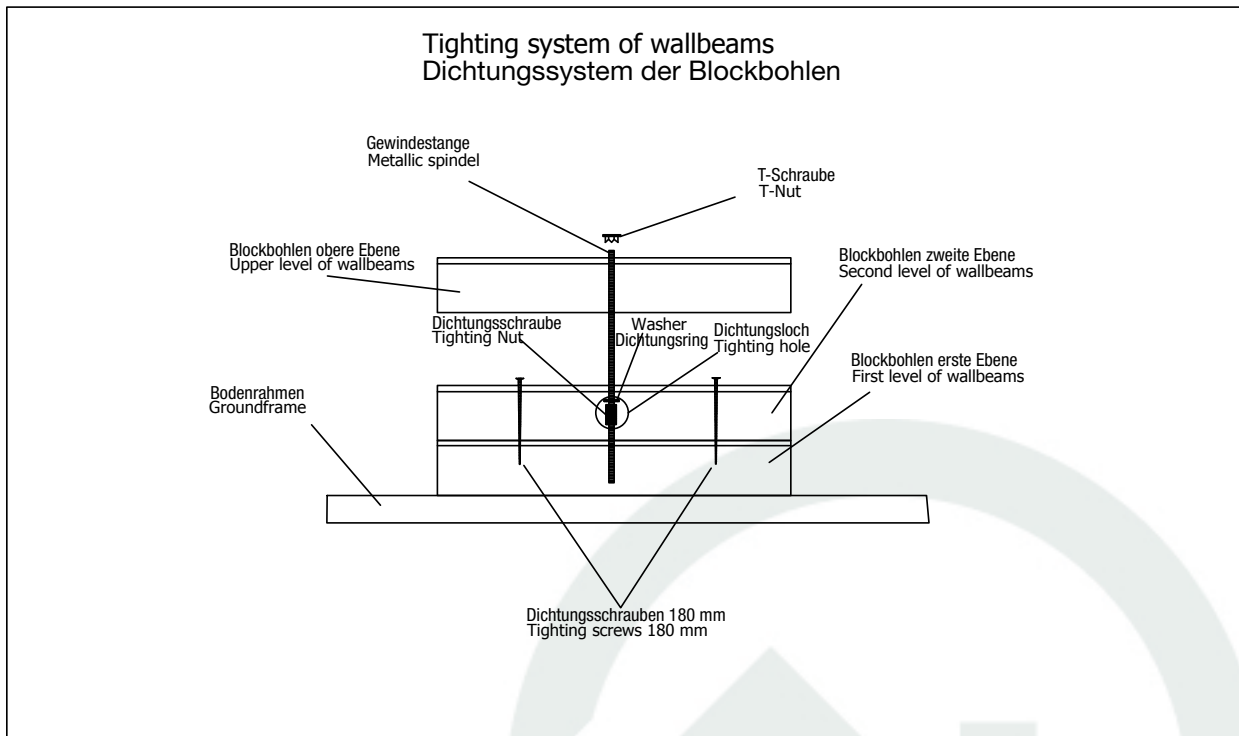
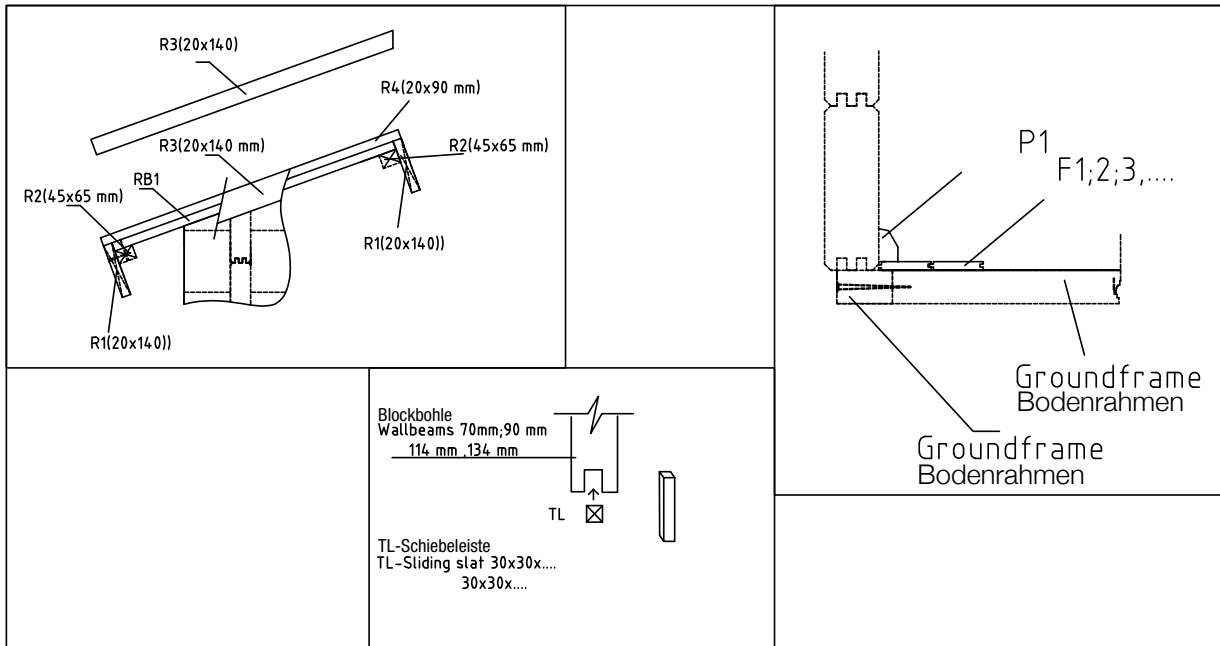

# Wandplan 1 und 2

## 871 714 mit Seitendach 300 cm rechts

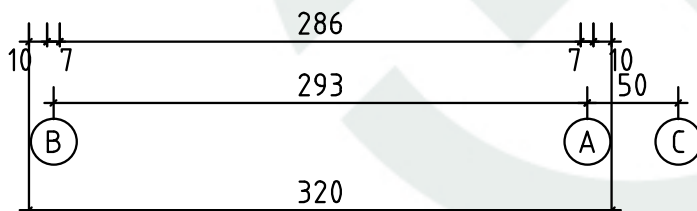
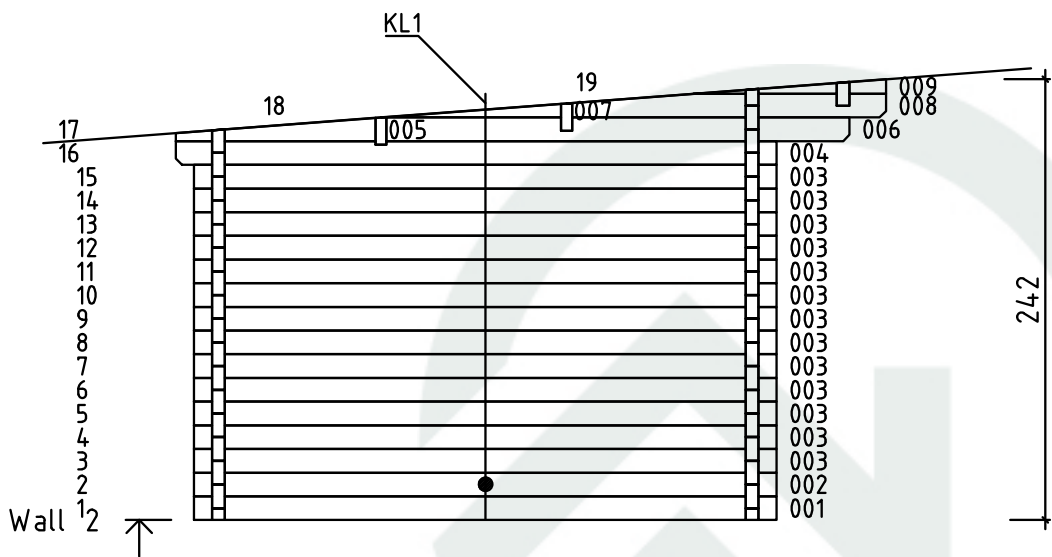
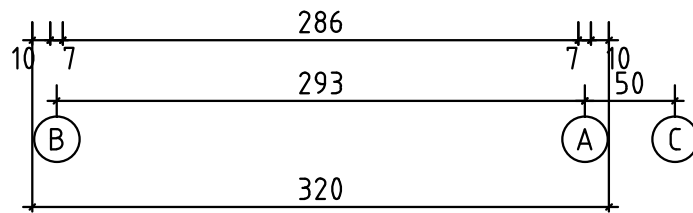
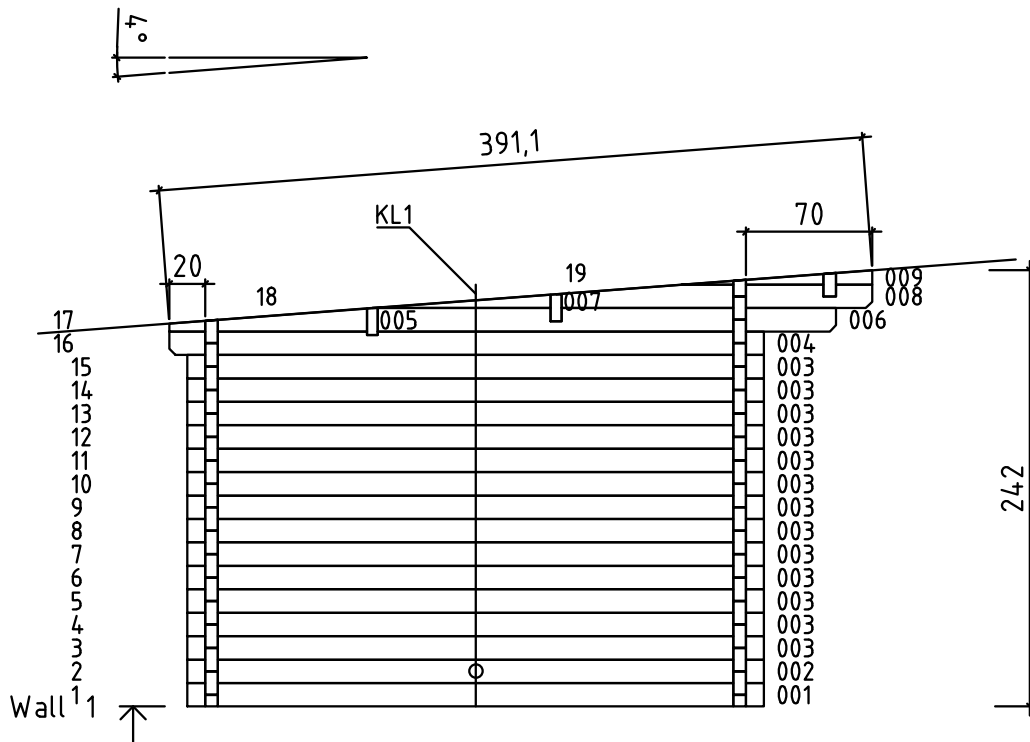



# Wandplan 3

## 871 714 mit Seitendach 300 cm rechts

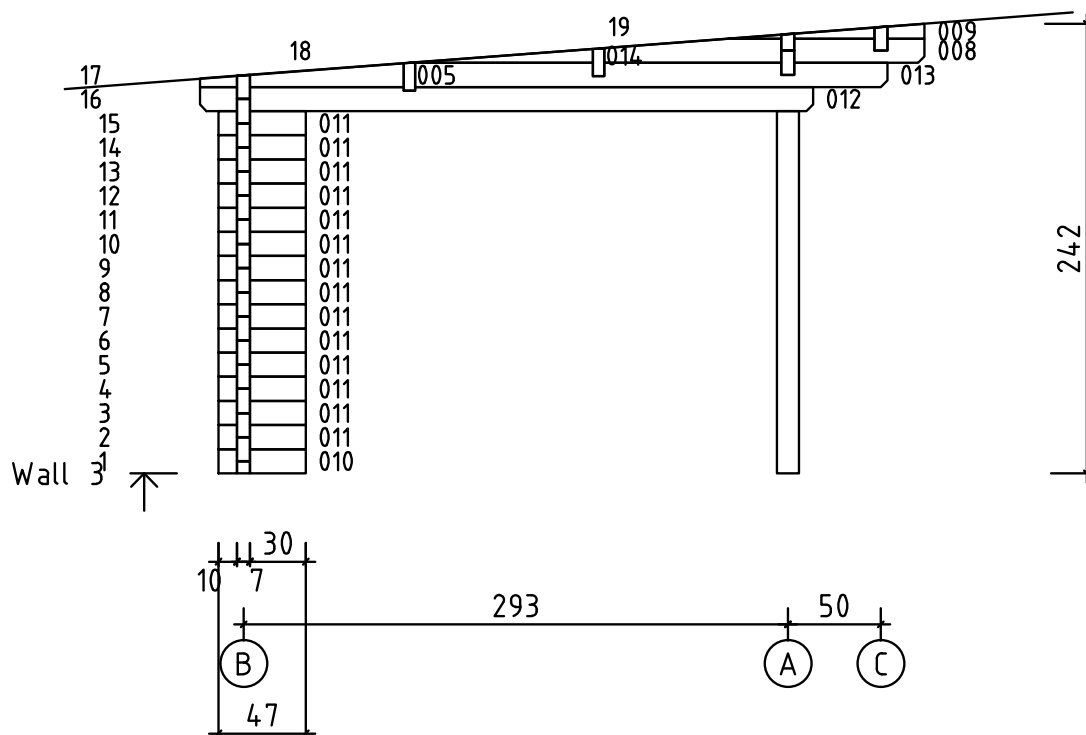

# Wandplan A, B und C

## 871 714 mit Seitendach 300 cm rechts

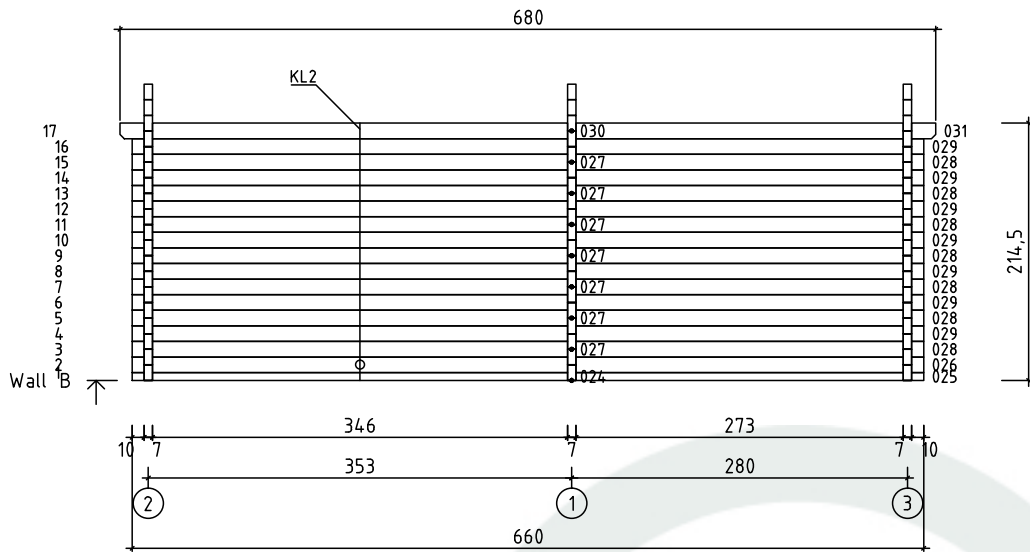
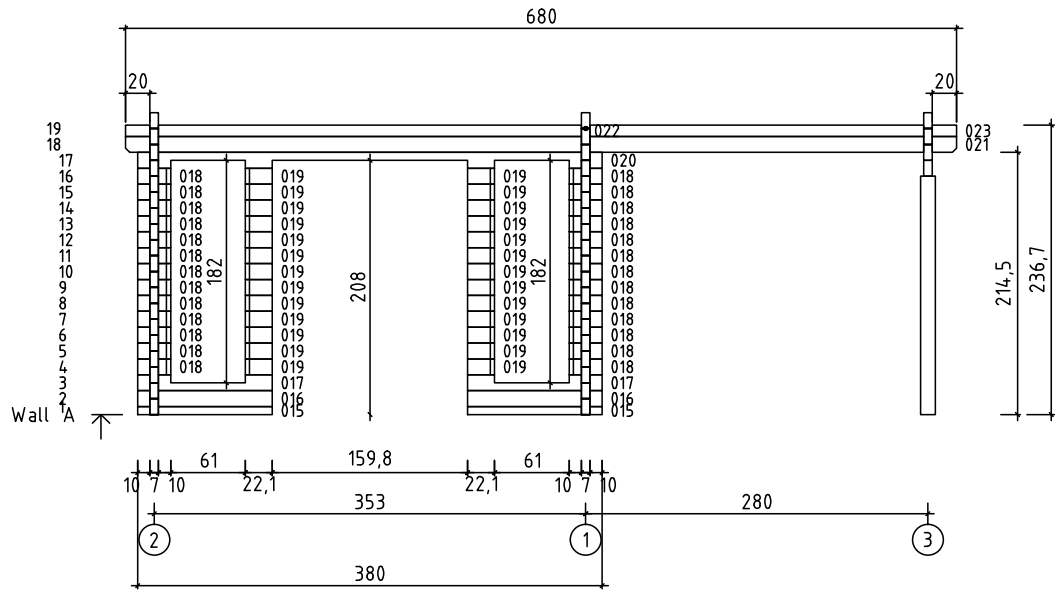

### Vorgelagerte Vordachbohle vor Wand A

