

**Technische Daten: Art.-Nr.: 870965**

**Wandaußenmaß: 530 x 530 cm**

**Bohlenstärke: 70 mm**



Trondheim 70-D XL

Kontrolliert durch:

Empty box for signature or name.

Achtung: Alle angegebenen Maße sind ca.-Maße!

# 3D-Darstellung und Grundriss 870965

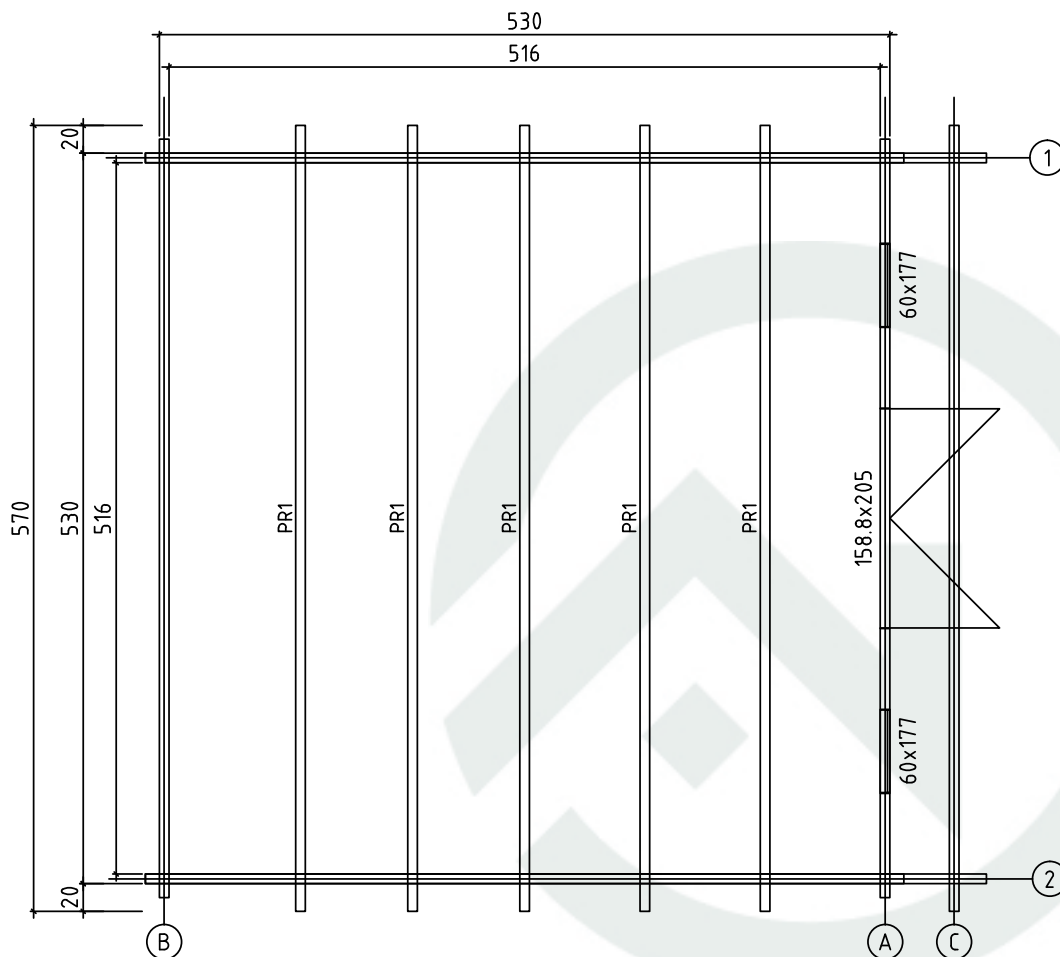
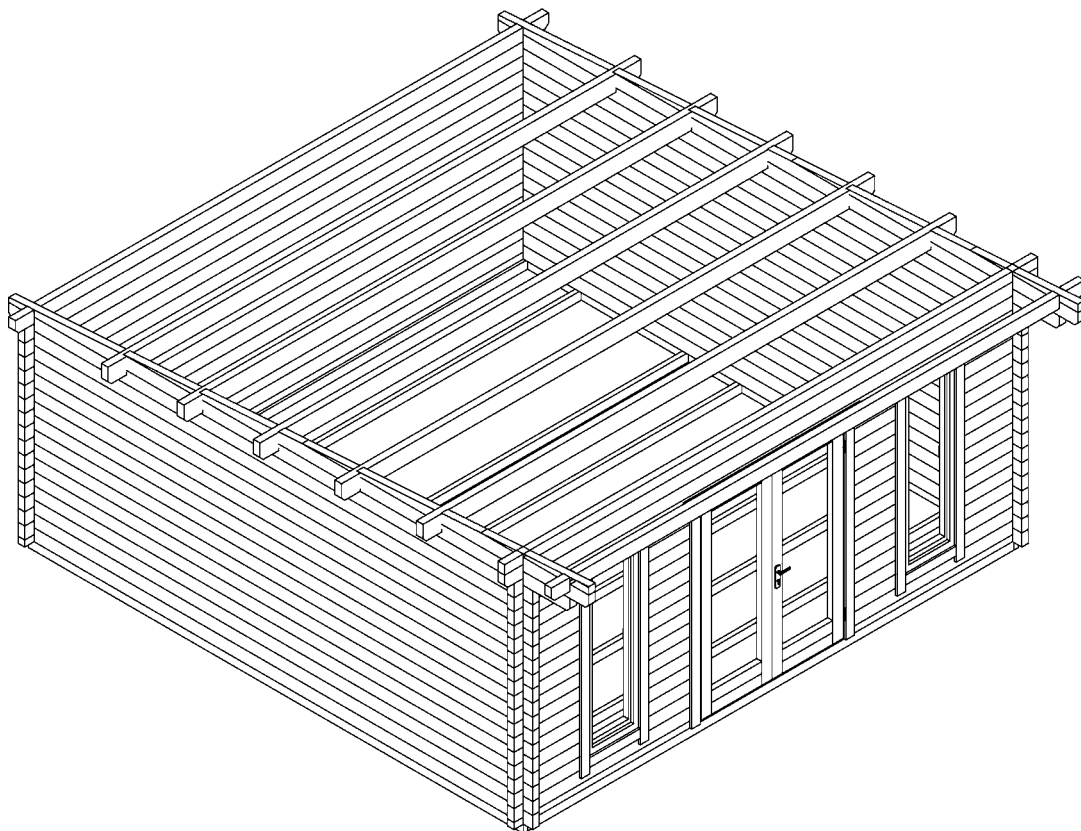





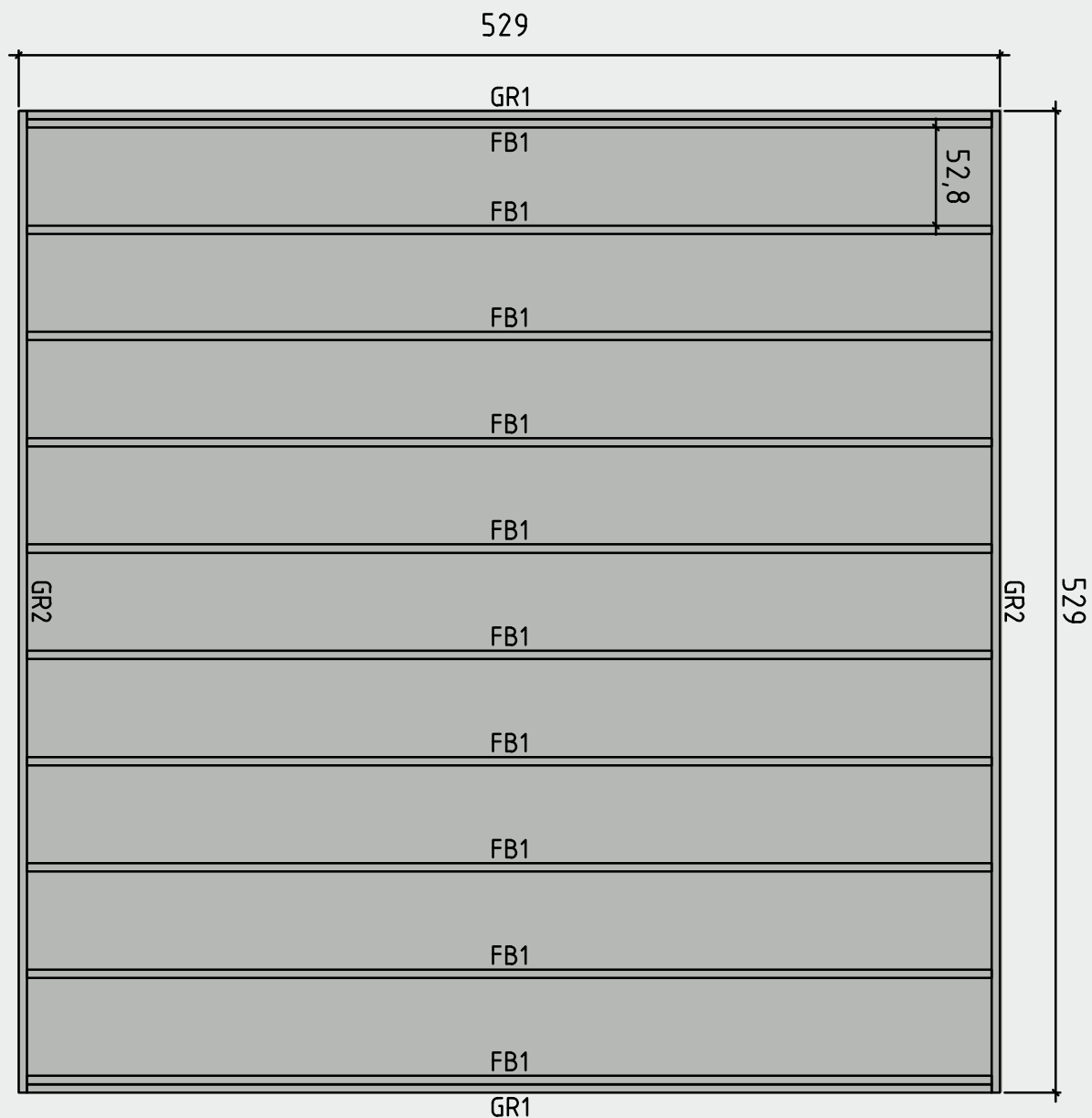

# Lagerholzplan und Fundamentplan 870965

Wir empfehlen als Fundament für Ihr Gartenhaus eine vollflächig,  
festgegründete gepflasterte oder betonierte Fläche.  
Wahlweise ist auch ein Punkt- oder Streifenfundament möglich.

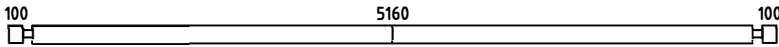
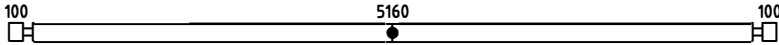
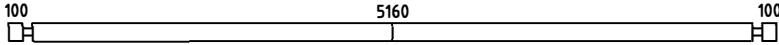
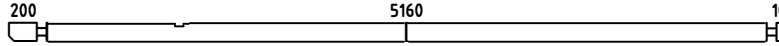
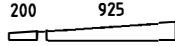
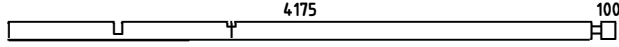

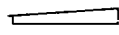
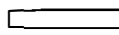
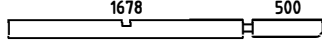
# Teileliste 1

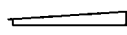
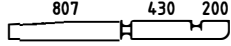
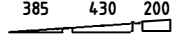
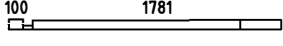
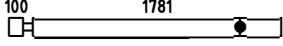
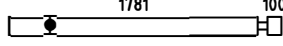
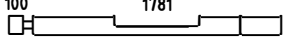
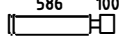
## 870965

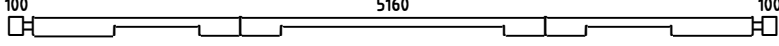
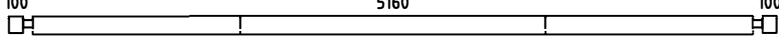
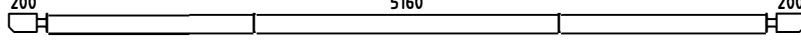
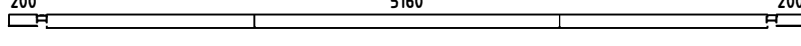
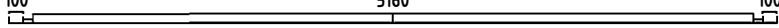
Pos			Profil (mm)	Lenght (mm)
001		2	70x130	5500
002		3	70x130	5500
003		40	70x130	5500
004		2	70x130	5600
005		2	70x128	1195
006		2	70x130	4345
007		2	70x53	782
008		2	70x109	782
009		2	70x130	812
010		2	70x130	2248
011		2	70x38	557
012		2	70x97	842
013		2	70x130	1577
014		2	70x79	1155
015		2	70x65	1951
016		1	70x130	1951
017		1	70x130	1951
018		2	70x130	1951
019		26	70x130	756
020		26	70x130	586
021		1	70x130	5500
022		1	70x130	5500
023		1	70x130	5700
024		1	70x96	5700
025		1	70x65	5500

# Teilleiste 2

## 870965

Pos			Profil (mm)	Lenght (mm)
026		1	70x130	5700
027		1	70x130	5700
GR2	GROUNDFRAME 	2	45x90	5290
GR1	GROUNDFRAME 	2	45x90	5200
FB1	FLOORBEAMS 	10	45x90	5200
PR1	Purlins 5160 	5	70x170	5700
70mm A-5	WINDOW 600x1770	2		
Wolff 70 mm Double Door 1 H	DOOR 1588x2050	1		
1	Screws/Schrauben/Vis 5x100 mm- For fixing first row of wall logs /Fixierung des ersten Bohlenkranzes/Pour fixer les lamesde plancher	6		
2	Nails/Nägel/Clous 2.5x50 - For fixing floorboards/ Befestigung Fussbodenbretter/Pour fixer les lames de plancher	575		
3	Nails/Nägel/Clous 2.5x50 - For fixing roofboards/ Befestigung Dachbretter/Pour fixer les voliges	575		
4	Nails/Nägel/Clous 2.5x50 - For fixing floor edge trims/ Befestigung Fussleisten/Pour fixer les plinthes du plancher	40		
5	Nails/Nägel/Clous 2.5x50 - For fixing roofing felt fillet/ Befestigung giebelabschlussbrett/Pour fixer la latte de finition de la couverture	40		
6	Screws/Schrauben/Vis 2,5x50 mm- For fixing roof side boards and roof edge reinforcement Befestigung Traufbretter und Traufleisten Pour fixer les planches de rive et le tasseau de refront	175		
7	Screws/Schrauben/Vis 2,5x50 mm- For fixing fascia boards and diamonds/ Befestigung Giebelblende und Raute Pour fixer les planches de rive et le diamant			
8	Screws/Schrauben/Vis 2,5x50 mm- For fixing fwindow and door trims/ Befestigung Fenster und türen/ Pour fixer les croisillons des fenetres et des portes			
9	Metal storm Brace/Gewindestange/Tige filetee 10 mm	3		
10	Shim,Nuts/Mutter ,U-Scheibe/Ecrou;Rondelle 10 mm For fixing storm braces/ Pour fixer les anti tempete/ Für Sturmleisten Pour fixer les croisillons des fenetres et des portes Metal storm Brace/Gewindestange/Tige filetee 10 mm KL1 M10 2,12 m 1 Screws 180 6 pcs. KL2 M10 2,18 m 2 Plastic caps 3 pcs.	3/3		

# Teileliste 3

## 870965

POS	ST.	B	H	L	Teileliste
FB1	Vt. spetsi				FUNDMENTHOLZER
F1	26,6m <sup>2</sup>	28		5155	FUSSBODENBRETTER
PR	5	70	170	5700	DACHBALKEN
RB1	16,3m <sup>2</sup> 19,2m <sup>2</sup>	20		2857 3358	DACHBRETTER
R1	2	20	140	5740	<small>Vaata katuse kaldeurka</small> Traufenbretter
R2	2	45	65	5700	<small>Vaata katuse kaldeurka</small> Traufenbretter
R3	4	20	140	3210	<small>Vaata katuse kaldeurka</small> Giebelabschlussleiste
R4	4	20	90	3210	Giebelabschlussleiste
WN06	2	600	1770		<p style="margin: 0;">Sliding slats 30x30x1600 mm - 4 pcs.</p>
DR16	1	1588	2050		
P1	22m	20	40		Fußbodenleiste
P2	4+4	20	90	1920	Fensterleiste WN 06
P3	2+2	20	90	900	Fensterleiste WN 06
P4	2+2	20	90	<del>540</del> 570	Fensterleiste WN 06
P5	2+2	20	90	2030	Türleiste DR 16
P6	1+1	20	90	1890	Türleiste DR 16

# Detailzeichnungen 870965

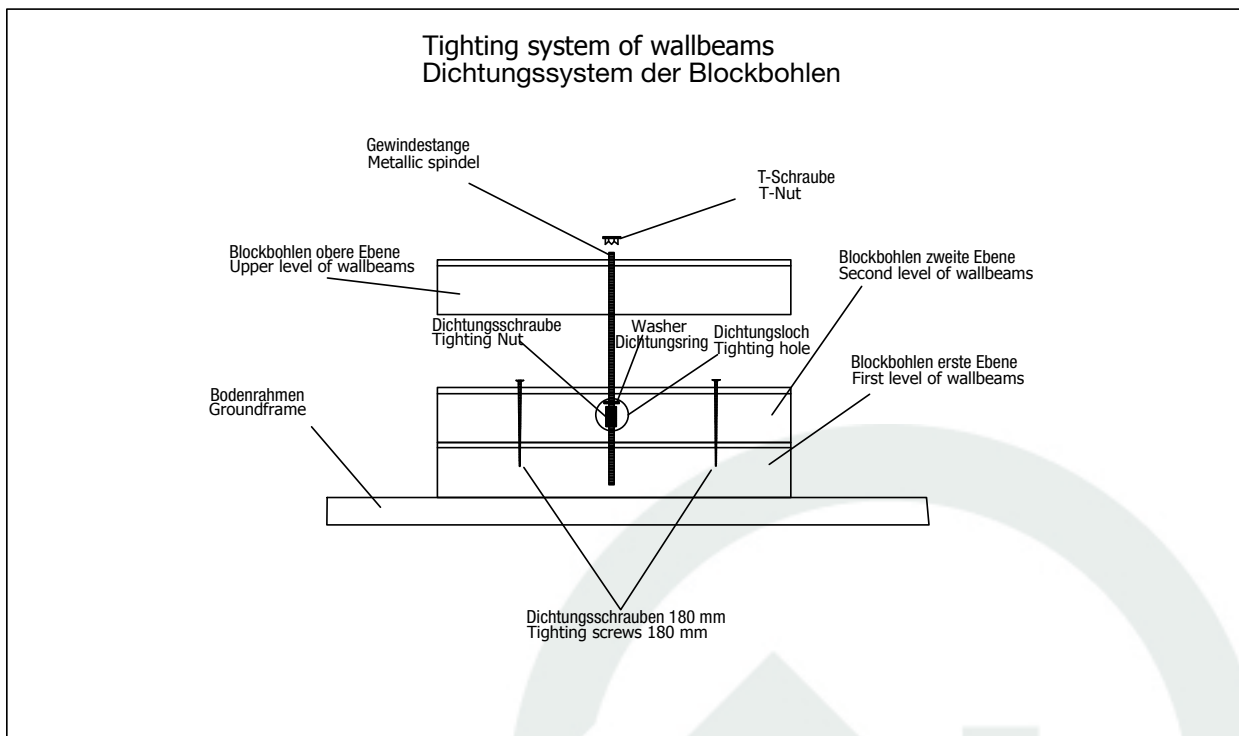
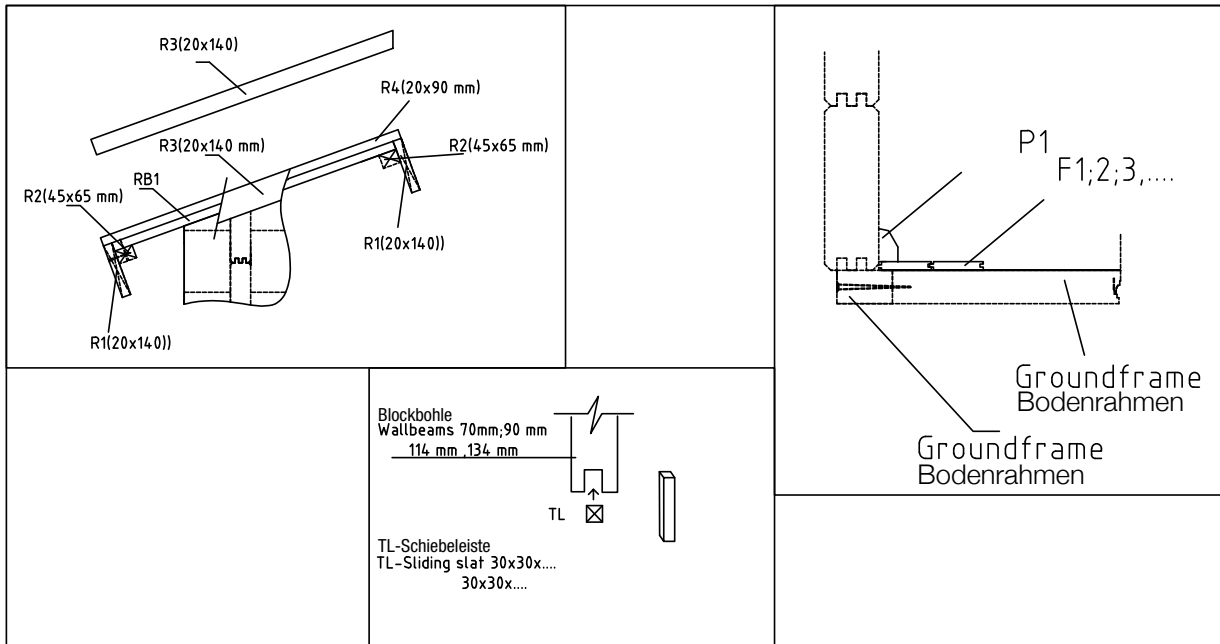

# Wandplan 1 und 2 870965

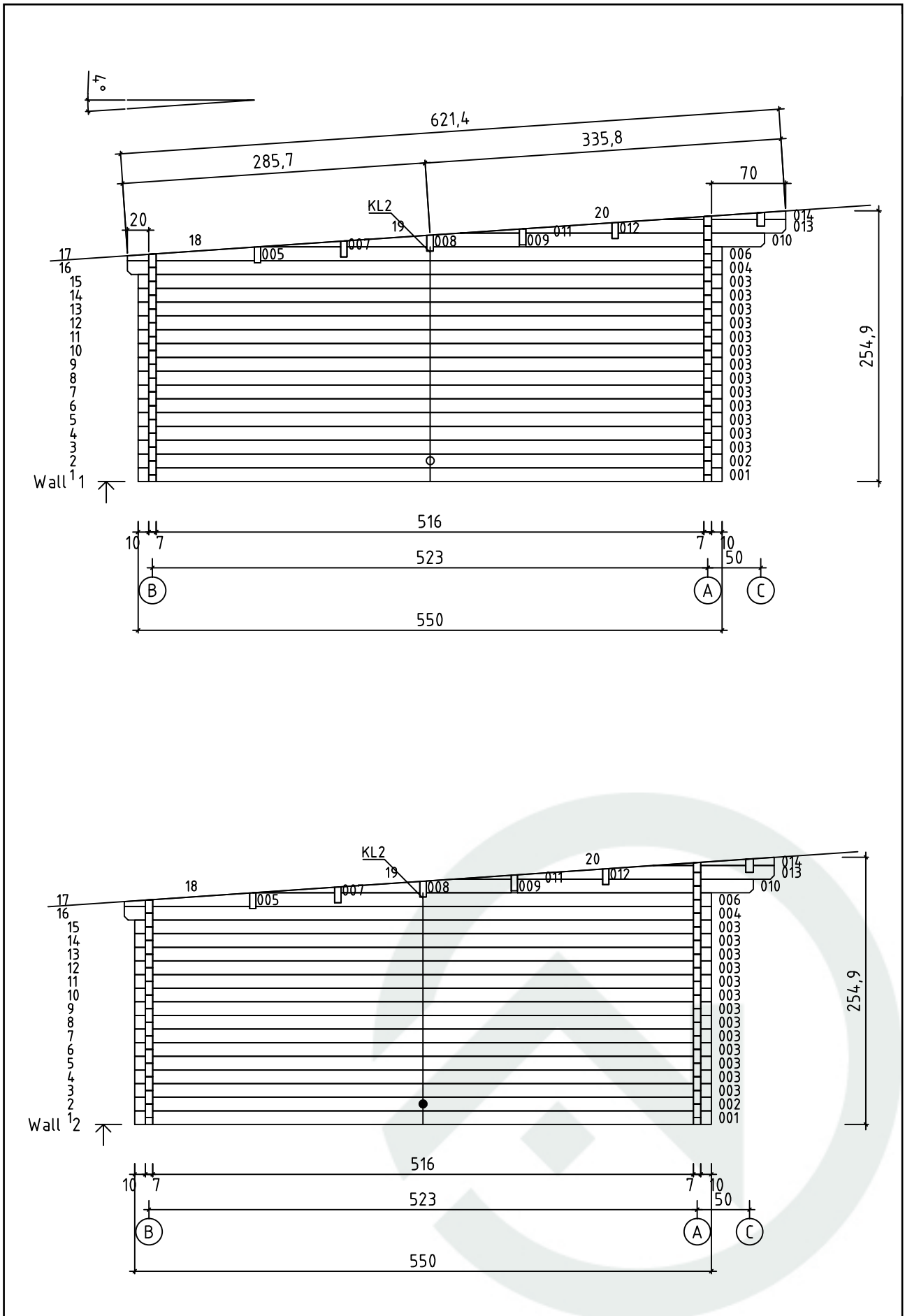



# Wandplan A und B 870965

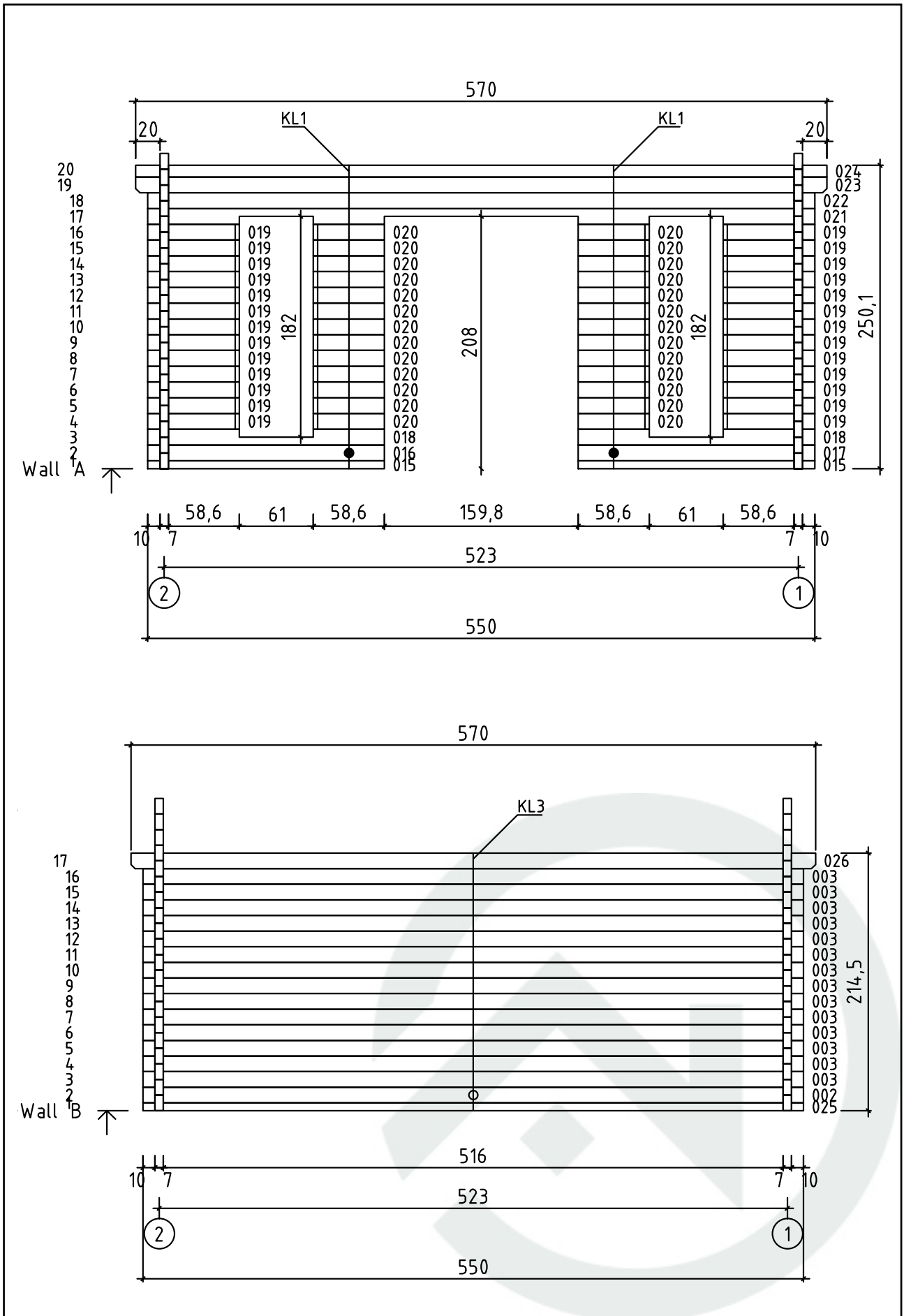

# Wandplan C 870965

## Vorgelagerte Vordachbohle vor Wand A

