

# Technische Daten: Art.-Nr.: 870962

Wandaußenmaß: 530 x 530 cm

Bohlenstärke: 70 mm



Kontrolliert durch:

Achtung: Alle angegebenen Maße sind ca.-Maße!

# 3D-Darstellung 870962

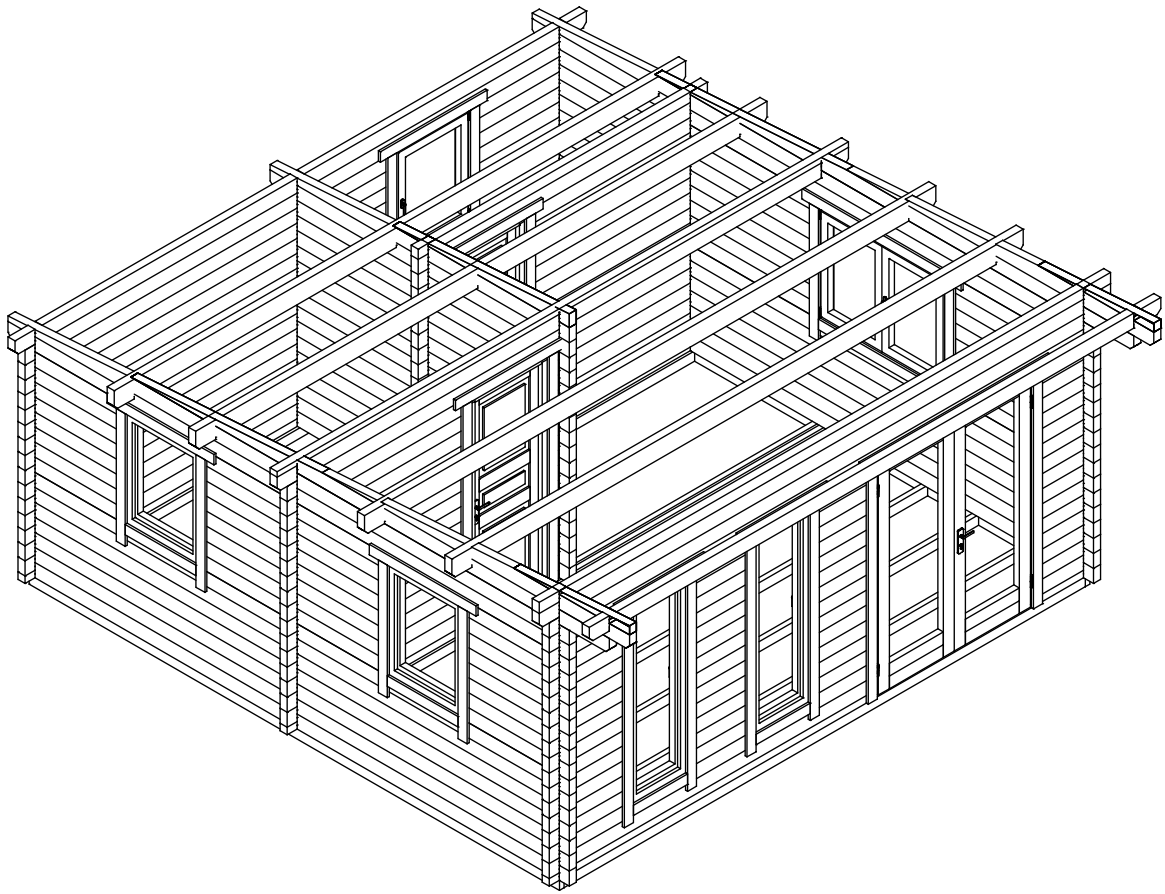

# Grundriss 870962

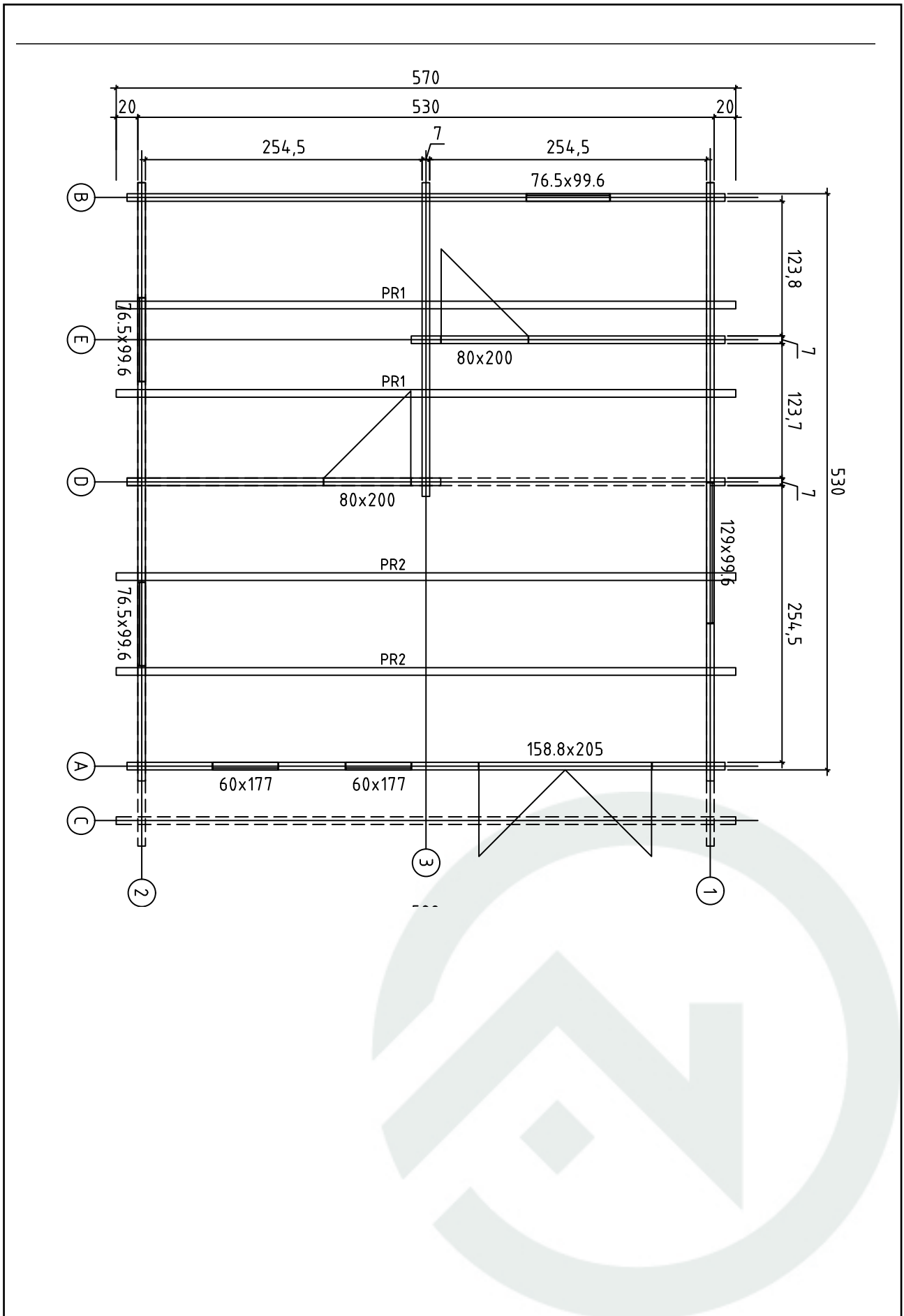

# Lagerholzplan und Fundamentplan 870962

Wir empfehlen als Fundament für Ihr Gartenhaus eine vollflächig festgegründete, gepflasterte oder betonierte Fläche.  
Wahlweise ist auch ein Punkt- oder Streifenfundament möglich.

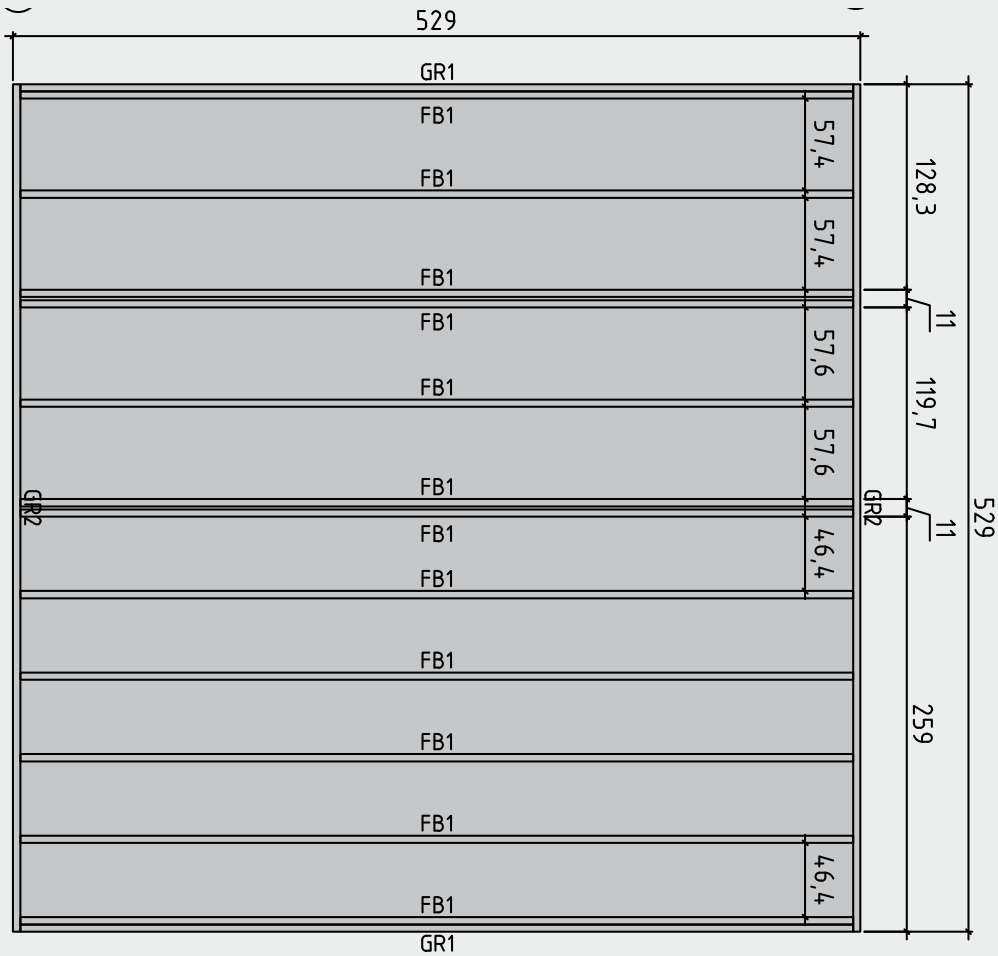







# Teilleiste 1

## 870962

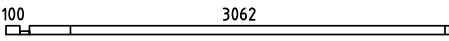
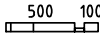
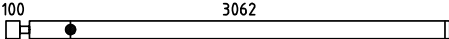
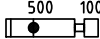
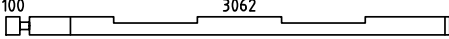
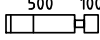
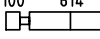
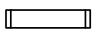
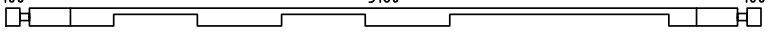
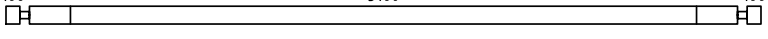
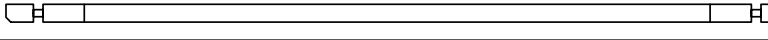
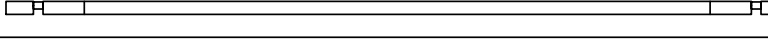
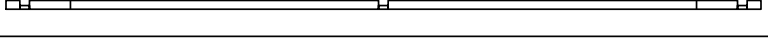
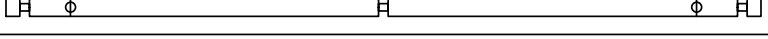
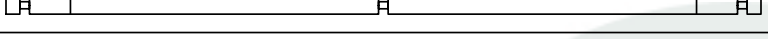
Pos		Quantity	Profil (mm)	Lenght (mm)
001		1	70x130	5500
002		6	70x130	5500
003		8	70x130	2754
004		8	70x130	1446
005		1	70x130	5600
006		3	70x128	1195
007		1	70x130	4345
008		1	70x130	2467
009		2	70x130	2248
010		2	70x38	557
011		2	70x97	842
012		2	70x130	1577
013		2	70x79	1155
014		1	70x130	5500
015		6	70x130	5500
016		16	70x130	1055
017		8	70x130	1840
018		1	70x130	5600
019		1	70x130	4345
020		1	70x130	2467
021		1	70x130	2885
022		14	70x130	2885
023		1	70x130	2985
024		1	70x130	1730
025		1	70x120	1760

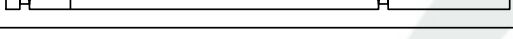
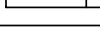

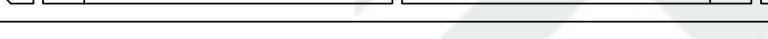

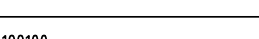
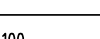
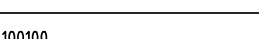
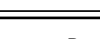





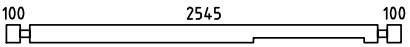
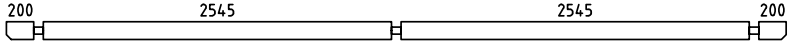
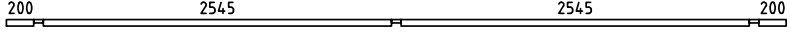
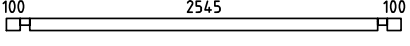
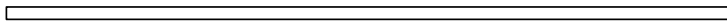

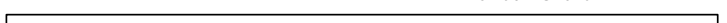
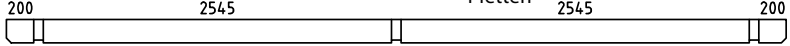
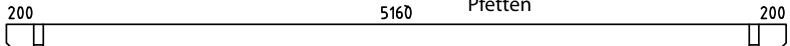
# Teileliste 2

## 870962

Pos		Quantity	Profil (mm)	Lenght (mm)
026		1	70x65	3232
027		1	70x65	670
028		1	70x130	3232
029		1	70x130	670
030		1	70x130	3232
031		14	70x130	670
032		13	70x130	784
033		26	70x130	614
034		1	70x130	5500
035		1	70x130	5500
036		1	70x130	5700
037		1	70x96	5700
038		1	70x65	5500
039		1	70x130	5500
040		5	70x130	5500
041		1	70x130	5500
042		7	70x130	3670
043		7	70x130	1055
044		1	70x130	5500
045		1	70x130	5700
046		1	70x130	5700
047		2	70x65	1805
048		2	70x65	270
049		30	70x130	1805
050		30	70x130	270





















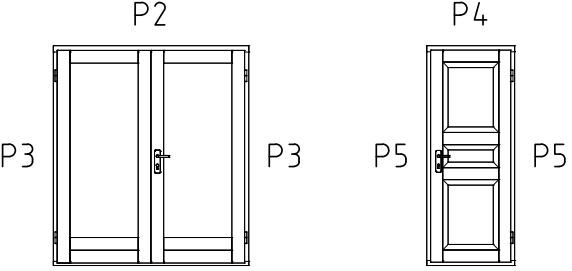
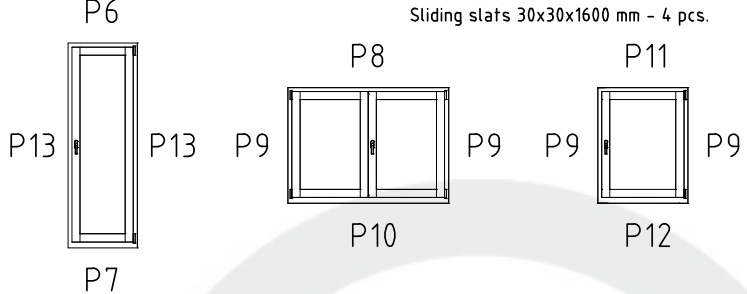



# Teilleiste 3

## 870962

Pos		Quantity	Profil (mm)	Lenght (mm)
051		2	70x130	2885
052		1	70x130	5700
053		1	70x48	5700
054		1	70x89	2885
GR2	Rahmen-Fundamentholz 	2	45x90	5290
GR1	Rahmen-Fundamentholz 	2	45x90	5200
FB1	Fundamentholz 	12	45x90	5200
PR1	Pfetten 	2	70x170	5700
PR2	Pfetten 	2	70x170	5700
	Fenster 600x1770	2		
	Fenster 765x996	3		
	Fenster 1290x996	1		
	Tür 800x2000	2		
	Tür 1588x2050	1		
1	Screws/Schrauben/Vis 5x100 mm- For fixing first row of wall logs /Fixierung des ersten Bohlenkranzes/Pour fixer les lames de plancher 	6		
2	Nails/Nägels/Clous 2.5x50 - For fixing floorboards/ Befestigung Fussbodenbretter/Pour fixer les lames de plancher 	650		
3	Nails/Nägels/Clous 2.5x50 - For fixing roofboards/ Befestigung Dachbretter/Pour fixer les voliges 	525		
4	Nails/Nägels/Clous 2.5x50 - For fixing floor edge trims/ Befestigung Fussleisten/Pour fixer les plinthes du plancher 	75		
5	Nails/Nägels/Clous 2.5x50 - For fixing roofing felt fillet/ Befestigung giebelabschlussbrett/Pour fixer la latte de finition de la couverture 	40		
6	Screws/Schrauben/Vis 2,5x50 mm- For fixing roof side boards and roof edge reinforcement Befestigung Traufenbretter und Traufleisten Pour fixer les planches de rive et le tasseau de refront 	175		
7	Screws/Schrauben/Vis 2,5x50 mm- For fixing fascia boards and diamonds/ Befestigung Giebelblende und Raute Pour fixer les planches de rive et le diamant 			
8	Screws/Schrauben/Vis 2,5x50 mm- For fixing fwindow and door trims/ Befestigung Fenster und türen/ Pour fixer les croisillons des fenetres et des portes 			
9	Metal storm Brace/Gewindestange/Tige filetee 10 mm 	4		
10	Shim,Nuts/Mutter ,U-Scheibe/ECrou,Rondelle 10 mm For fixing storm braces/ Pour fixer les anti tempete/ Für Sturmleisten Pour fixer les croisillons des fenetres et des portes  Metal storm Brace/Gewindestange/Tige filetee 10 mm KL1 M10 2,25 m 2 Screws 180 8 pcs. KL2 M10 2,60 m 2 Plastic caps 4 pcs.	4/4		

# Teilleiste 4

## 870962

POS	ST.	B	H	L	
FB1	Vt. spetsi				 FUNDMENTHOLZER
F1	3,2m <sup>2</sup>	28		1233	 FUSSBODENBRETTER
F2	13,1m <sup>2</sup>	28		2540	 FUSSBODENBRETTER
F3	9,8m <sup>2</sup>	28		3847	 FUSSBODENBRETTER
PR	4	70	170	5700	 DACHBALKEN
RB1	16,3m <sup>2</sup> 19,1m <sup>2</sup>	20		2857 3358	 DACHBRETTER
R1	2	20	140	5740	 Traufenbretter
R2	2	45	65	5700	 Traufenbretter
R3	4	20	140	3210	 Giebelabschlussleiste
R4	4	20	90	3210	 Giebelabschlussleiste
DR1 DR2	1 2	1588 800	2050 2000		 <p>Sliding slats 30x30x1900 mm - 2 pcs. Sliding slats 30x30x1600 mm - 4 pcs.</p>
WN1 WN2 WN3	2 1 3	600 1290 765	1770 996 996		
P1	38m	20	40		 Fussbodenleiste
P2	1+1	20	90	1890	 Türleiste DR1
P3	2+2	20	90	2030	 Türleiste DR1
P4	2+2	20	90	1100	 Türleiste DR2
P5	4+4	20	90	1980	 Türleiste DR2
P6	2+2	20	90	900	 Fensterleiste WN1
P7	2+2	20	90	540 <del>570</del>	 Fensterleiste WN1
P8	1+1	20	90	1590	 Fensterleiste WN2
P9	8+8	20	90	1150	 Fensterleiste WN2, WN3
P10	1+1	20	90	1230 <del>1260</del>	 Fensterleiste WN2
P11	3+3	20	90	1065	 Fensterleiste WN3
P12	3+3	20	90	705 <del>735</del>	 Fensterleiste WN3
P13	4+4	20	90	1920	 Fensterleiste WN1





# Wandplan 3 870962

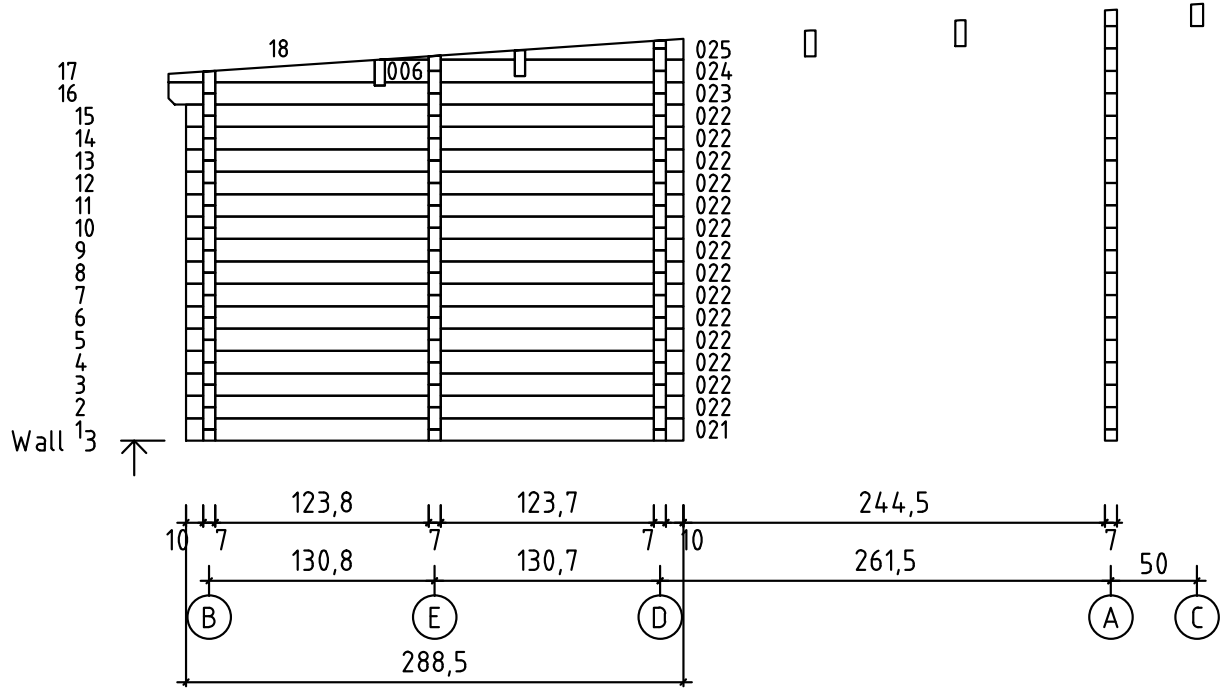

# Wandplan A und B 870962

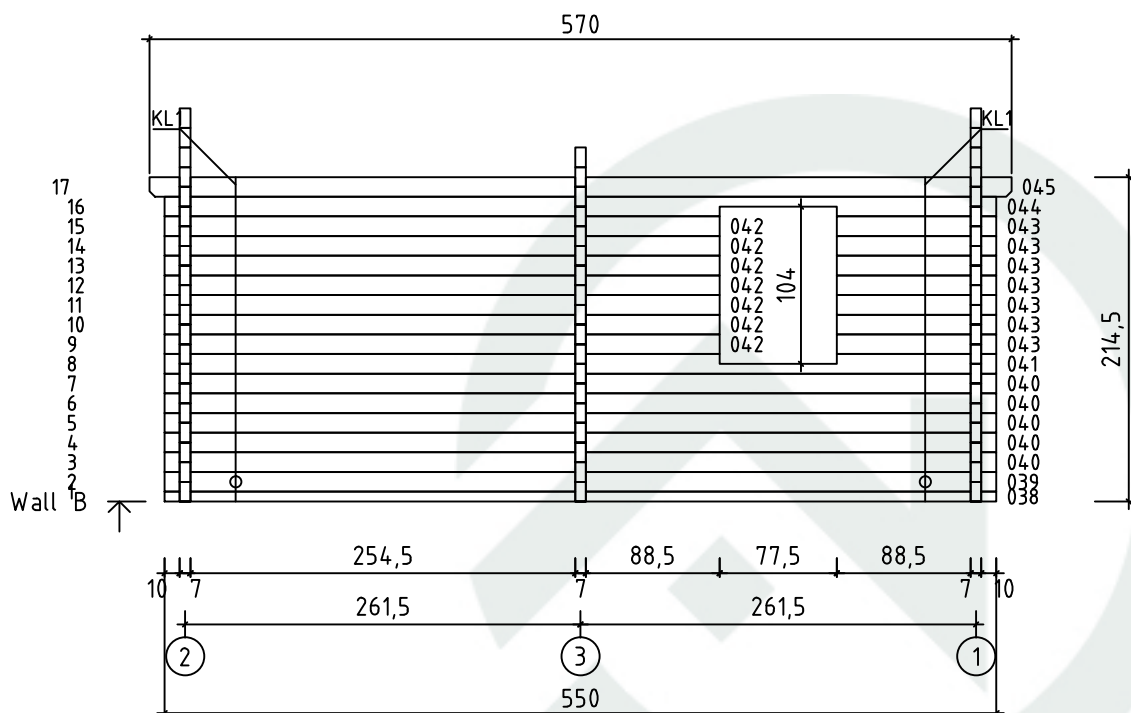
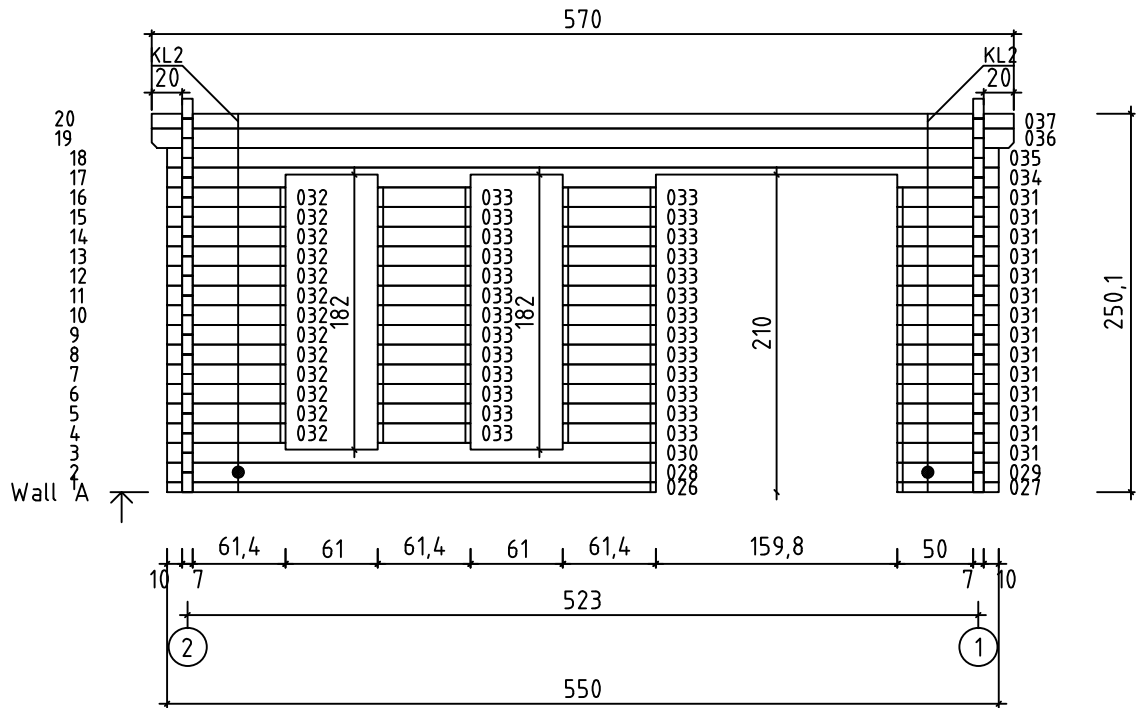

# Wandplan C und D

## 870962

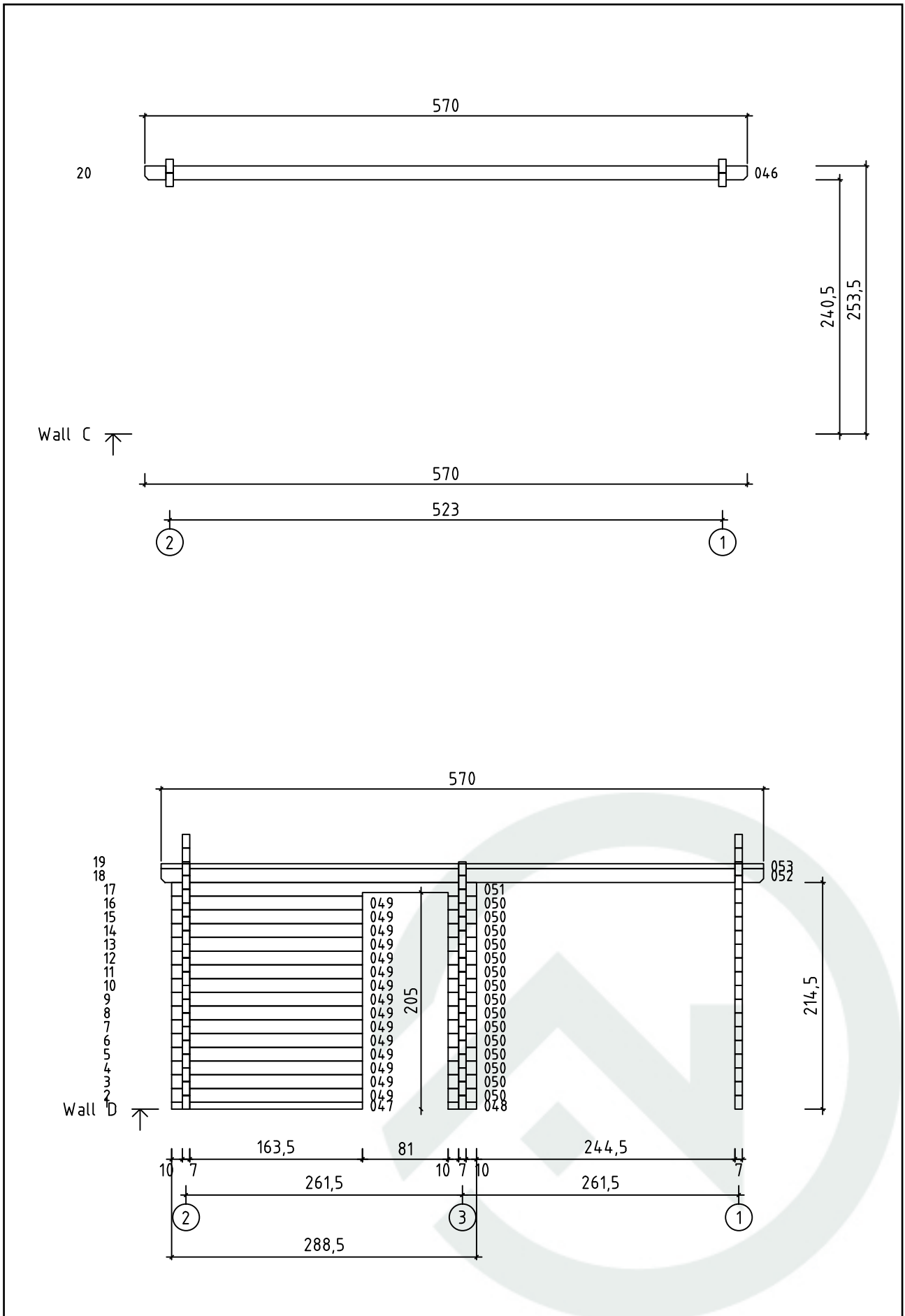

# Wandplan E 870962

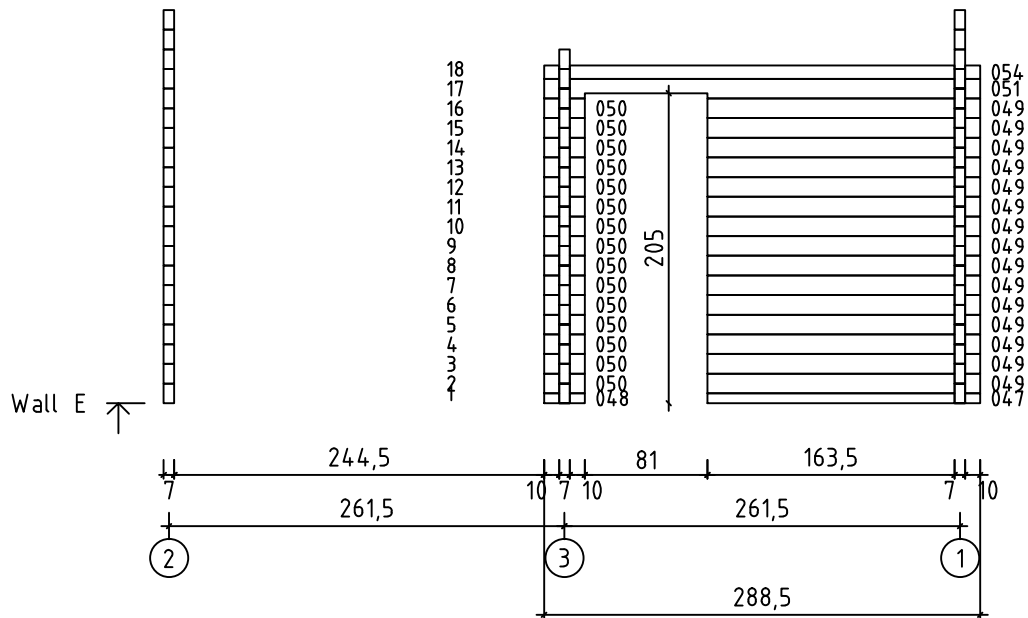

# Details 870962

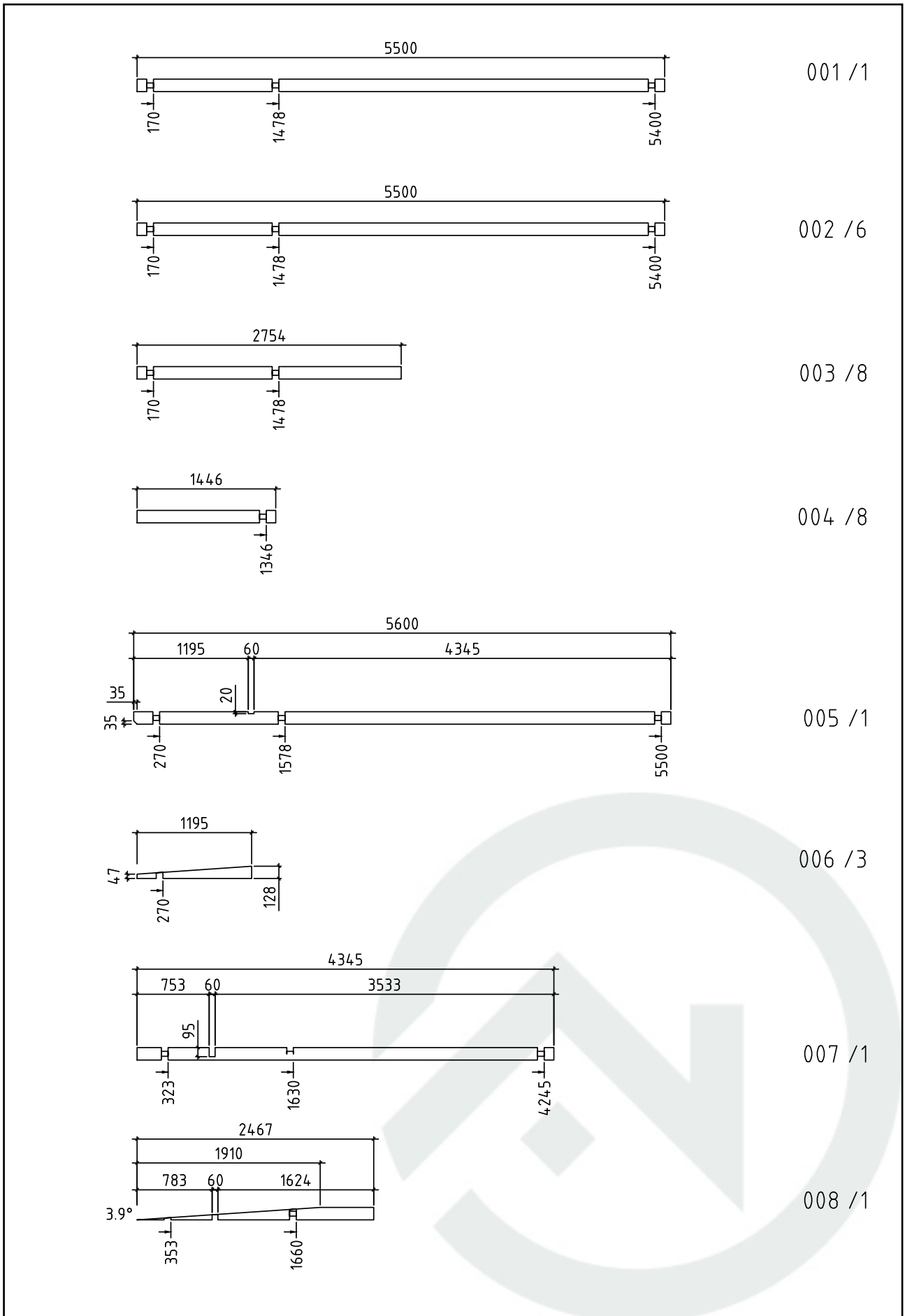

# Details 870962

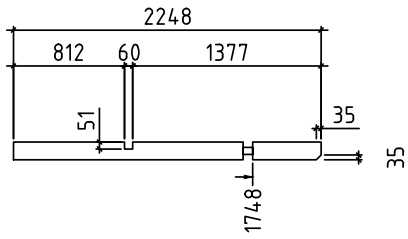

009 / 2

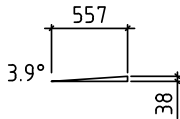

010 / 2

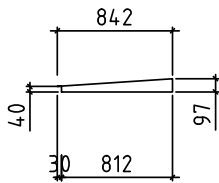

011 / 2

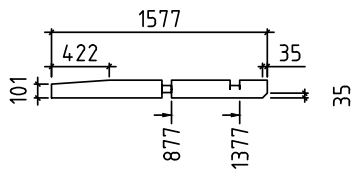

012 / 2

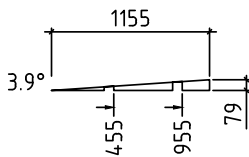

013 / 2

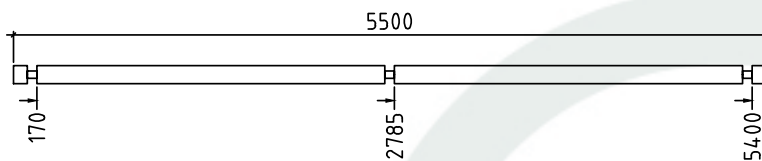

014 / 1

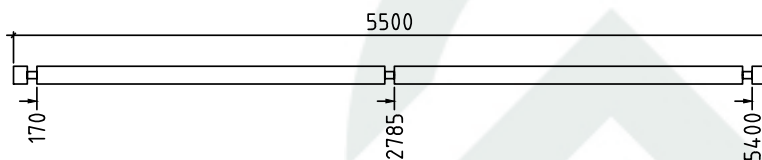

015 / 6

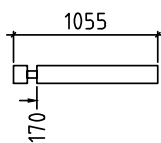

016 / 16

# Details 870962

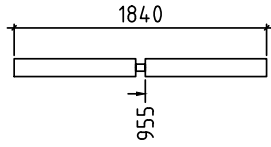

017 / 8

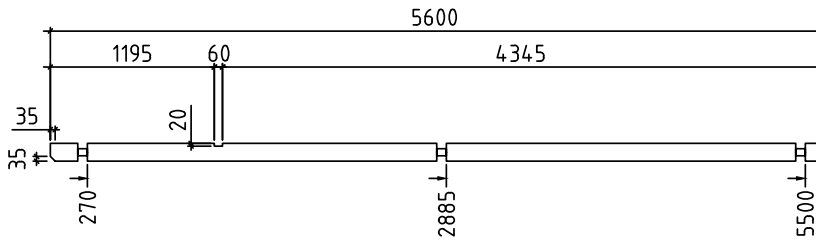

018 / 1

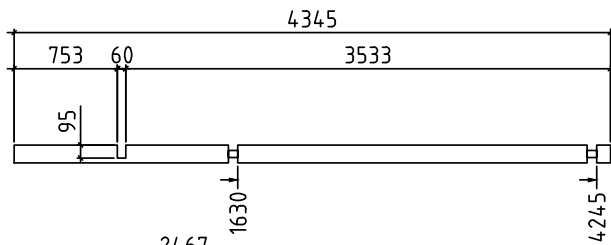

019 / 1

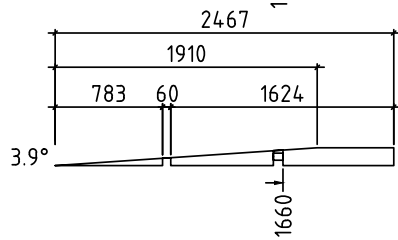

020 / 1

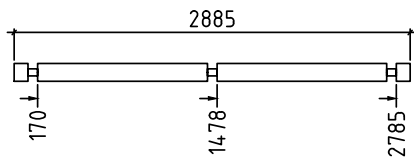

021 / 1

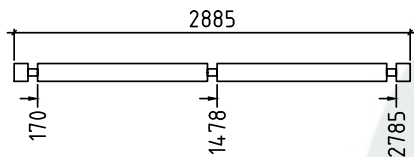

022 / 14

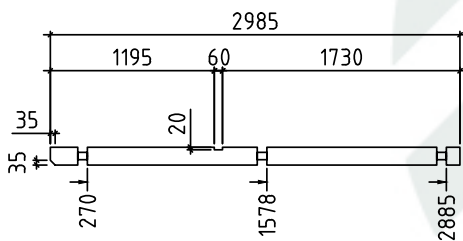

023 / 1



# Details 870962

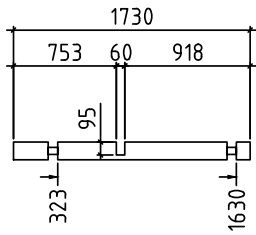

024 /1

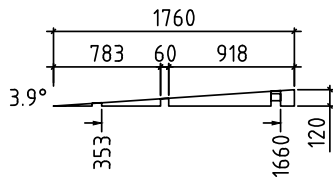

025 /1

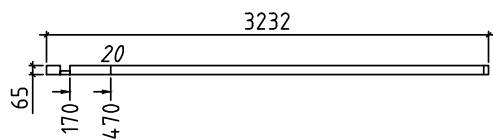

026 /1

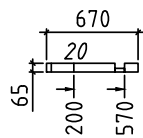

027 /1

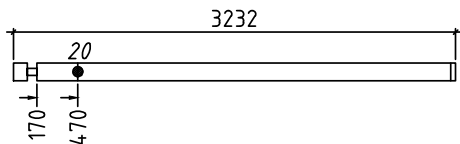

028 /1

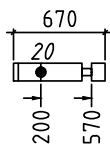

029 /1

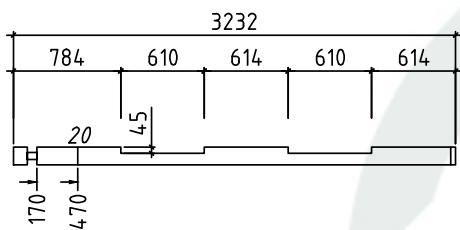

030 /1

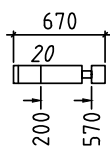

031 /14

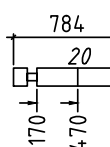

032 /13

# Details 870962

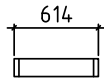

033 /26

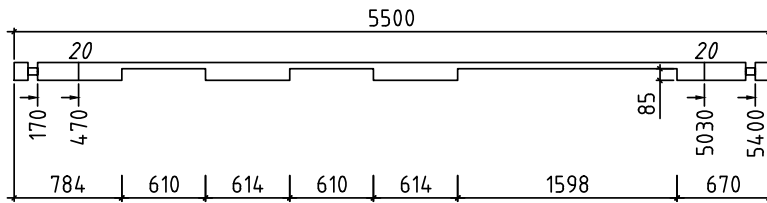

034 /1

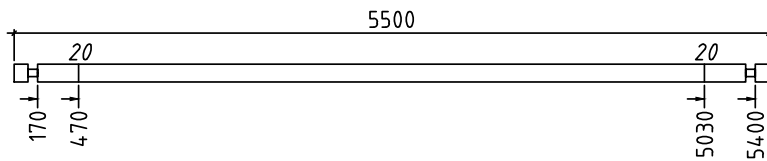

035 /1

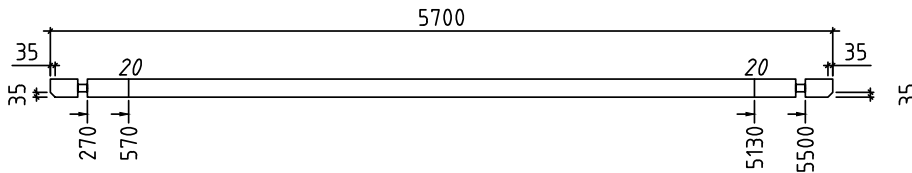

036 /1

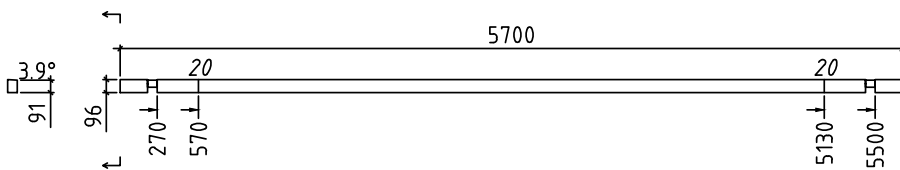

037 /1

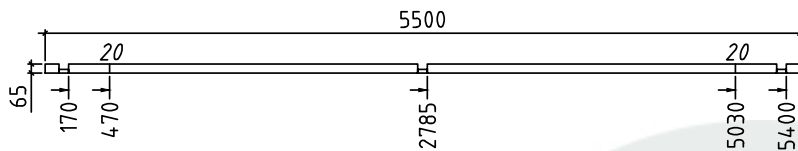

038 /1

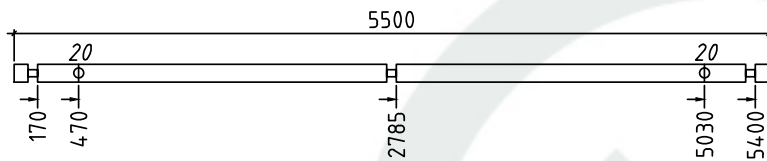

039 /1

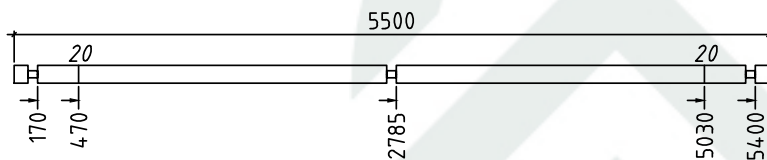

040 /5

# Details 870962

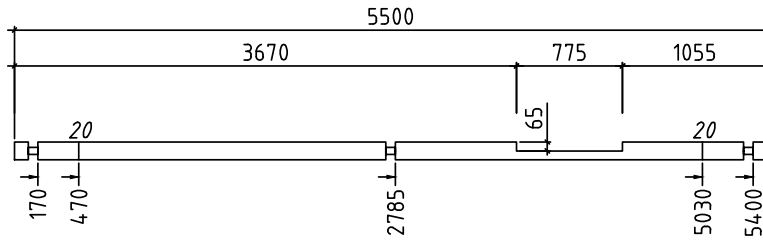

041 / 1

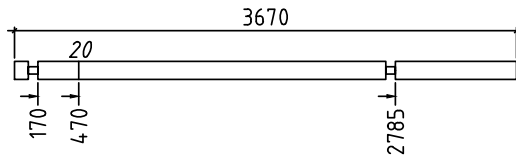

042 / 7

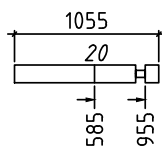

043 / 7

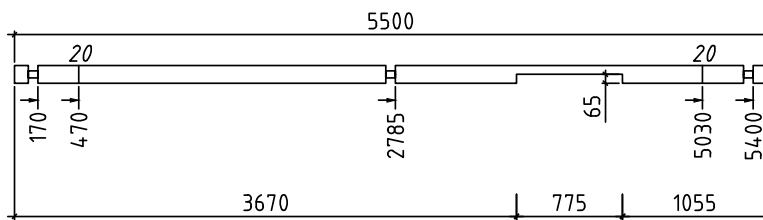

044 / 1

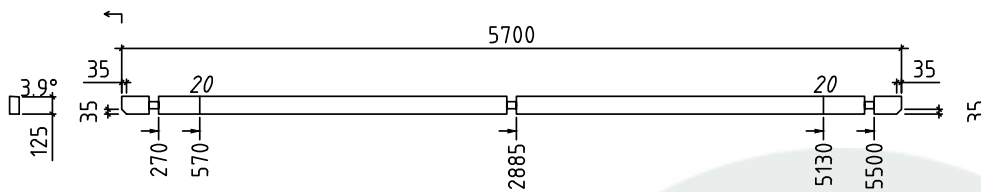

045 / 1

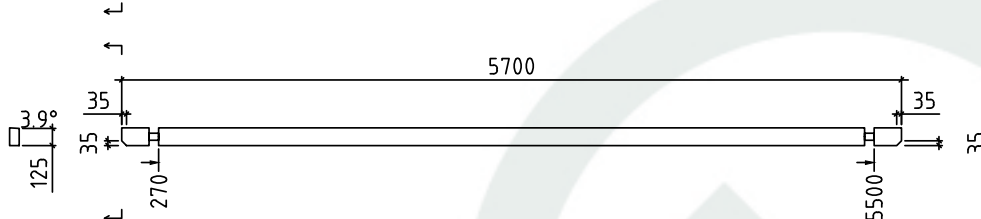

046 / 1

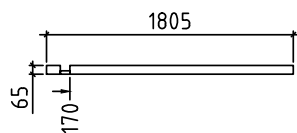

047 / 2

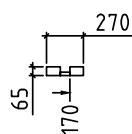

048 / 2

# Details 870962

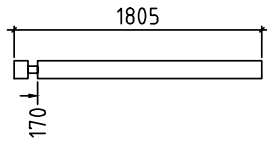

049 /30

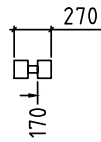

050 /30

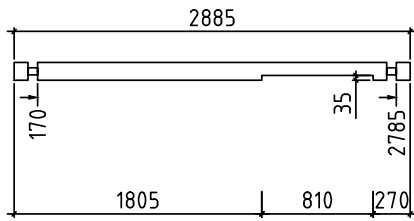

051 /2

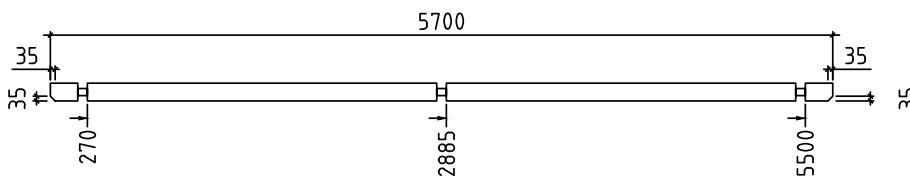

052 /1

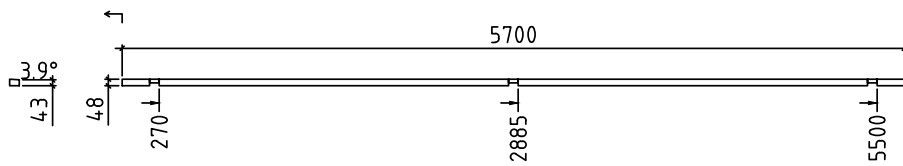

053 /1

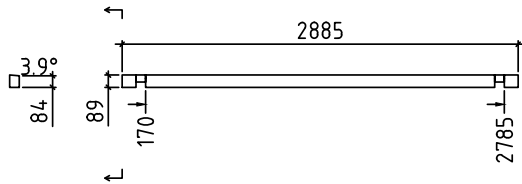

054 /1

# Details 870962

## Rahmen-Fundamentholz

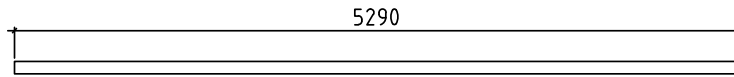

GR2 /2  
45x90

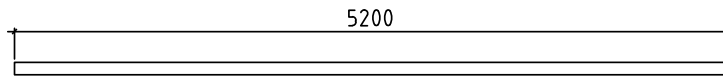

GR1 /2  
45x90

## Fundamentholz

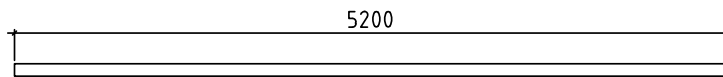

FB1 /12  
45x90

## Pfetten

