

Technische Daten: Art.-Nr.: 870915

Wandaußenmaß: 360 x 360 cm

Bohlenstärke: 70 mm



Trondheim 70-D XL

Kontrolliert durch:

Empty box for signature or name.

Achtung: Alle angegebenen Maße sind ca.-Maße!

3D-Darstellung und Grundriss 870915

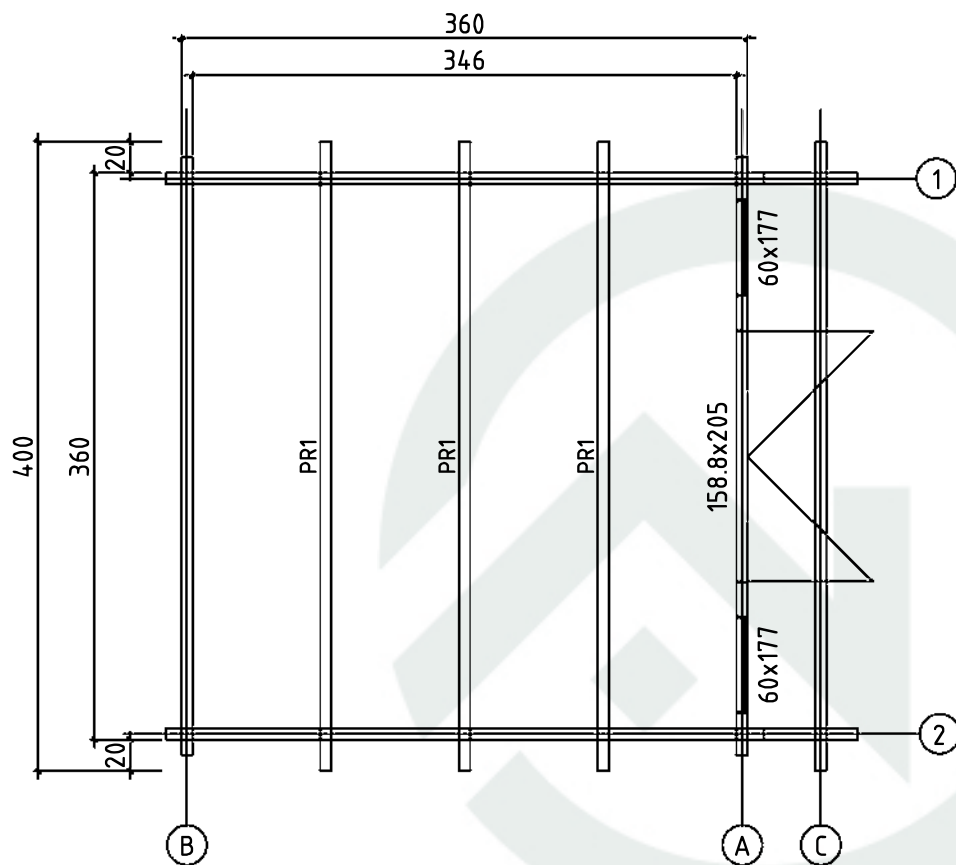
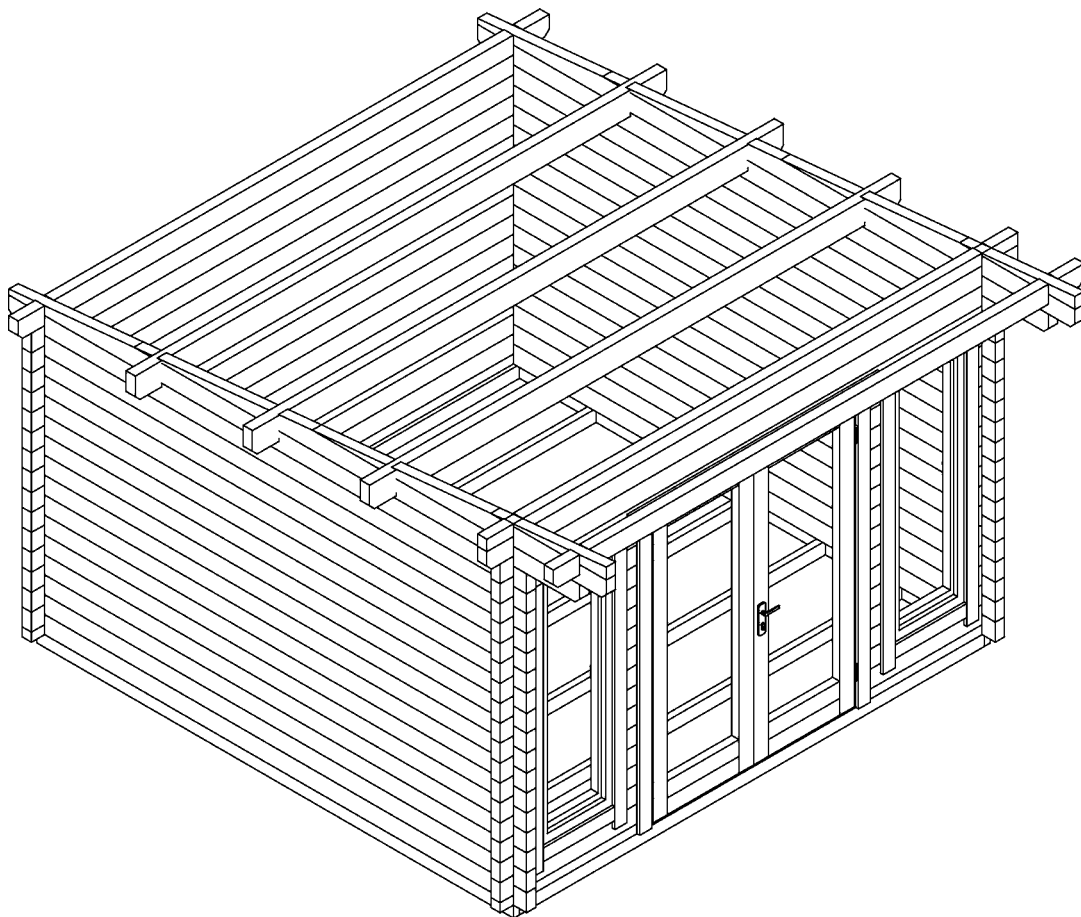



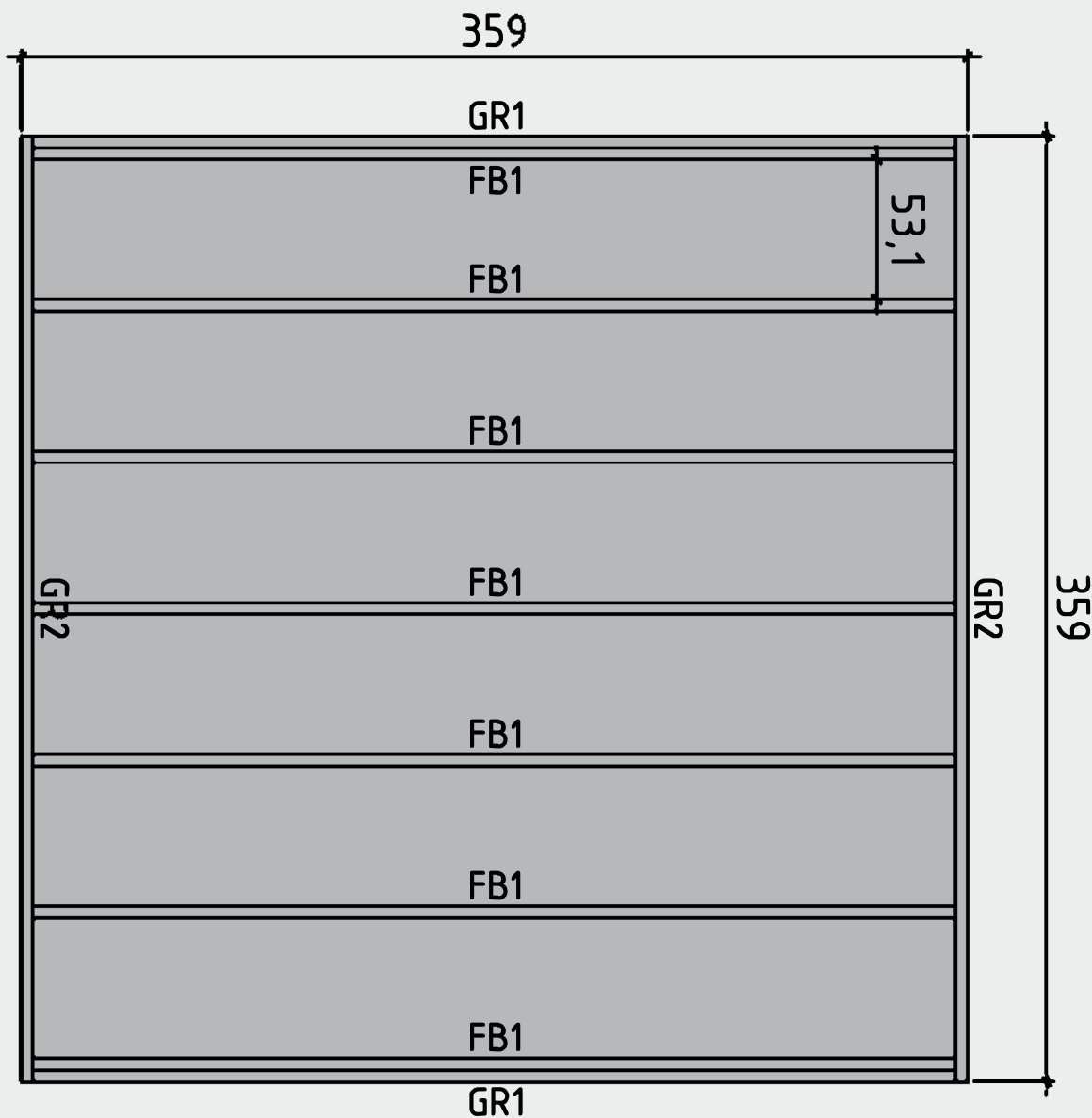

Lagerholzplan und Fundamentplan 870915

Wir empfehlen als Fundament für Ihr Gartenhaus eine vollflächig,
festgegründete gepflasterte oder betonierte Fläche.
Wahlweise ist auch ein Punkt- oder Streifenfundament möglich.



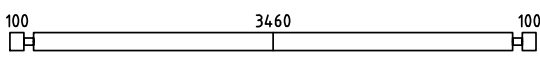
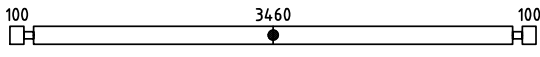
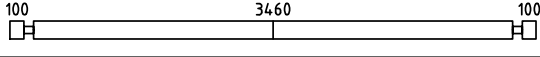
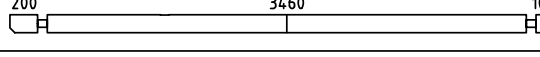
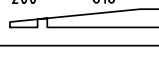
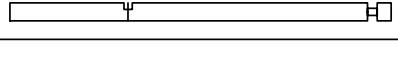
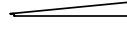
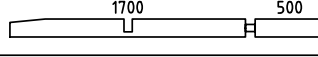

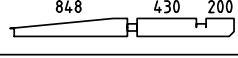
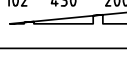
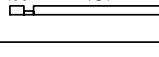
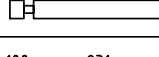
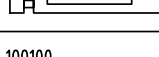

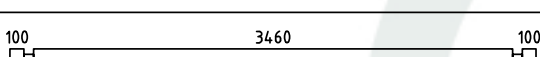
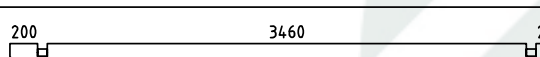
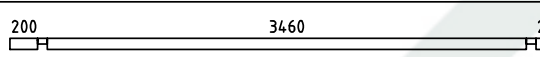
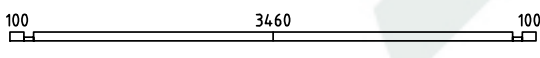
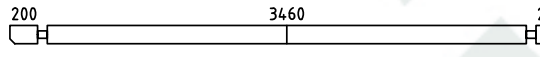
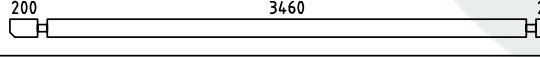
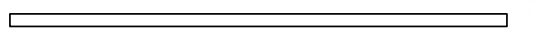
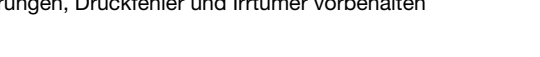





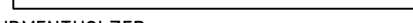

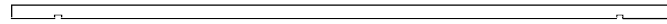

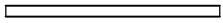

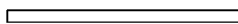
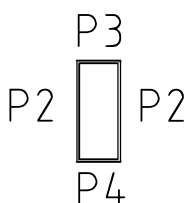
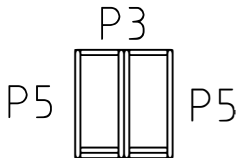

Teileliste 1

870915

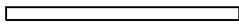
Pos			Profil (mm)	Lenght (mm)
001		2	70x130	3800
002		3	70x130	3800
003		40	70x130	3800
004		2	70x130	3900
005		2	70x130	1088
006		2	70x130	2753
007	—	2	70x14	146
008		2	70x100	852
009		2	70x130	2270
010		2	70x55	568
011		2	70x130	1618
012		2	70x84	872
013		2	70x65	1101
014		2	70x130	1101
015		2	70x130	1101
016		26	70x130	270
017		26	70x130	221
018		1	70x130	3800
019		1	70x130	3800
020		1	70x130	4000
021		1	70x82	4000
022		1	70x65	3800
023		1	70x130	4000
024		1	70x130	4000
GR2		2	45x90	3590

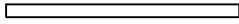
Teileliste 3

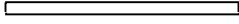
870915

POS	ST.	B	H	L	Teileliste		
FB1	Vt. spetsi					FUNDMENTHOLZER	
F1	12m ²	28		3455		FUSSBODENBRETTER	
PR	3	70	170	4000		DACHBALKEN	
RB1	18,1m ²	20		4521		DACHBRETTER	
R1	2	20	140	4040	Vaata kätuse kaloenurka 	Trafenbretter	
R2	2	45	65	4000	Vaata kätuse kaloenurka 	Trafenbretter	
R3	2	20	140	4720	Vaata kätuse kaloenurka 	Giebelabschlussleiste	
R4	2	20	90	4720		Giebelabschlussleiste	
WN06	2	600	1770				Sliding slats 30x30x1600 mm - 4 pcs.
DR16	1	1588	2050				
P1	15m	20	40			Fußbodenleiste	
P2	4+4	20	90	1920		Fensterleiste WN 06	
P3	1+1	20	90	3440		Türleiste DR 16, Fensterleiste WN 06	
P4	2+2	20	90	540 570		Fensterleiste WN 06	
P5	2+2	20	90	2030		Türleiste DR 16	

Detailzeichnungen 870915

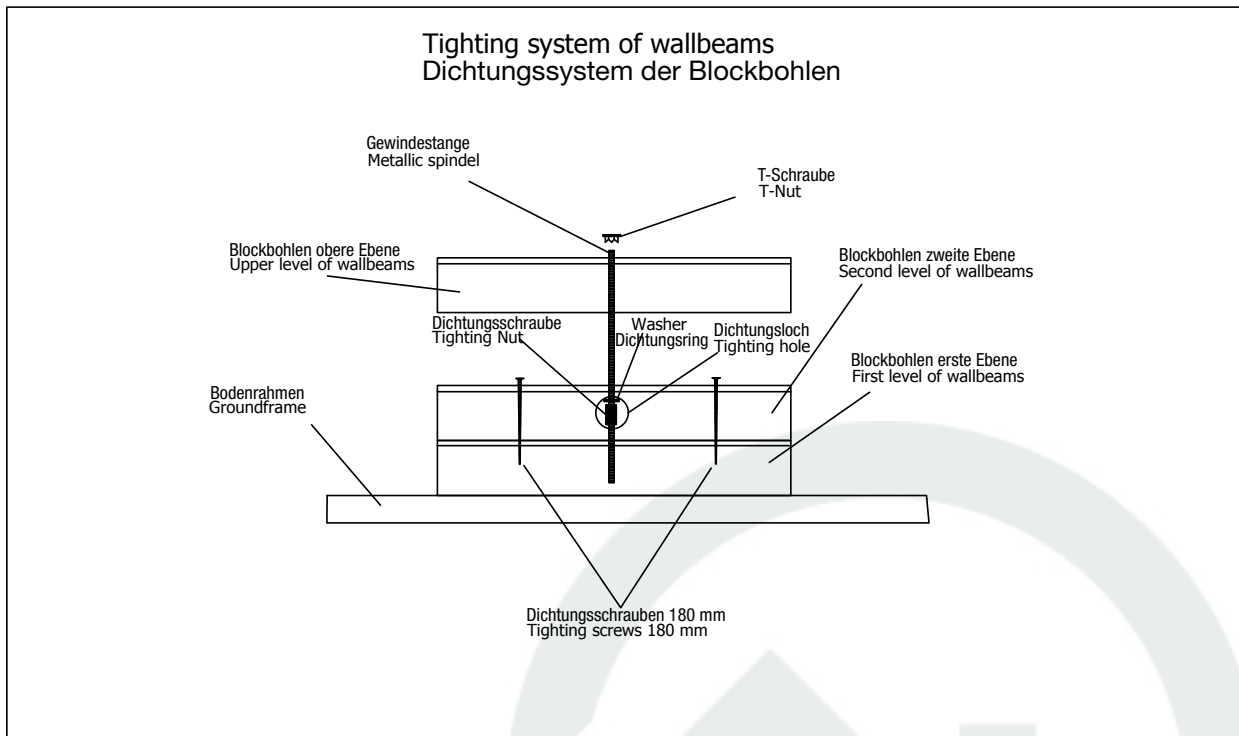
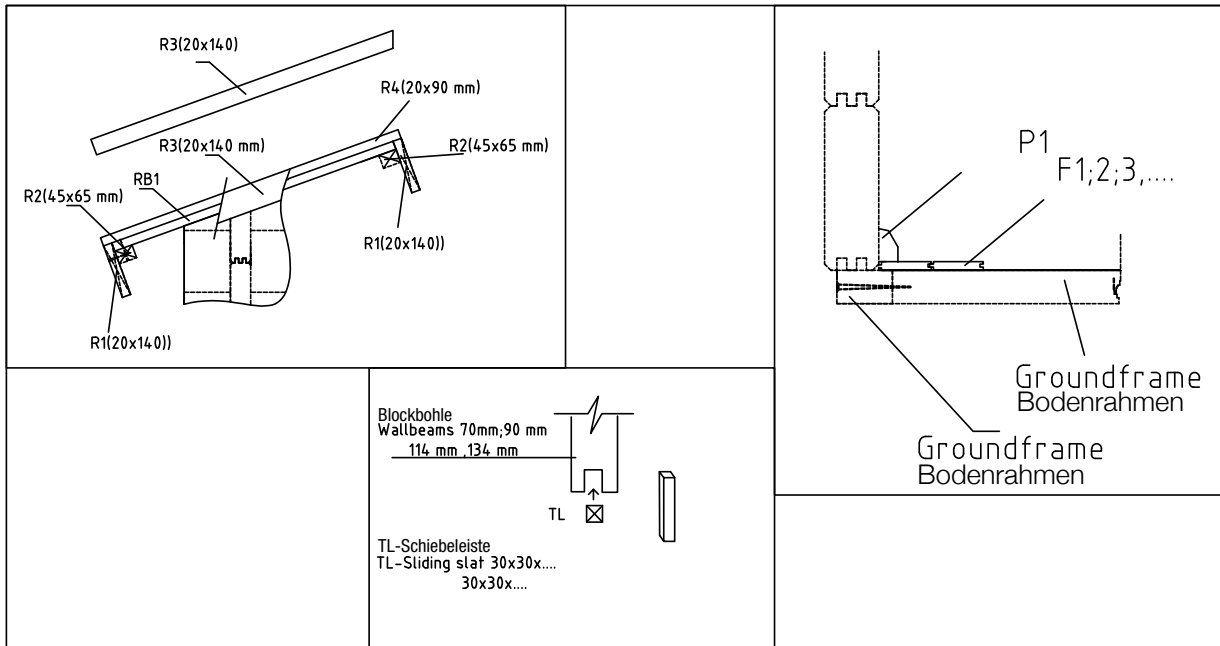

Wandplan 1 und 2 870915

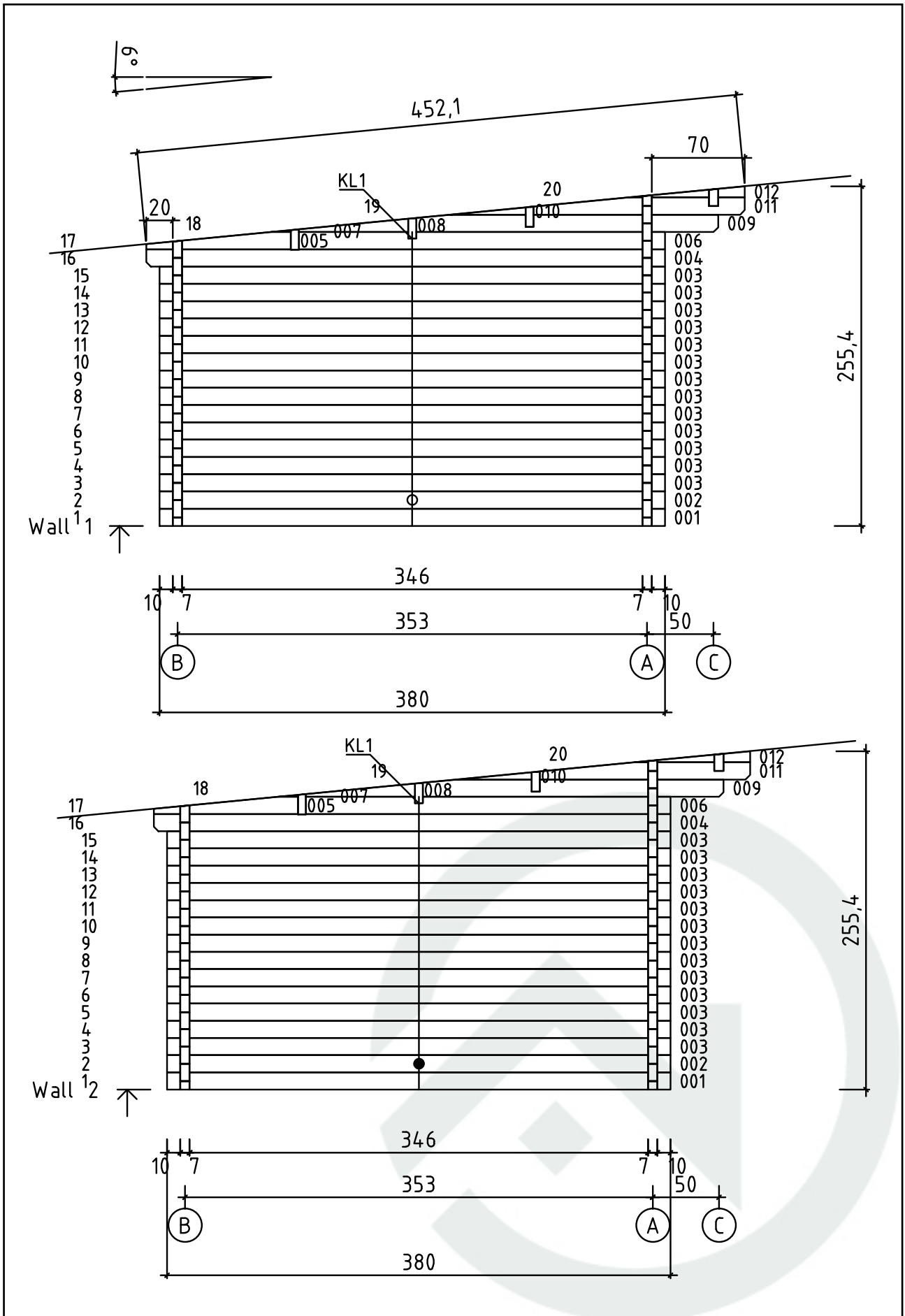

Wandplan A und B 870915

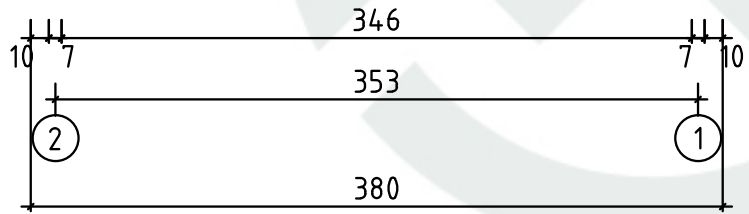
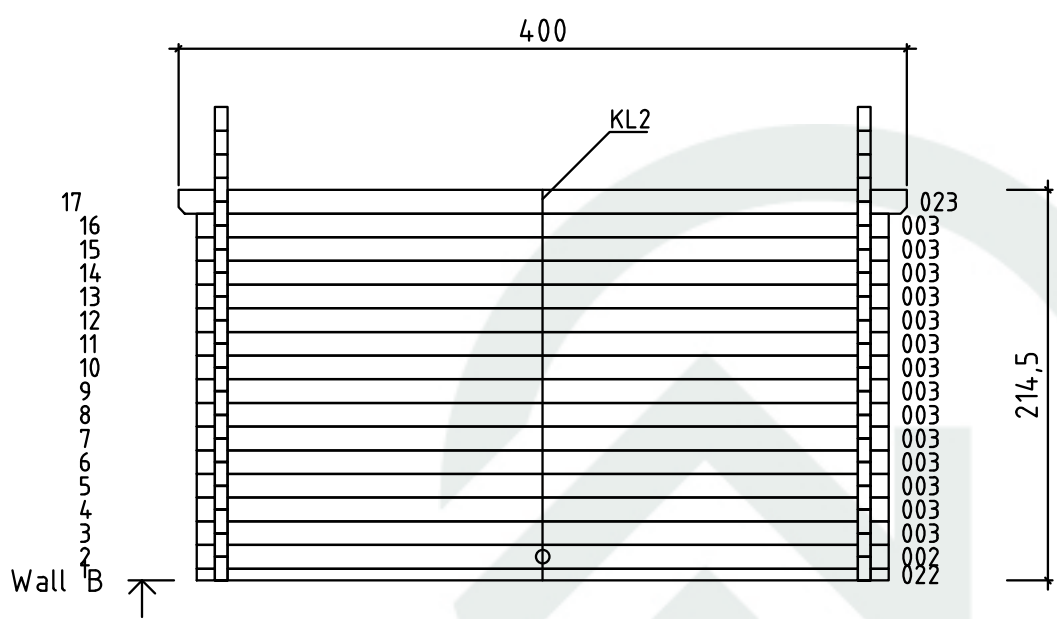
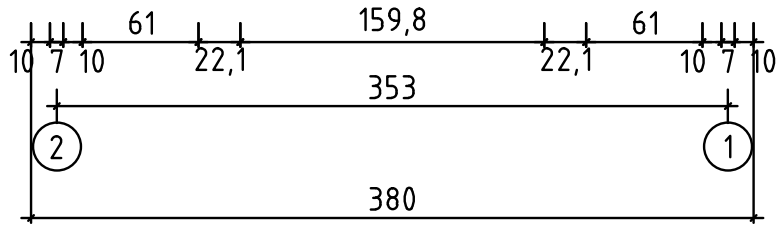
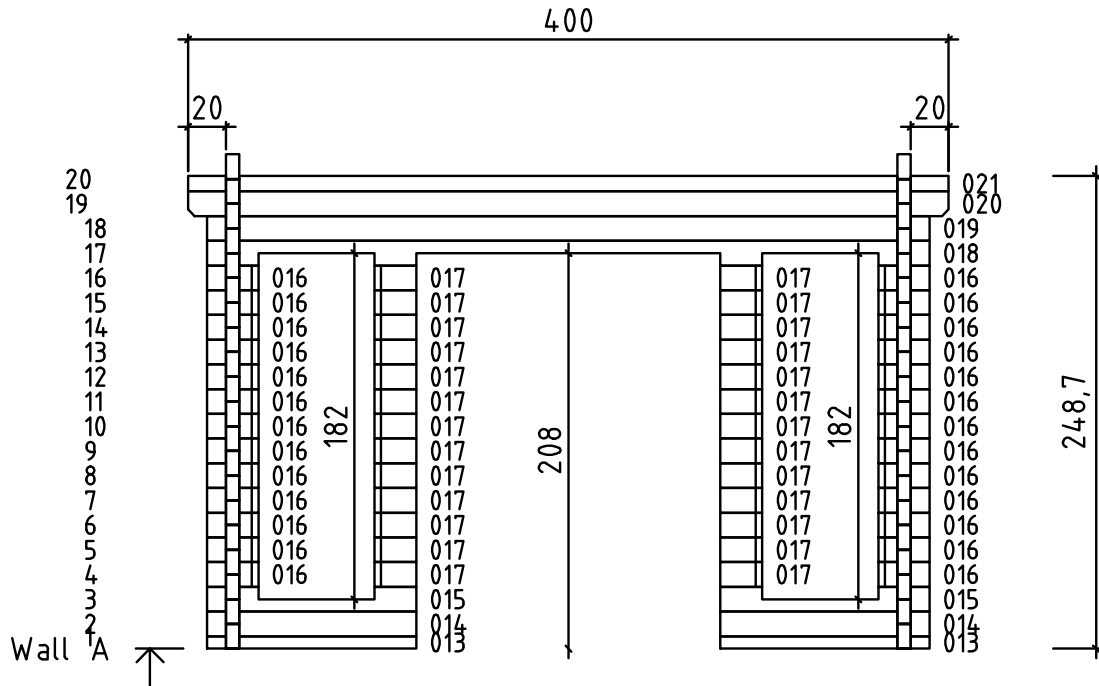

Wandplan C 870915

Vorgelagerte Vordachbohle vor Wand A

