

Technische Daten: Art.-Nr.: 870835

Wandaußenmaß: 450 x 360 cm

Bohlenstärke: 70 mm



Kontrolliert durch:

Empty box for signature or name.

Achtung: Alle angegebenen Maße sind ca.-Maße!

3D-Darstellung und Grundriss 870835

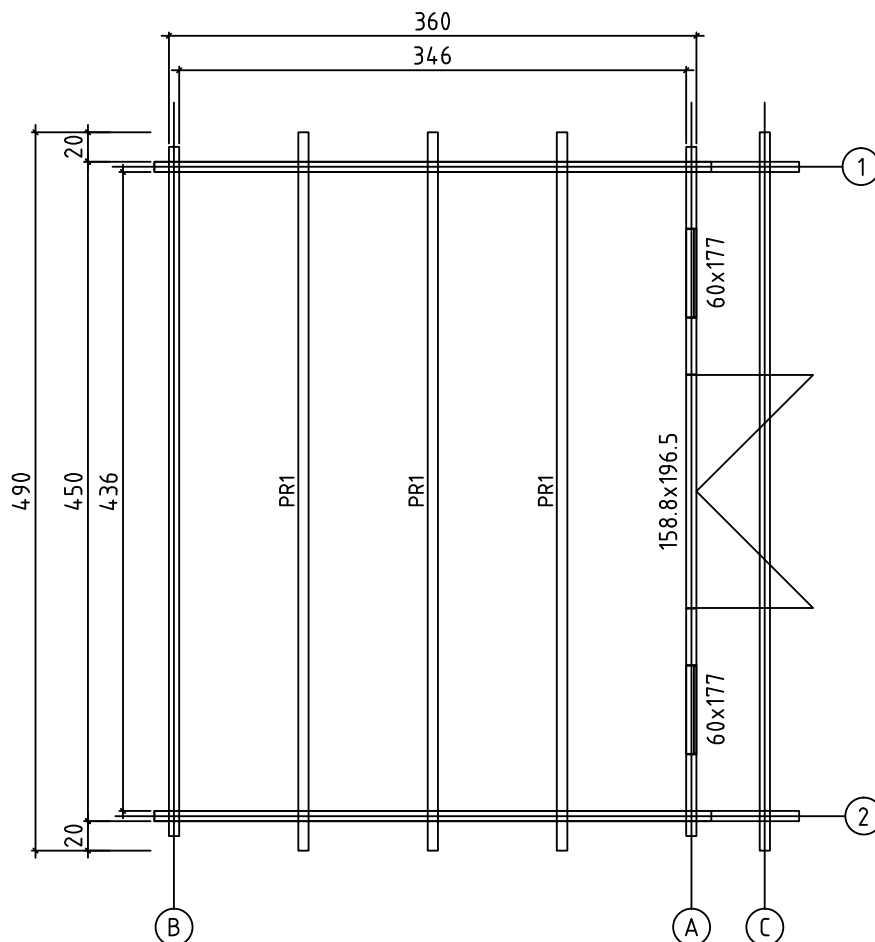
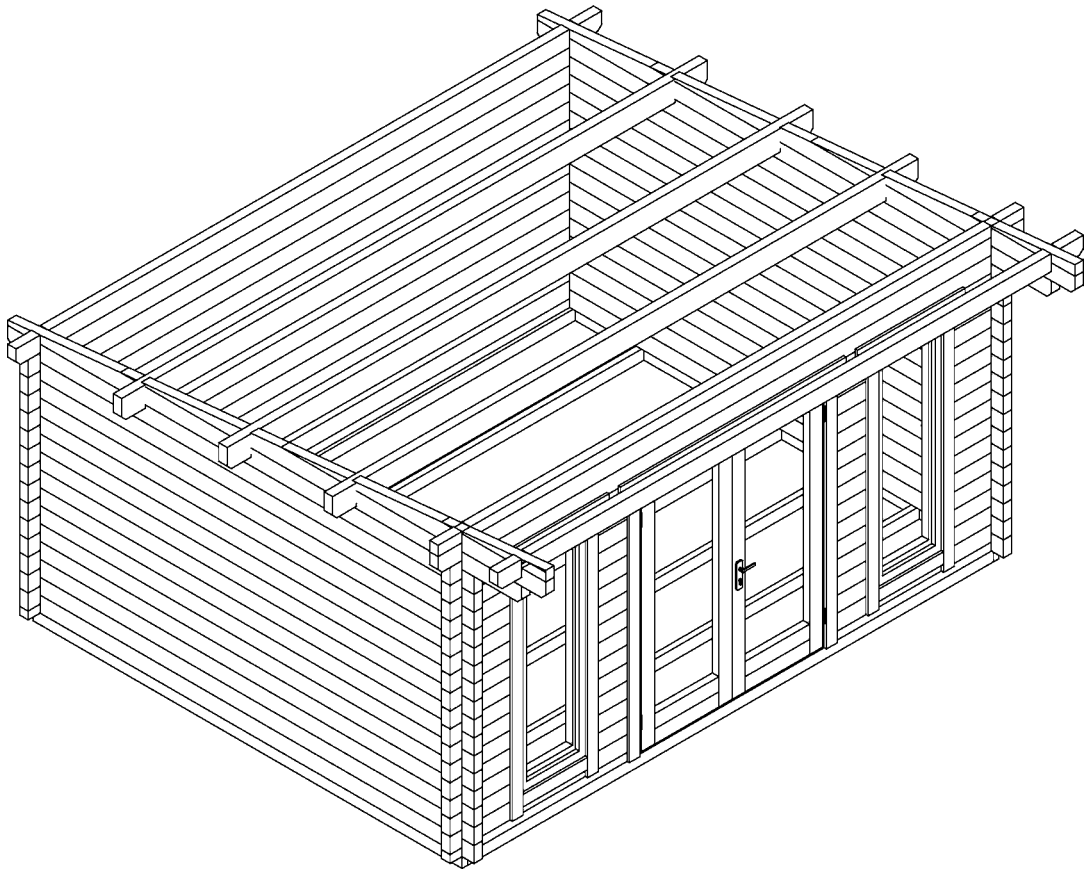





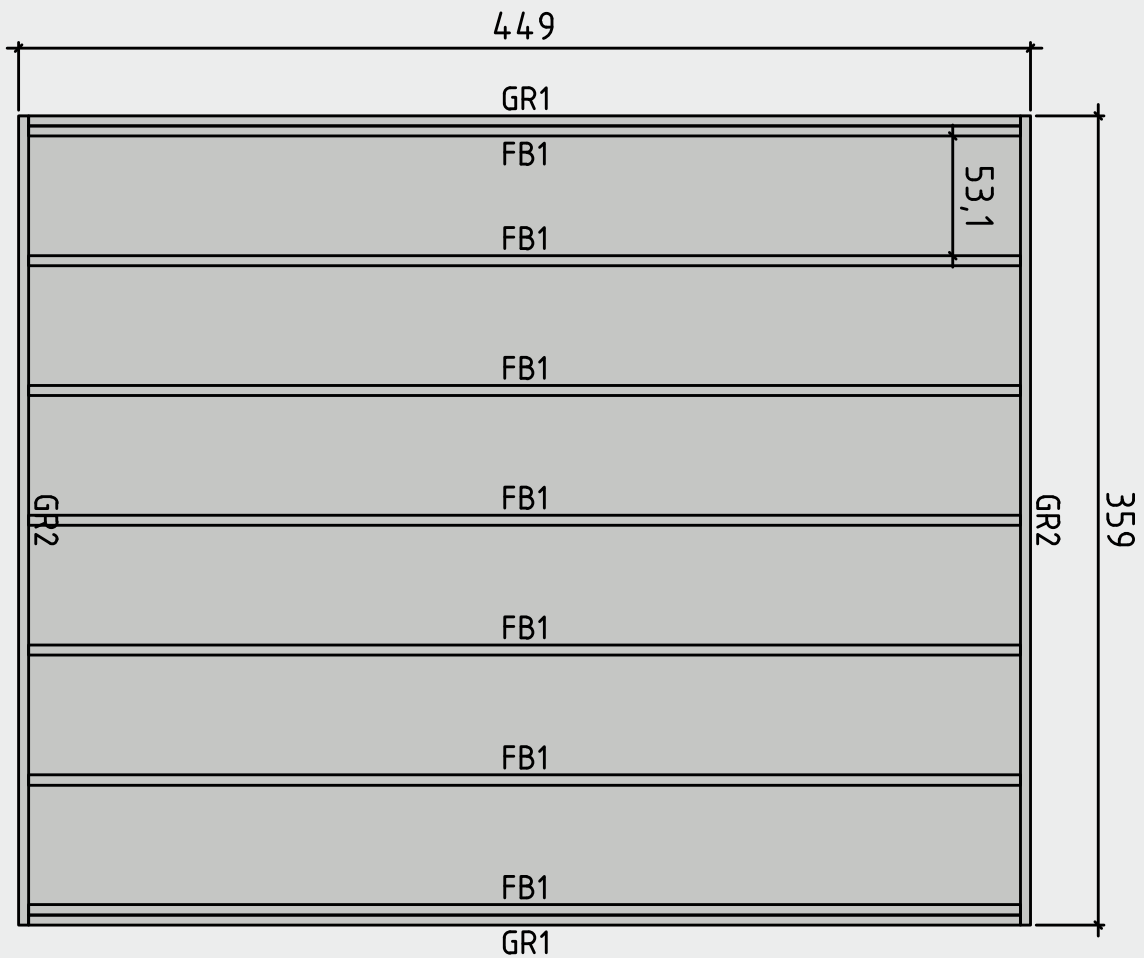

Lagerholzplan und Fundamentplan 870835

Wir empfehlen als Fundament für Ihr Gartenhaus eine vollflächig festgegründete, gepflasterte oder betonierte Fläche.
Wahlweise ist auch ein Punkt- oder Streifenfundament möglich.

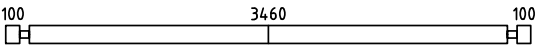
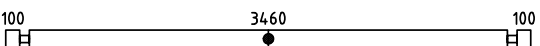
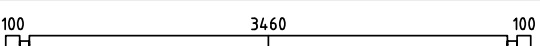
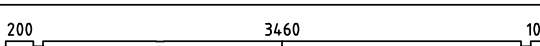
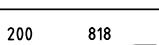
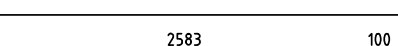

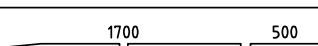

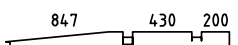
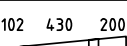
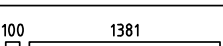
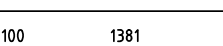

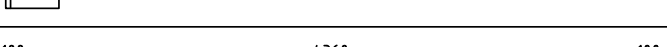
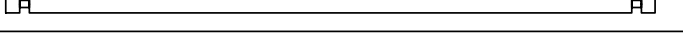
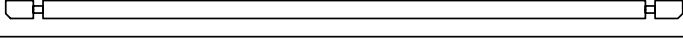
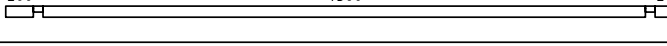
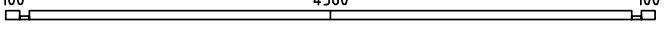
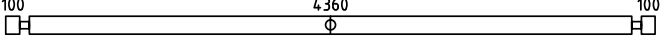
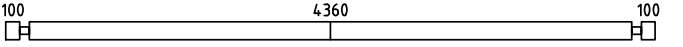
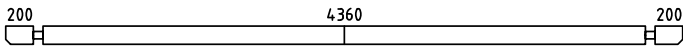
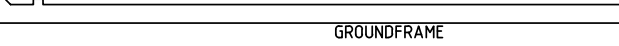



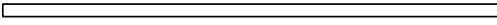
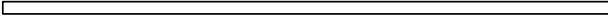
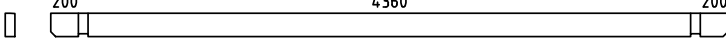

Teileliste 1

870835

Pos			Profil (mm)	Lenght (mm)
001		2	70x130	3800
002		2	70x130	3800
003		24	70x130	3800
004		2	70x130	3900
005		2	70x130	1088
006		2	70x130	2753
007	—	2	70x14	146
008		2	70x100	853
009		2	70x130	2270
010		2	70x55	567
011		2	70x130	1617
012		2	70x84	872
013		2	70x65	1551
014		2	70x130	1551
015		28	70x130	556
016		28	70x130	385
017		1	70x130	4700
018		1	70x130	4900
019		1	70x82	4900
020		1	70x65	4700
021		1	70x130	4700
022		13	70x130	4700
023		1	70x130	4900
024		1	70x130	4900
GR1	GROUNDFRAME 	2	45x90	4400

Teileliste 2

870835

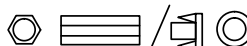
Pos			Profil (mm)	Lenght (mm)
GR2	GROUNDFRAME 		45x90	3590
FB1	FLOORBEAMS 		45x90	4400
PR1	Purlins 200 4360 200 		70x170	4900
	WINDOW 600x1770			
	DOOR 1588x1965			
1	Screws/Schrauben/Vis 5x100 mm- For fixing first row of wall logs /Fixierung des ersten Bohlenkranzes/Pour fixer les lamesde plancher 			6
2	Nails/Nägél/Clous 2.5x50 - For fixing floorboards/ Befestigung Fussbodenbretter/Pour fixer les lames de plancher 			350
3	Nails/Nägél/Clous 2.5x50 - For fixing roofboards/ Befestigung Dachbretter/Pour fixer les voliges 			350
4	Nails/Nägél/Clous 2.5x50 - For fixing floor edge trims/ Befestigung Fussleisten/Pour fixer les plinthes du plancher 			30
5	Nails/Nägél/Clous 2.5x50 - For fixing roofing felt fillet/ Befestigung giebelabschlussbrett/Pour fixer la latte de finition de la couverture 			30
6	Screws/Schrauben/Vis 2,5x50 mm- For fixing roof side boards and roof edge reinforcement Befestigung Traufenbretter und Traufenleisten Pour fixer les planches de rive et le tasseau de refront 			150
7	Screws/Schrauben/Vis 2,5x50 mm- For fixing fascia boards and diamonds/ Befestigung Giebelblende und Raute Pour fixer les planches de rive et le diamant 			
8	Screws/Schrauben/Vis 2,5x50 mm- For fixing fwindow and door trims/ Befestigung Fenster und türen/ Pour fixer les croissilons des fenetres et des portes 			
9	Metal storm Brace/Gewindestange/Tige filetee 10 mm 			3
10	Shim;Nuts/Mutter ,U-Scheibe/Ecrou;Rondelle 10 mm For fixing storm braces/ Pour fixer les anti tempete/ Für Sturmleisten Pour fixer les croissilons des fenetres et des portes  Metal storm Brace/Gewindestange/Tige filetee 10 mm KL1 M10 2,11 m 1 Screws 180 6 pcs. KL2 M10 2,18 m 2 Plastic caps 3 pcs.			3/3

Teileliste 3

870835

POS	ST.	B	H	L	Teileliste
FB1	Vt. spetsi				FUNDMENTHOLZER
F1	15,1m ²	28		3455	FUSSBODENBRETTER
PR	3	70	170	4900	DACHBALKEN
RB1	22,2m ²	20		4521	DACHBRETTER
R1	2	20	140	4940	<small>Vepte ketise kolcenirke</small> Traufenbretter
R2	2	45	65	4900	<small>Vepte ketise kolcenirke</small> Traufenbretter
R3	2	20	140	4720	<small>Vepte ketise kolcenirke</small> Giebelabschlussleiste
R4	2	20	90	4720	Giebelabschlussleiste
WN06	2	600	1770		<p>Sliding slats 30x30x1700 mm - 4 pcs.</p>
DR16	1	1588	1965		
P1	17m	20	40		Fußbodenleiste
P2	6+6	20	90	1945	Türleiste DR 16, Fensterleiste WN 06
P3	2+2	20	90	900	Fensterleiste WN 06
P4	2+2	20	90	540 570	Fensterleiste WN 06
P5	1+1	20	90	1890	Türleiste DR 16

Detailzeichnungen 870835

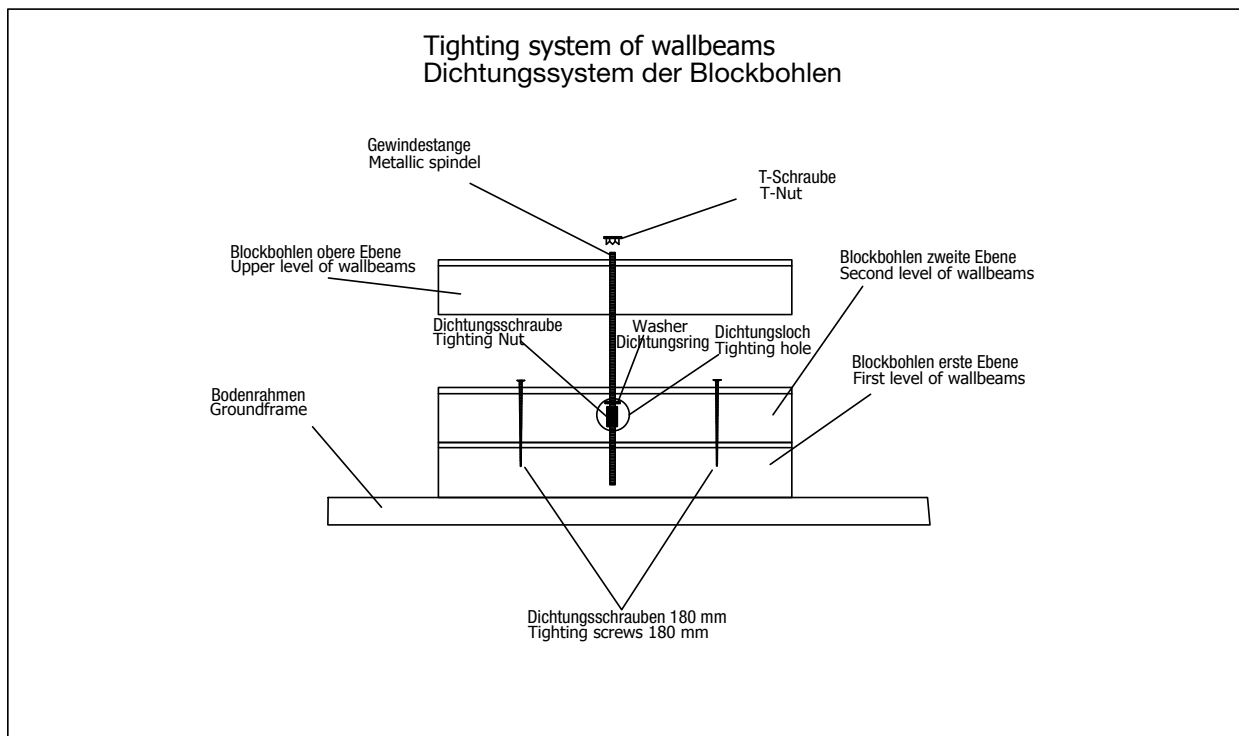
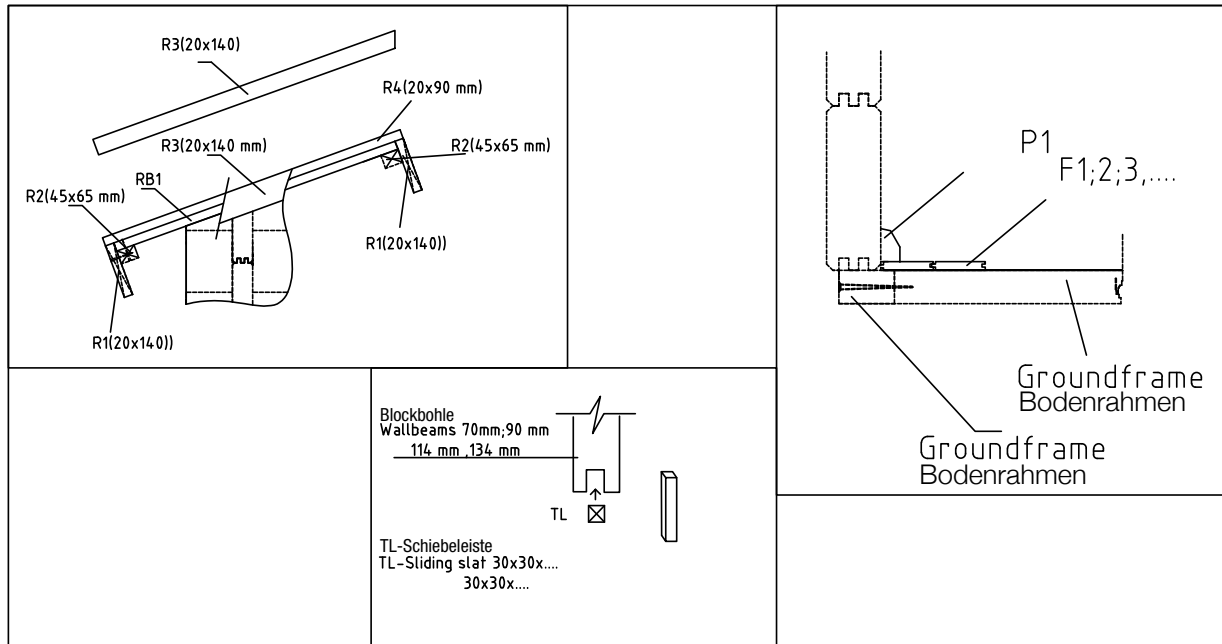

Wandplan 1 und 2 870835

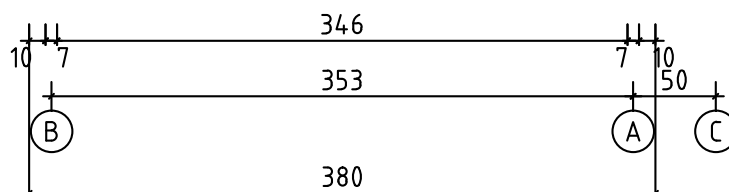
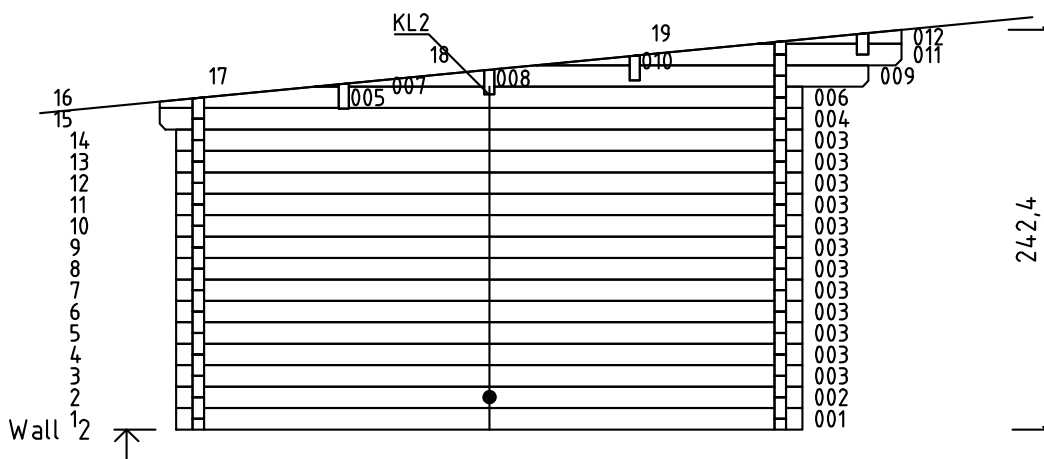
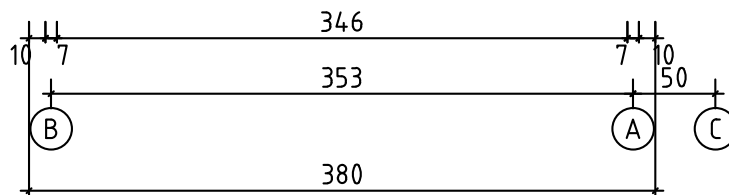
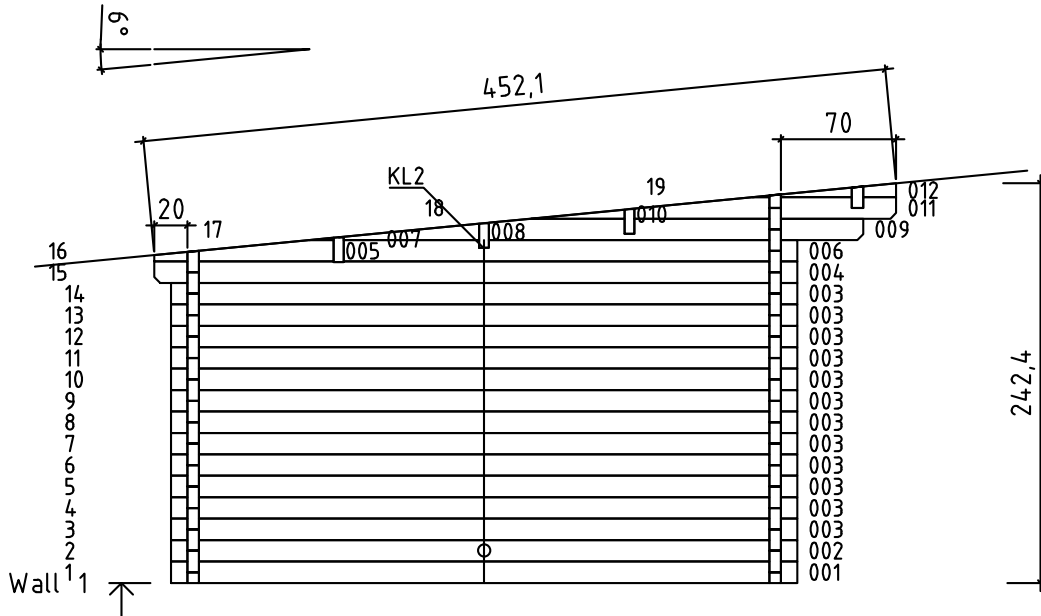

Wandplan A und B 870835

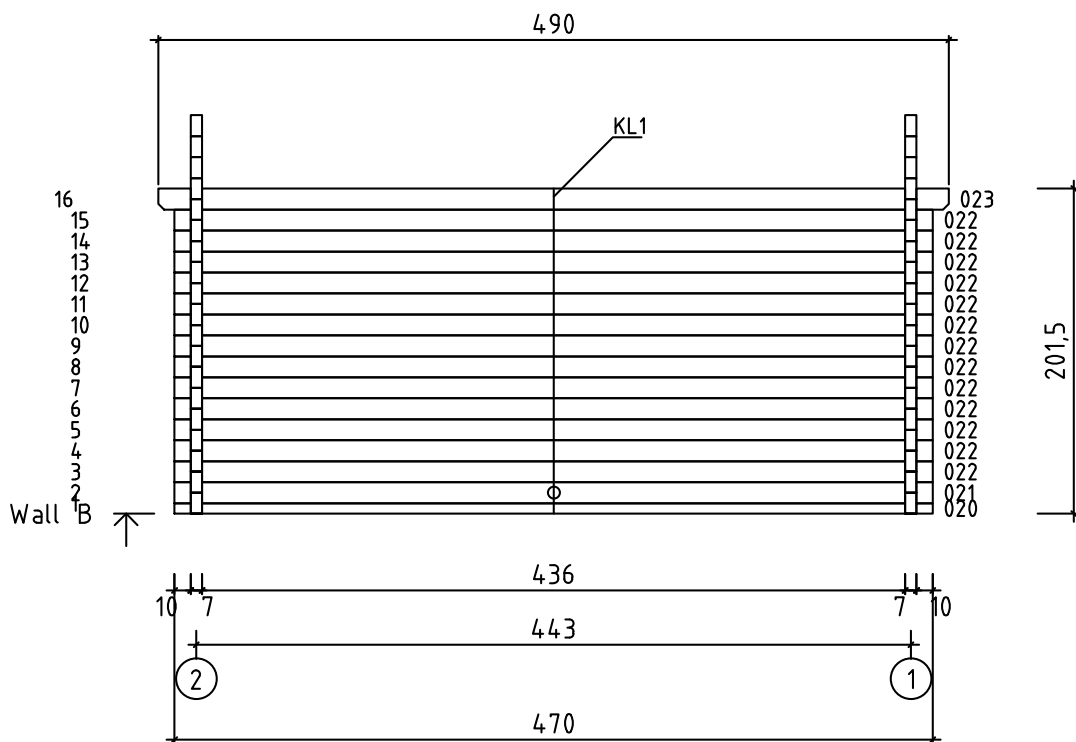
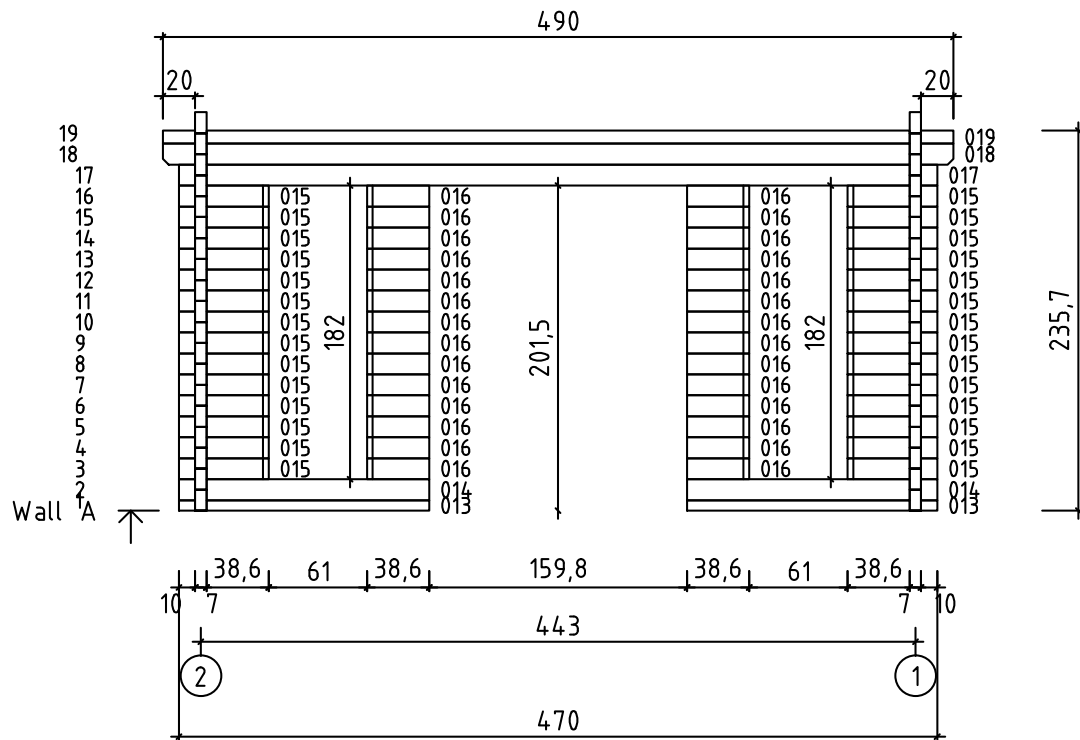

Wandplan C

870835

Vorgelagerte Vordachbohle vor Wand A

