

Technische Daten: Art.-Nr.: 870650

Wandaußenmaß: 530 x 530 cm

Bohlenstärke: 70 mm



Nordkap 70-G, durch Kunden farblich endbehandelt.

Kontrolliert durch:

Achtung: Alle angegebenen Maße sind ca.-Maße!

3D-Darstellung und Grundriss 870650

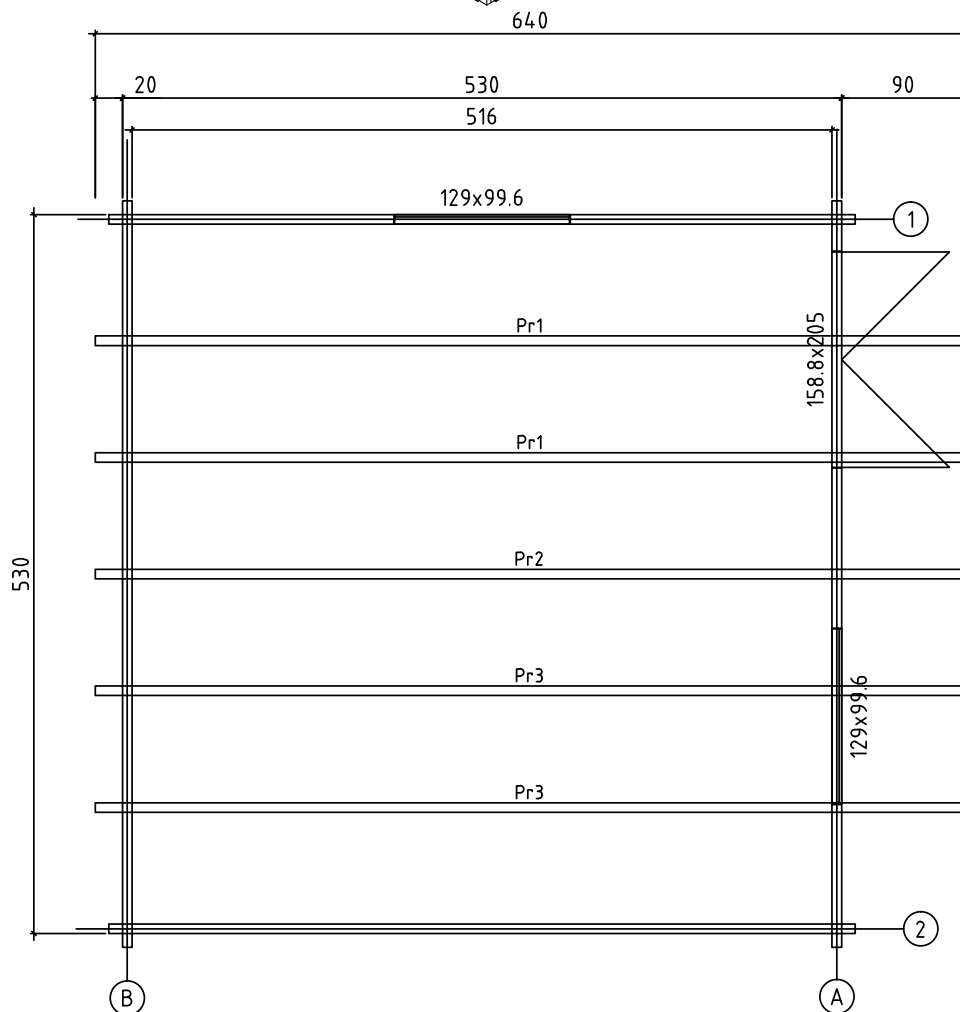
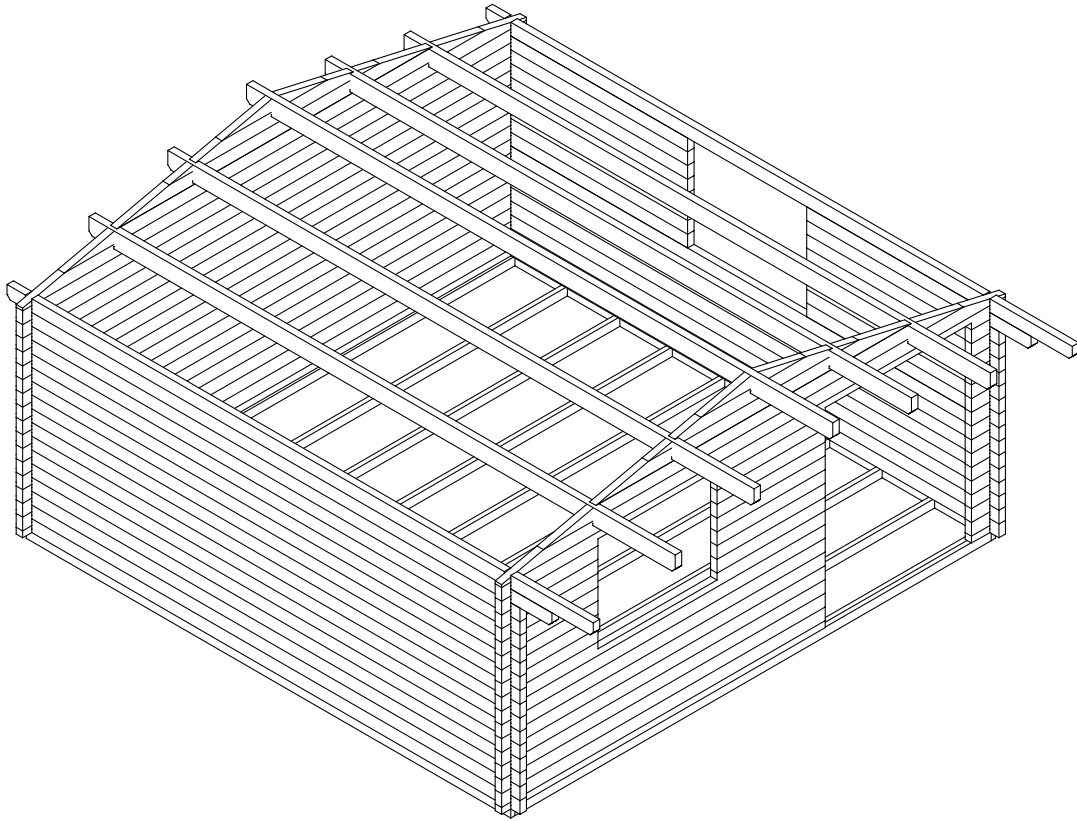





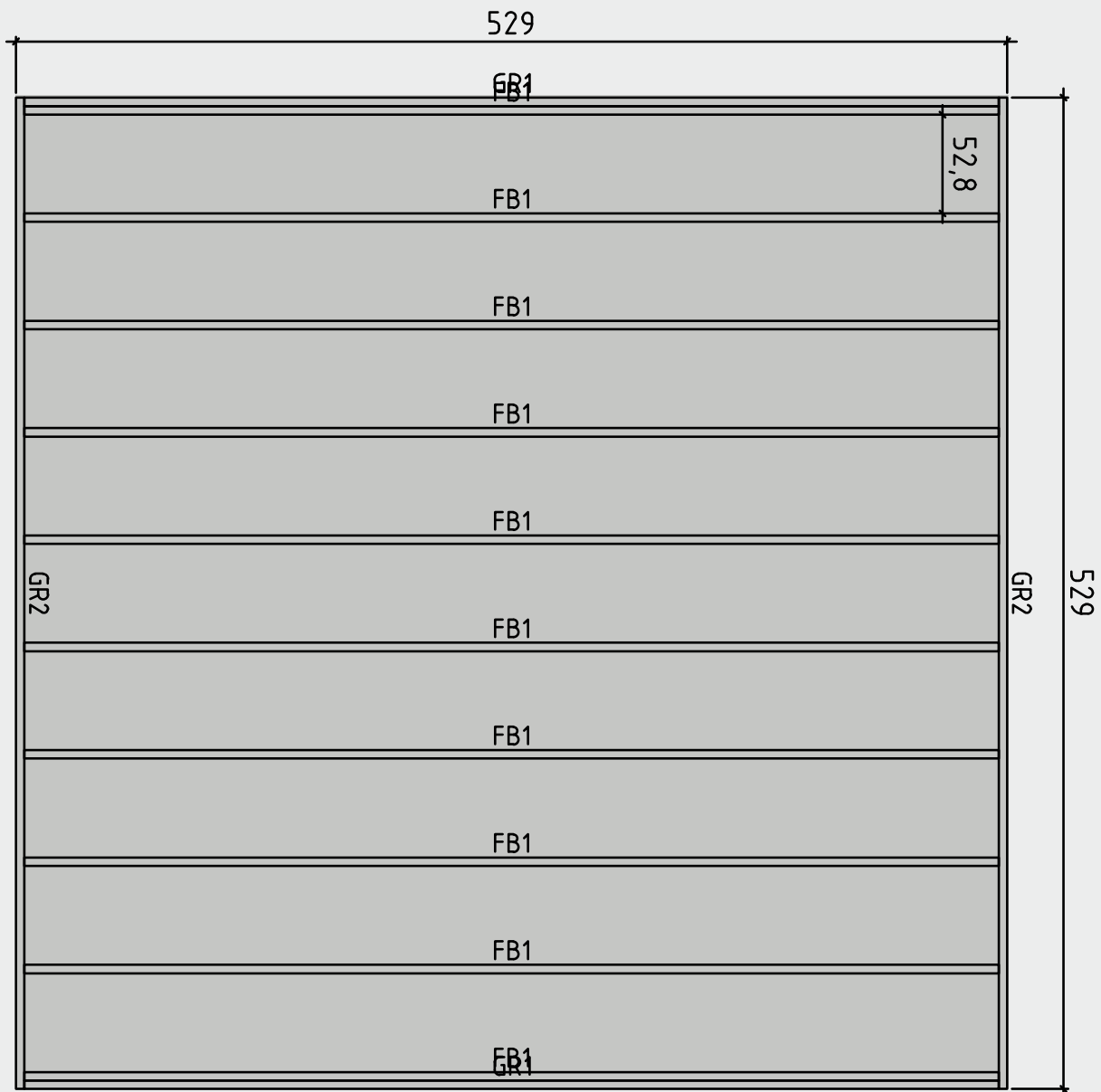





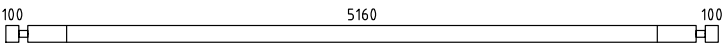
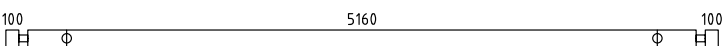
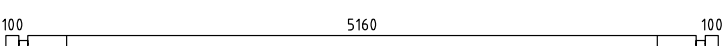
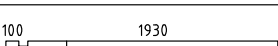
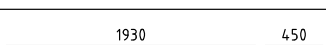
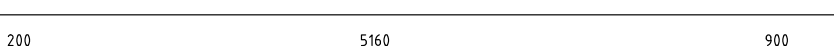
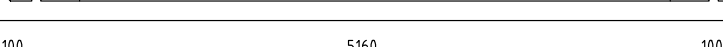
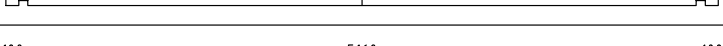
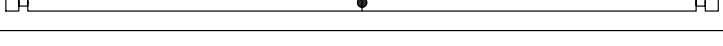
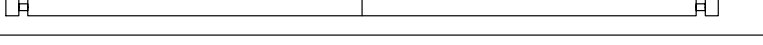
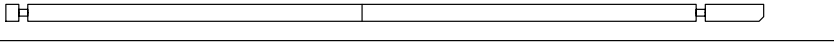
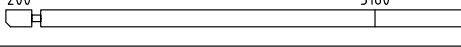

Lagerholzplan und Fundamentplan 870650

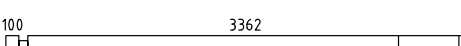
Wir empfehlen als Fundament für Ihr Gartenhaus eine vollflächig,
festgegründete gepflasterte oder betonierte Fläche.
Wahlweise ist auch ein Punkt- oder Streifenfundament möglich.

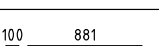

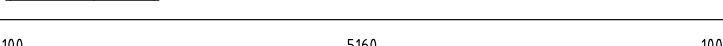

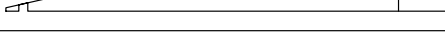







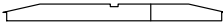

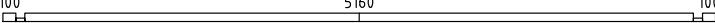
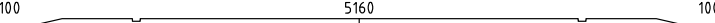
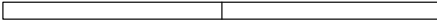

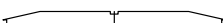
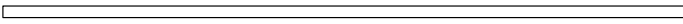
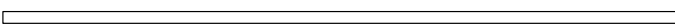
Teileliste 1

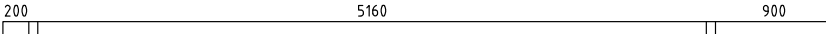
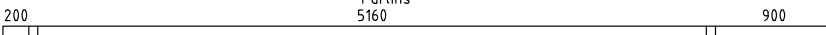
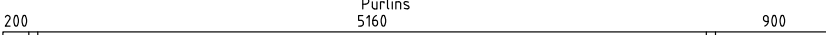
870650

Pos			Profil (mm)	Lenght (mm)
001		1	70x130	5500
002		1	70x130	5500
003		6	70x130	5500
004		15	70x130	2100
005		1	70x130	2450
006		1	70x130	6400
007		1	70x130	5500
008		2	70x130	5500
009		28	70x130	5500
010		1	70x130	5850
011		1	70x130	6400
012		1	70x65	3532
013		1	70x65	370
014		1	70x130	3532
015		15	70x130	370
016		6	70x130	3532
017		1	70x130	3532
018		7	70x130	1051
019		7	70x130	1181
020		1	70x130	5500
021		1	70x130	5500
022		7	70x123	543
023		1	70x130	3380
024		1	70x130	3440
025		4	70x58	257

Teileliste 2

870650

Pos			Profil (mm)	Lenght (mm)
026			70x130	1719
027			70x123	543
028			70x65	5500
029			70x130	5500
030			70x130	3380
031			70x130	3440
032			70x130	1719
GR2		GROUNDFRAME	45x90	5290
GR1		GROUNDFRAME	45x90	5200
FB1		FLOORBEAMS	45x90	5200
Pr1		Purlins 5160	70x170	6400
Pr2		Purlins 5160	70x170	6400
Pr3		Purlins 5160	70x170	6400
	WINDOW 1290x996			2
	DOOR 1588x2050			1
1	Screws/Schrauben/Vis 5x100 mm- For fixing first row of wall logs /Fixierung des ersten Bohlenkranzes/Pour fixer les lames de plancher			6
2	Nails/Nägel/Clous 2.1x50 - For fixing floorboards/ Befestigung Fussbodenbretter/Pour fixer les lames de plancher			495
3	Nails/Nägel/Clous 2.1x50 - For fixing roofboards/ Befestigung Dachbretter/Pour fixer les voliges			550
4	Nails/Nägel/Clous 2.1x50 - For fixing floor edge trims/ Befestigung Fussleisten/Pour fixer les plinthes du plancher			30
5	Nails/Nägel/Clous 2.1x50 - For fixing roofing felt fillet/ Befestigung giebelabschlussbrett/Pour fixer la latte de finition de la couverture			20
6	Screws/Schrauben/Vis 3,5x50 mm- For fixing roof side boards and roof edge reinforcement Befestigung Traufenbretter und Traufenleisten Pour fixer les planches de rive et le tasseau de refront			44
7	Screws/Schrauben/Vis 3,5x50 mm- For fixing fascia boards and diamonds/ Befestigung Giebelblende und Raute Pour fixer les planches de rive et le diamant			28
8	Screws/Schrauben/Vis 3,5x50 mm- For fixing fwindow and door trims/ Befestigung Fenster und türen/ Pour fixer les croisillons des fenetres et des portes			68















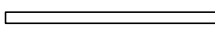

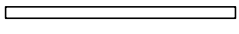

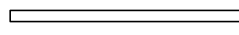

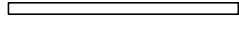
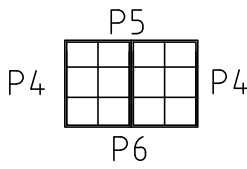
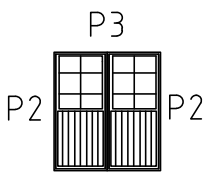
Teileliste 3

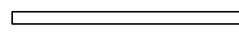
870650

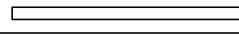
Pos		Profil (mm)	Length (mm)
9	Metal storm Brace/Gewindestange/Tige filetee 10 mm 	5	
10	Shim,Nuts/Mutter ,U-Scheibe/Ecrou;Rondelle 10 mm For fixing storm braces/ Pour fixer les anti tempete/ Für Sturmleisten Pour fixer les croisillons des fenetres et des portes Metal storm Brace/Gewindestange/Tige filetee 10 mm  KL1 M10 <i>2,77 m 1</i> Screws 180 <i>10</i> pcs. KL2 M10 <i>2,89 m 1</i> Plastic caps 5 pcs. KL3 M10 2,31 m 3	5/5	

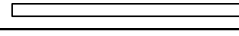
Teileliste 4

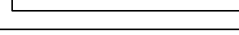
870650

POS	ST.	B	H	L	ERKLÄRUNG
FB1	Vt. spetsi				 FLOORBEAMS
F1	26,62m ²	28		5155	 FUSSBODENBRETTER 55/42/35
PR	5	70	170	6400	 ROOFBEAMS
RB1	38,1m ²	20		2975	 Dachbretter 138/108/88
R1	4	20	120	3200	<i>Vaata katuse kaldenurka</i>  Frontboard 
R2	4	45	65	3200	<i>Vaata katuse kaldenurka</i>  Frontboard fixing board 
R3	4	20	120	3200	<i>Vaata katuse kaldenurka</i>  Girders facade 
R4	4	20	90	3200	 Topboard 
WN29	2	1290	996		
DR15	1	1588	2050		 Sliding slats 30x30x1900 mm - 2 pcs. 30x30x800 mm - 2 pcs.
P1	22 m	20	40		 Floor edge trim
P2	2+2	20	90	2030	 Türleiste DR15 
P3	1+1	20	90	1890	 Türleiste DR15 
P4	4+4	20	90	1100	 Fensterleiste WN29 
P5	2+2	20	90	1590	 Fensterleiste WN29 
P6	2+2	20	90	1250	 Fensterleiste WN29 

Detailzeichnungen 870650

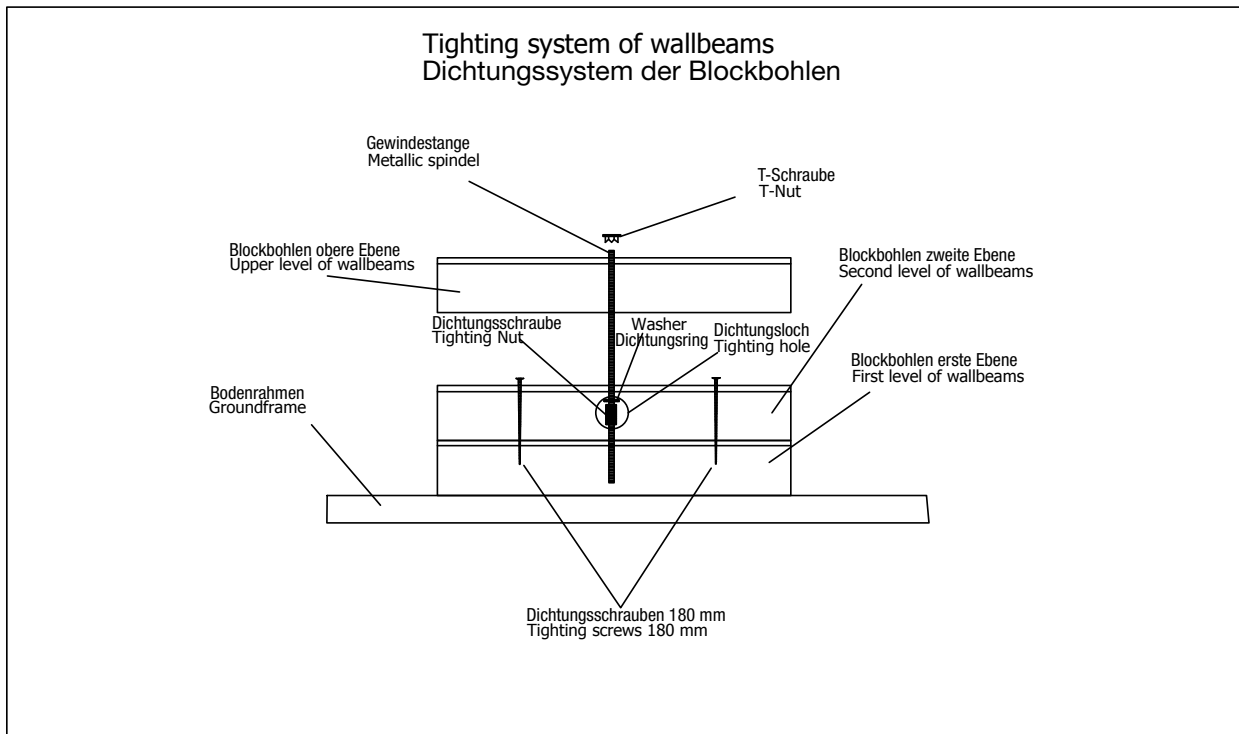
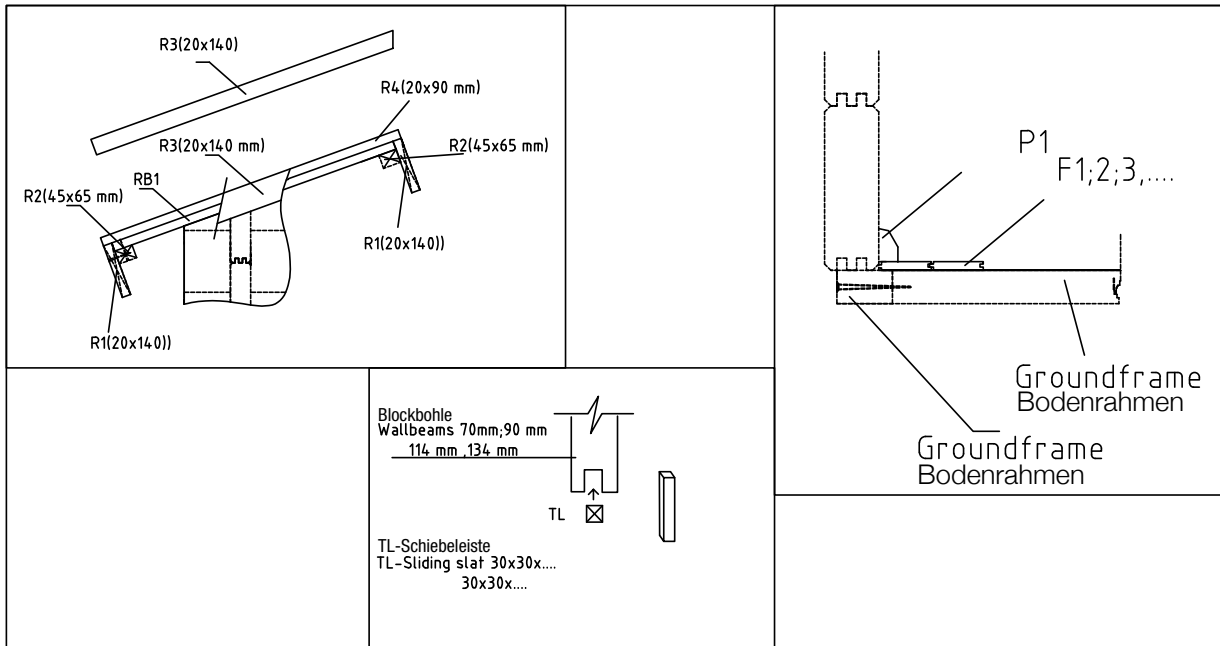

Wandplan 1 und 2 870650

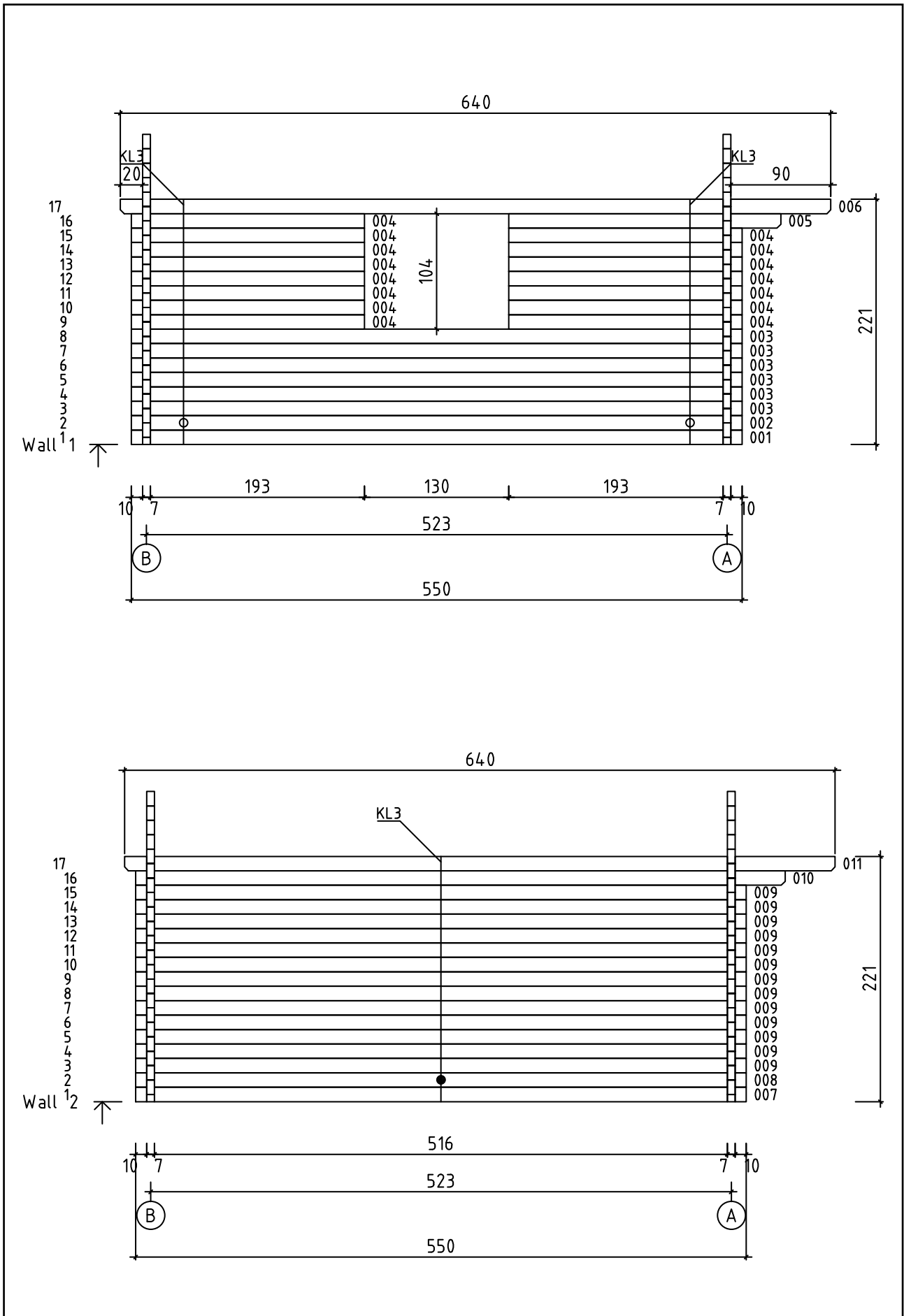

Wandplan A und B 870650

