

Technische Daten: Art.-Nr.: 870620

Wandaußenmaß: 390 x 390 cm

Bohlenstärke: 70 mm



Nordkap 70-C, durch Kunden farblich endbehandelt.

Kontrolliert durch:

Achtung: Alle angegebenen Maße sind ca.-Maße!

3D-Darstellung und Grundriss 870620

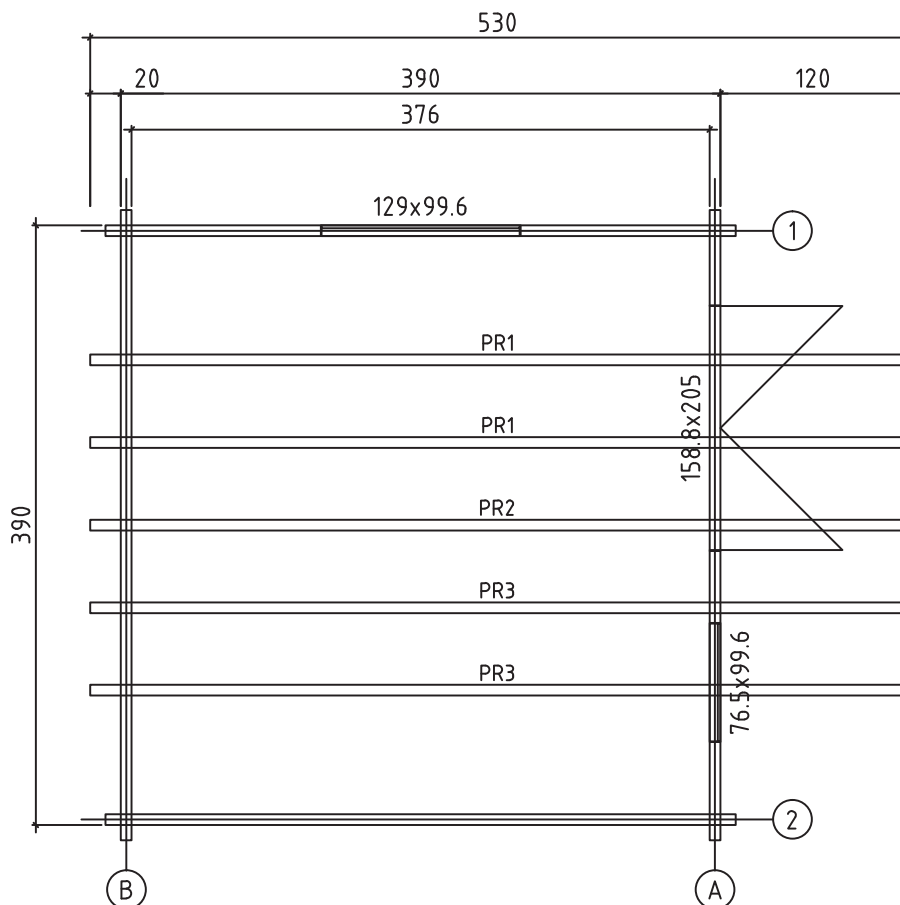
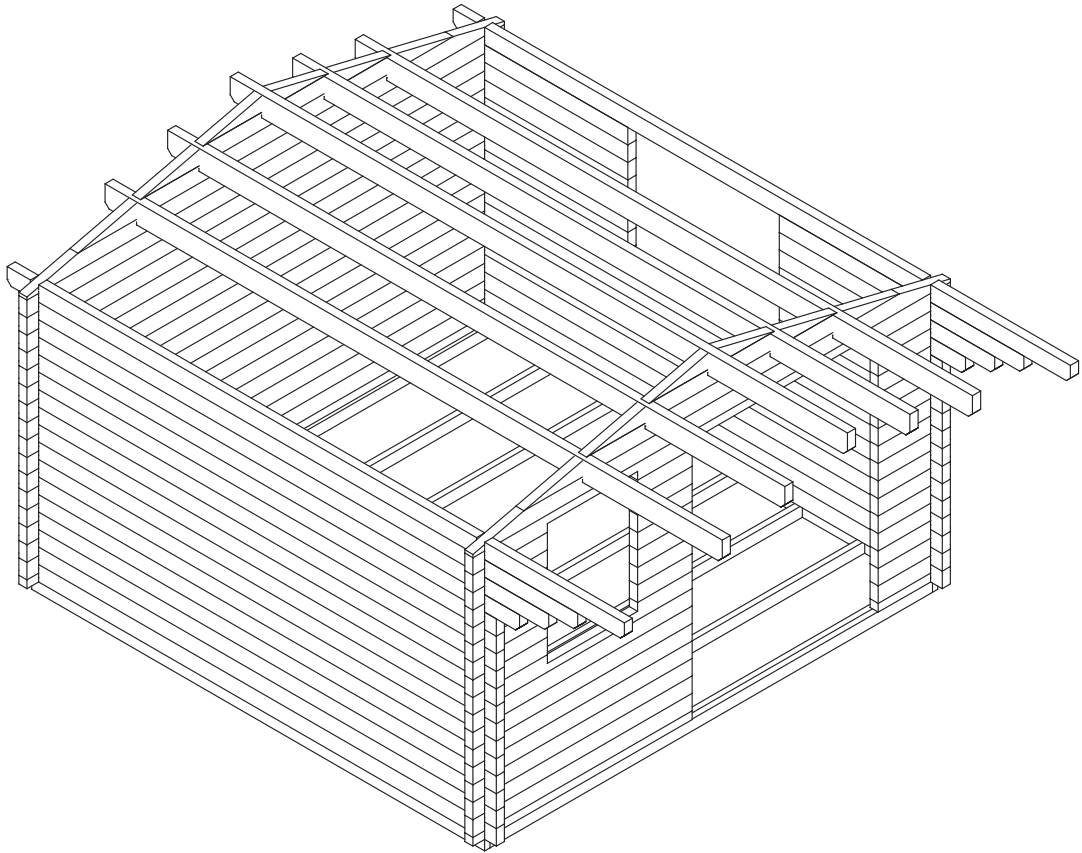





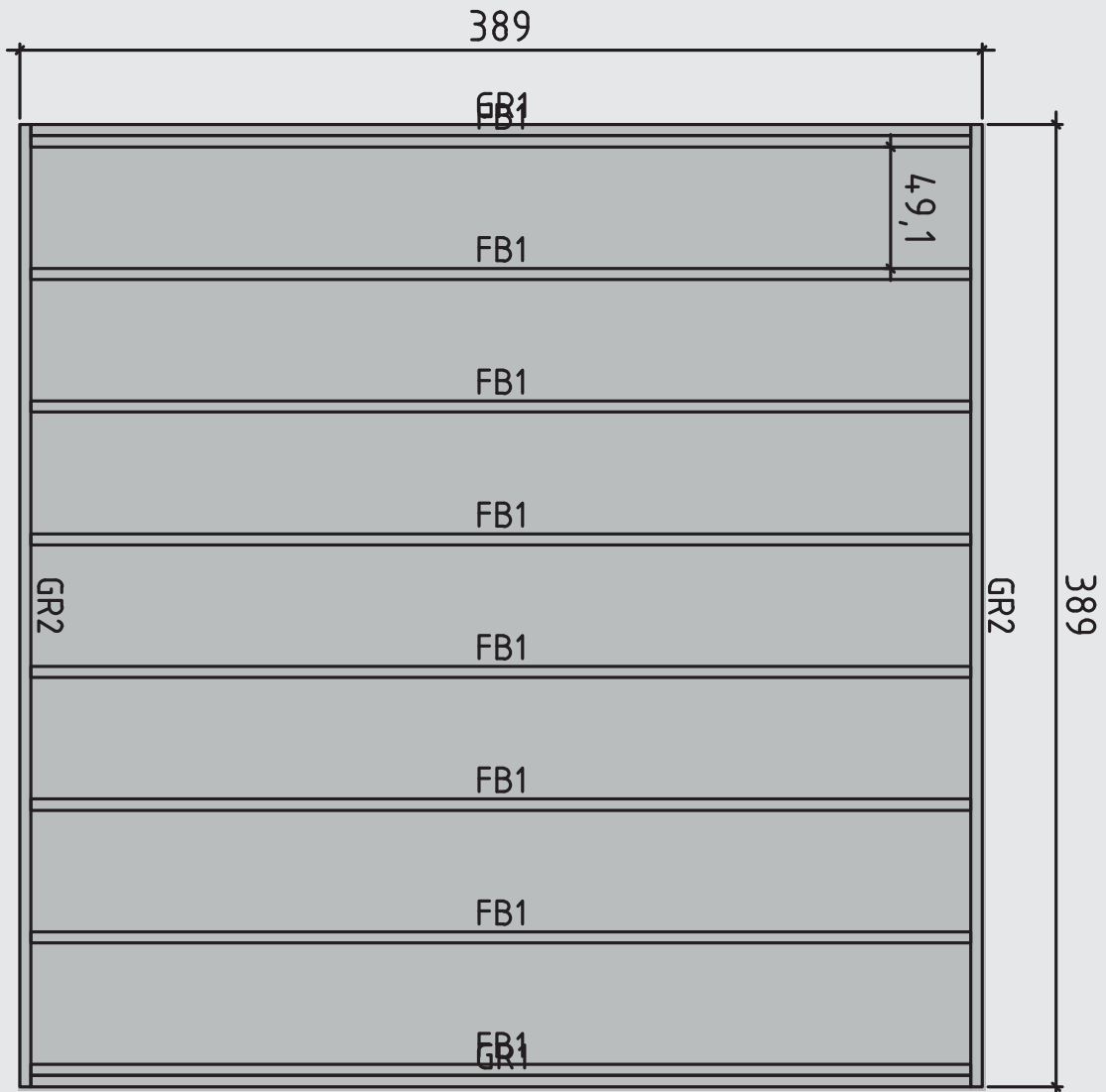

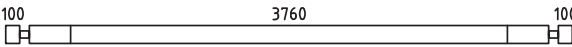
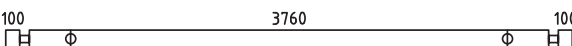
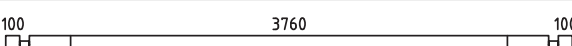
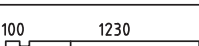
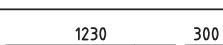
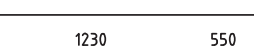
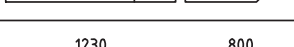
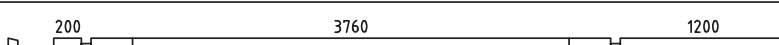
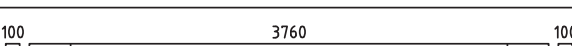
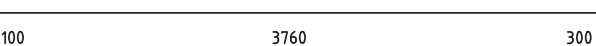
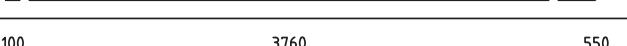
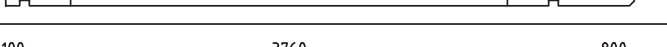
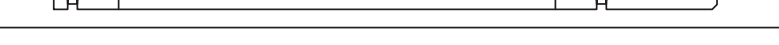
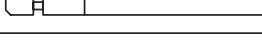

Lagerholzplan und Fundamentplan 870620

Wir empfehlen als Fundament für Ihr Gartenhaus eine vollflächig,
festgegründete gepflasterte oder betonierte Fläche.
Wahlweise ist auch ein Punkt- oder Streifenfundament möglich.



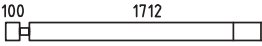

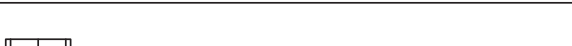
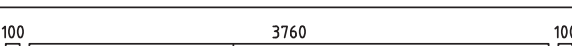









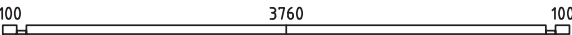
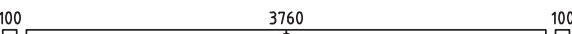
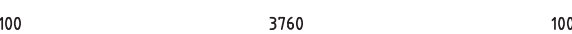
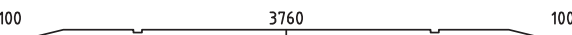

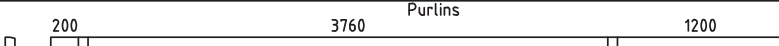
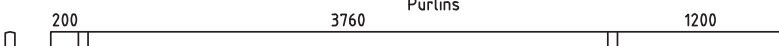
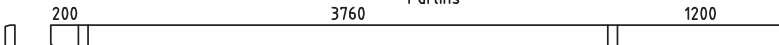

Teileliste 1

870620

Pos			Profil (mm)	Lenght (mm)
001		2	70x130	4100
002		1	70x130	4100
003		17	70x130	4100
004		13	70x130	1400
005		1	70x130	1600
006		1	70x130	1850
007		1	70x130	2100
008		1	70x130	5300
009		1	70x130	4100
010		1	70x130	4300
011		1	70x130	4550
012		1	70x130	4800
013		1	70x130	5300
014		1	70x65	1882
015		1	70x65	620
016		1	70x130	1882
017		15	70x130	620
018		6	70x130	1882
019		1	70x130	1882
020		7	70x130	638
021		7	70x130	469
022		1	70x130	4100
023		1	70x130	4100
024		11	70x123	507
025		1	70x130	2089



Teileliste 2

870620

Pos			Profil (mm)	Lenght (mm)
026			70x130	1014
027			70x123	507
028			70x65	4100
029			70x130	4100
030			70x130	4100
031			70x130	4100
032			70x130	2089
033			70x130	1014
GR2		GROUNDFRAME	45x90	3890
GR1		GROUNDFRAME	45x90	3800
FB1		FLOORBEAMS	45x90	3800
PR1		Purlins	70x170	5300
PR2		Purlins	70x170	5300
PR3		Purlins	70x170	5300
	WINDOW 1290x996			1
	WINDOW 765x996			1
	DOOR 1588x2050			1
1	Screws/Schrauben/Vis 5x100 mm- For fixing first row of wall logs /Fixierung des ersten Bohlenkranzes/Pour fixer les lamesde plancher			6
2	Nails/Nägel/Clous 2.5x50 - For fixing floorboards/ Befestigung Fussbodenbretter/Pour fixer les lames de plancher			360
3	Nails/Nägel/Clous 2.5x50 - For fixing roofboards/ Befestigung Dachbretter/Pour fixer les voliges			500
4	Nails/Nägel/Clous 2.5x50 - For fixing floor edge trims/ Befestigung Fussleisten/Pour fixer les plinthes du plancher			30
5	Nails/Nägel/Clous 2.5x50 - For fixing roofing felt fillet/ Befestigung giebelabschlussbrett/Pour fixer la latte de finition de la couverture			20
6	Screws/Schrauben/Vis 2,5x50 mm- For fixing roof side boards and roof edge reinforcement Befestigung Traufenbretter und Traufenleisten Pour fixer les planches de rive et le tasseau de refront			44
7	Screws/Schrauben/Vis 2,5x50 mm- For fixing fascia boards and diamonds/ Befestigung Giebelblende und Raute Pour fixer les planches de rive et le diamant			28















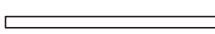



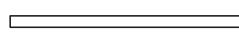

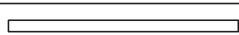
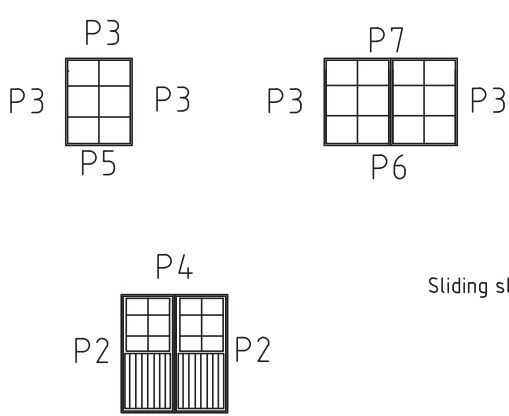

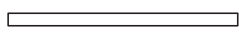
Teileliste 3

870620

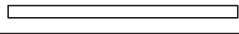
Pos			Profil (mm)	Lenght (mm)
8	<p>Screws/Schrauben/Vis 2,5x50 mm- For fixing fwindow and door trims/ Befestigung Fenster und türen/ Pour fixer les croisillons des fenetres et des portes</p> 		44	
9	<p>Metal storm Brace/Gewindestange/Tige filetee 10 mm</p> 		5	
10	<p>Shim,Nuts/Mutter ,U-Scheibe/Ecrou;Rondelle 10 mm For fixing storm braces/ Pour fixer les anti tempete/ Für Sturmleisten Pour fixer les croisillons des fenetres et des portes</p>  <p>Metal storm Brace/Gewindestange/Tige filetee 10 mm KL1 M10 2,31 4 Plastic caps 6 pcs, KL2 M10 2,64 1 Screws 180 12 pcs. KL3 M10 2,76 1</p>		6/6	

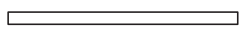
Teileliste 4

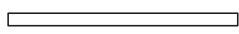
870620

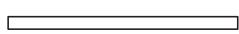
POS	ST.	B	H	L	ERKLÄRUNG
FB1	Vt. spetsi				 Fundamentholzer
F1	14,13 m ²	28		3755	 Fussbodenbretter 45/34/28
PR	5	70	170	5300	 Dachbalken
RB1	24m ²	20		2265	 Dachbretter 125/95/73
R1	2	20	120	5300	<i>Vaata katuse kaldenurka</i>  Traufenbretttert 
R2	2	45	65	5300	<i>Vaata katuse kaldenurka</i>  Traufenbretter 
R3	4	20	120	2500	<i>Vaata katuse kaldenurka</i>  Giebelblende 
R4	4	20	90	2500	 Giebelblende 
WN07	1	765	996		 <p>Sliding stats 30x30x1900 mm - 2 pcs. 30x30x800 mm - 2 pcs.</p>
WN13	1	1290	996		
DR16	1	1588	2050		
P1	16m	20	40		 Fussbodenleiste
P2	2+2	20	90	2030	 Türleiste DR16 
P3	10	20	90	1100	 Fensterleiste WN13; WN07 
P4	1+1	20	90	1890	 Türleiste DR16 
P5	1+1	20	90	725	 Fensterleiste WN07 
P6	1+1	20	90	1250	 Fensterleiste WN13 
P7	1+1	20	90	1590	 Fensterleiste WN13 

Detailzeichnungen 870620

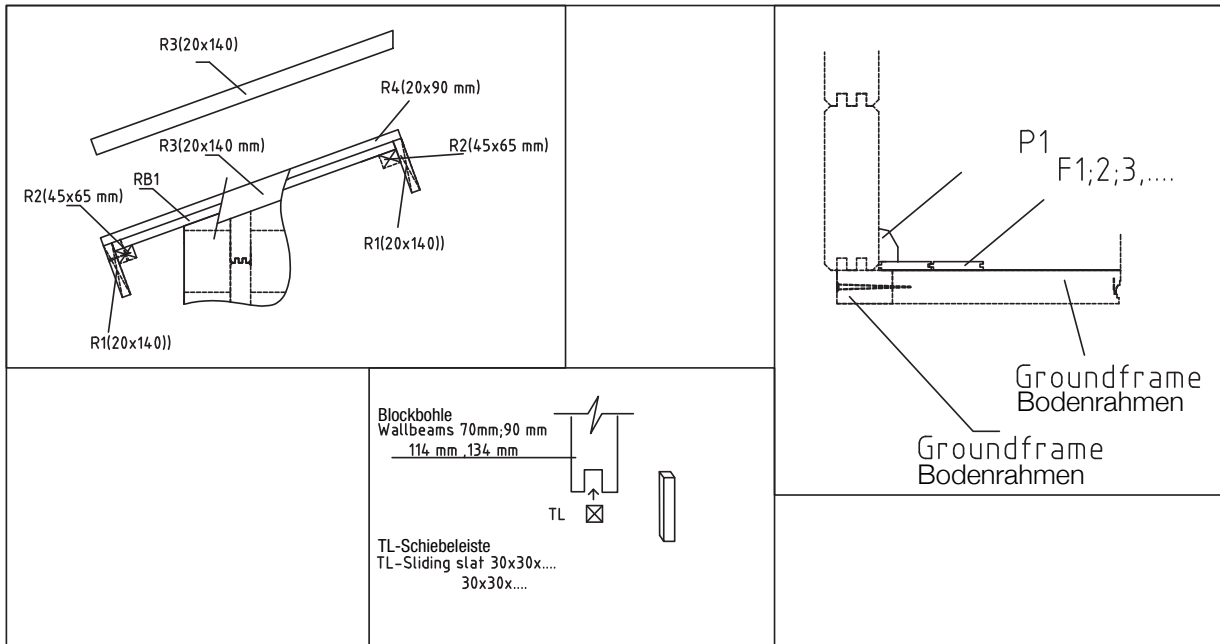

Tighting system of wallbeams Dichtungssystem der Blockbohlen

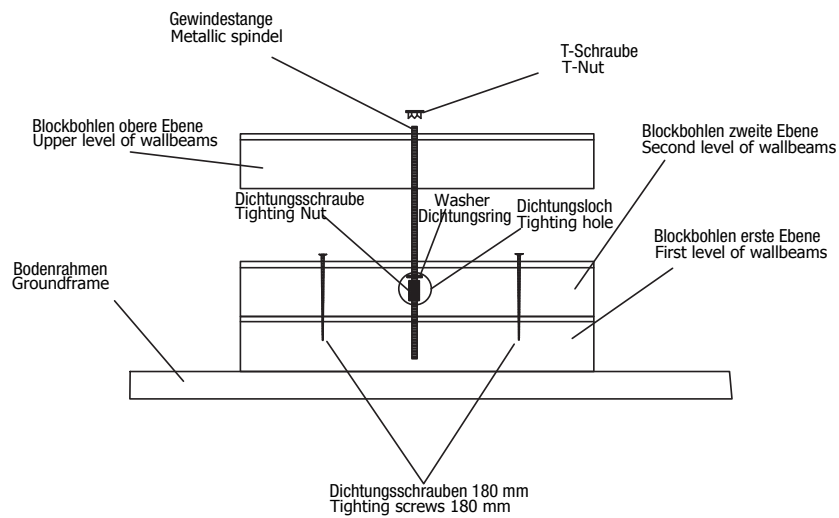

Wandplan 1 und 2 870620

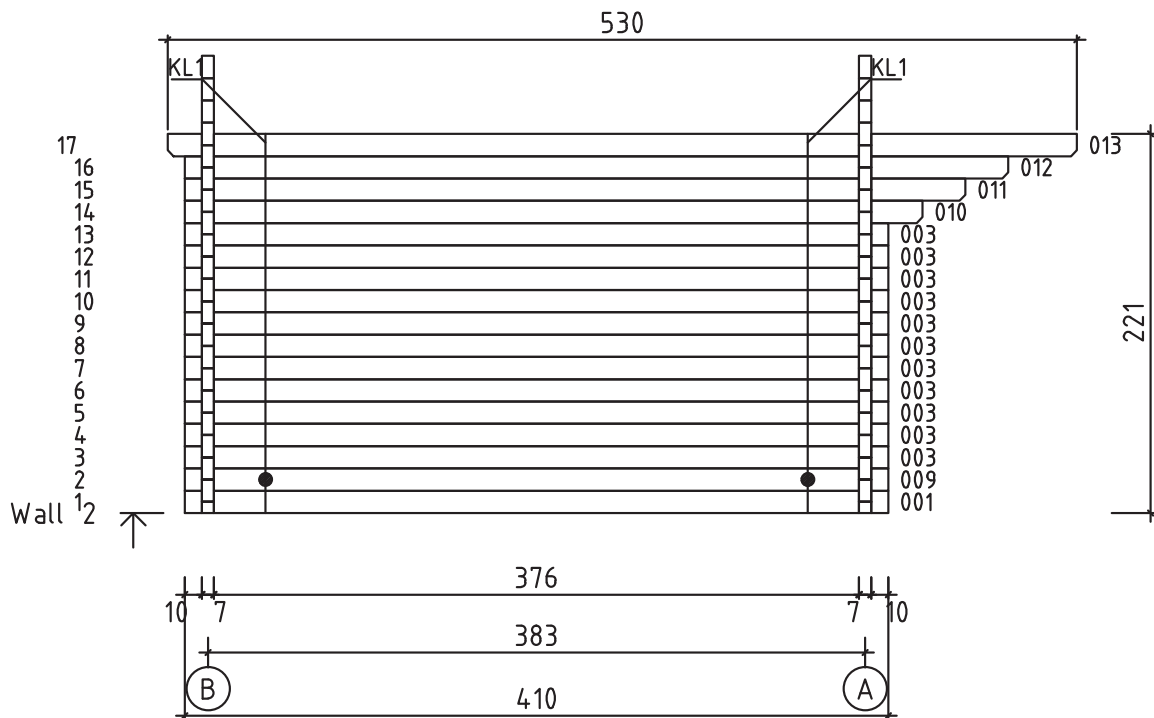
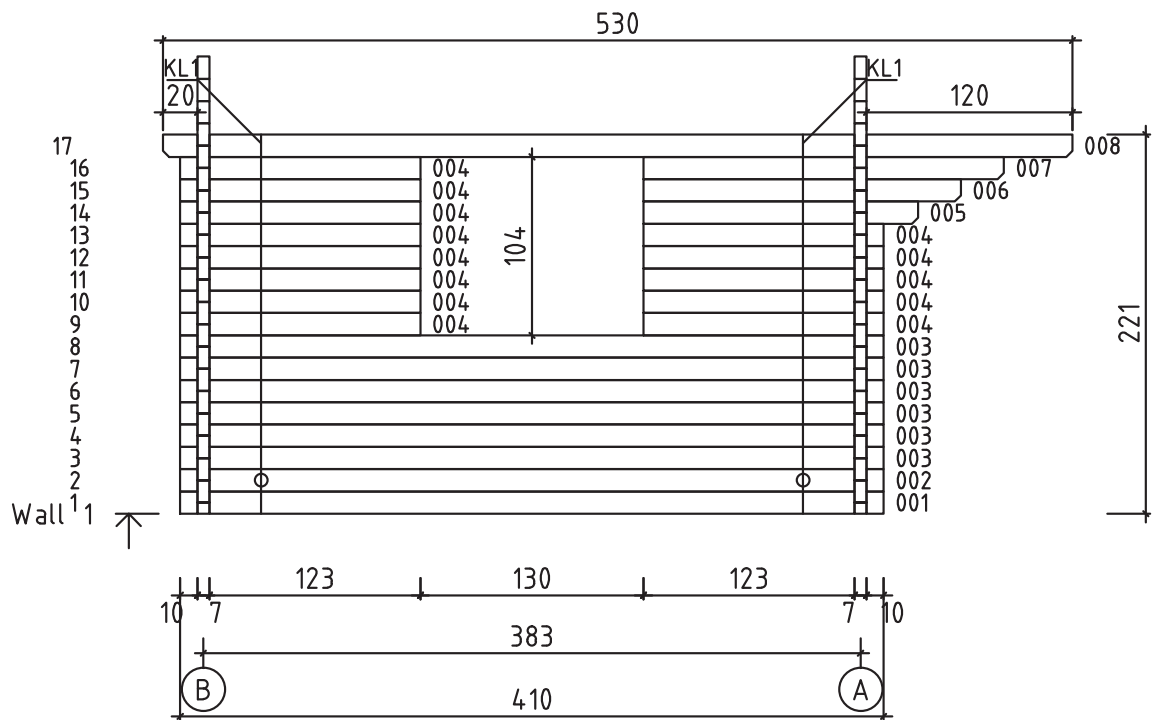

Wandplan A und B

870620

