

Technische Daten: Art.-Nr.: 870510

Wandaußenmaß: 360 x 360 cm

Bohlenstärke: 70 mm



Durch Kunden farblich endbehandelt

Kontrolliert durch:

Achtung: Alle angegebenen Maße sind ca.-Maße!

3D-Darstellung und Grundriss 870510

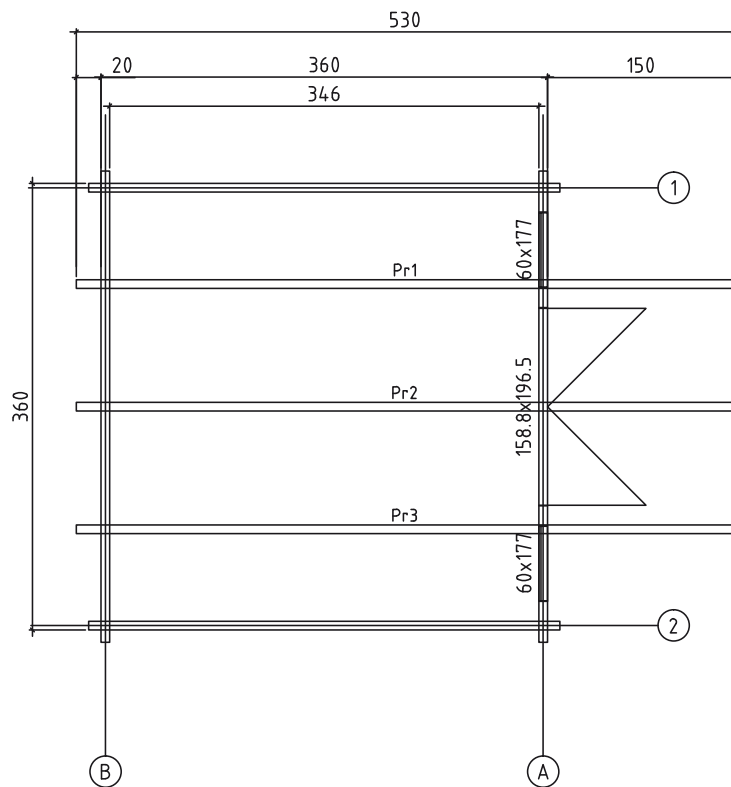
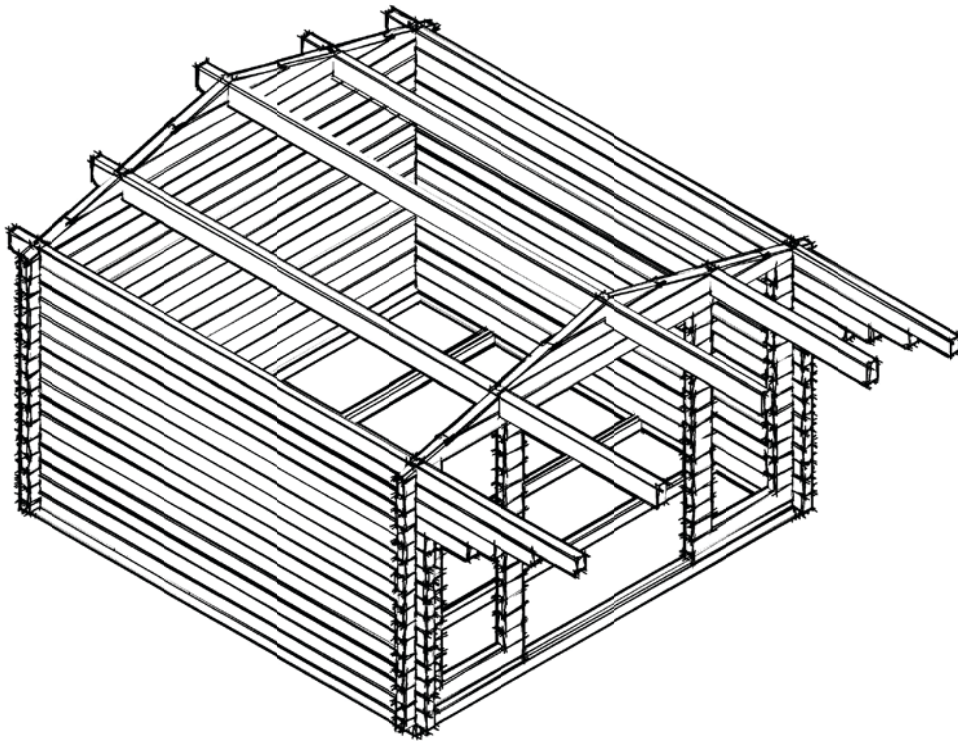





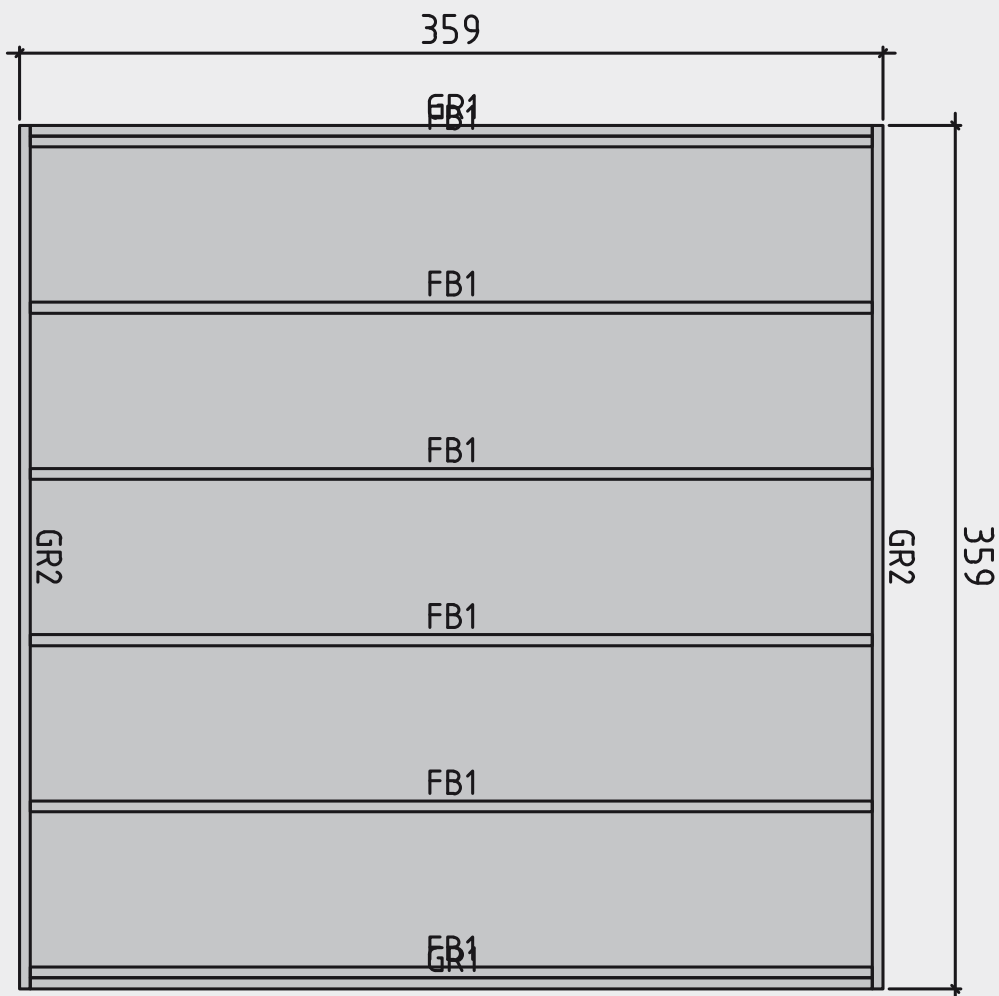









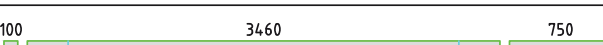



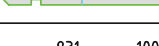



Lagerholzplan und Fundamentplan 870510

Wir empfehlen als Fundament für Ihr Gartenhaus eine vollflächig,
festgegründete gepflasterte oder betonierte Fläche.
Wahlweise ist auch ein Punkt- oder Streifenfundament möglich.







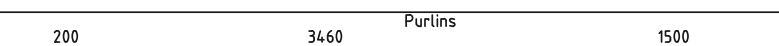
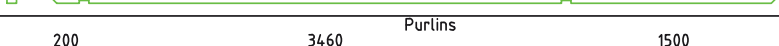





Teileliste 1

870510

Pos		Anz.	Profile (mm)	Länge
001		2	70x130	3800
002		2	70x130	3800
003		20	70x130	3800
004		2	70x130	4200
005		2	70x130	4450
006		2	70x130	4800
007		1	70x130	5300
008		1	70x130	5300
009		2	70x65	1101
010		2	70x130	1101
011		28	70x130	331
012		28	70x130	160
013		2	70x130	3800
014		8	70x122	464
015		2	70x130	1917
016		2	70x130	1977
017		1	70x65	3800
018		15	70x130	3800
GR2	GROUNDFRAME 	2	45x90	3590
GR1	GROUNDFRAME 	2	45x90	3500
FB1	FLOORBEAMS 	6	45x90	3500
Pr1	Purlins 	1	70x170	5300
Pr2	Purlins 	1	70x170	5300
Pr3	Purlins 	1	70x170	5300
	WINDOW 600x1770	2		











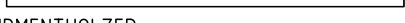





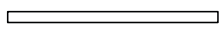

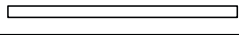

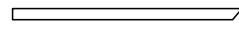
Teileliste 2

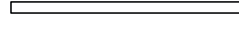
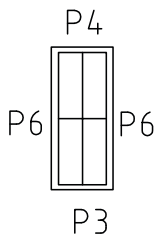
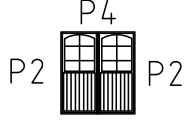
870510

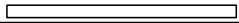
Pos		Anz.	Profile (mm)	Länge
	D00R 1588x1965	1		
1	Screws/Schrauben/Vis 5x100 mm- For fixing first row of wall logs /Fixierung des ersten Bohlenkranzes/Pour fixer les lames de plancher		6	
2	Nails/Nägel/Clous 2.5x50 - For fixing floorboards/ Befestigung Fussbodenbretter/Pour fixer les lames de plancher		280	
3	Nails/Nägel/Clous 2.5x50 - For fixing roofboards/ Befestigung Dachbretter/Pour fixer les voliges		370	
4	Nails/Nägel/Clous 2.5x50 - For fixing floor edge trims/ Befestigung Fussleisten/Pour fixer les plinthes du plancher		30	
5	Nails/Nägel/Clous 2.5x50 - For fixing roofing felt fillet/ Befestigung giebelabschlussbrett/Pour fixer la latte de finition de la couverture		20	
6	Screws/Schrauben/Vis 2,5x50 mm- For fixing roof side boards and roof edge reinforcement Befestigung Traufenbretter und Traufenleisten Pour fixer les planches de rive et le tasseau de refront		44	
7	Screws/Schrauben/Vis 2,5x50 mm- For fixing fascia boards and diamonds/ Befestigung Giebelblende und Raute Pour fixer les planches de rive et le diamant		28	
8	Screws/Schrauben/Vis 2,5x50 mm- For fixing fwindow and door trims/ Befestigung Fenster und türen/ Pour fixer les croisillons des fenetres et des portes		44	
9	Metal storm Brace/Gewindestange/Tige filetee 10 mm		5	
10	Shim;Nuts/Mutter ,U-Scheibe/Ecrou;Rondelle 10 mm For fixing storm braces/ Pour fixer les anti tempete/ Für Sturmleisten Pour fixer les croisillons des fenetres et des portes Metal storm Brace/Gewindestange/Tige filetee 10 mm KL1 M10 2,63 m 1 Screws 180 10 pcs. KL2 M10 2,51 m 1 Plastic caps 5 pcs.		5 / 5	

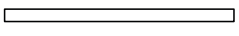
Teileliste 3

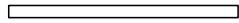
870510

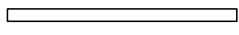
Specification for Hammerfest 70 B 70x130 mm					Teileliste		
POS	ST.	B	H	L			
FB1	Vt. spetsi					FUNDMENTHOLZER	
F2	12 m ²	28		3455		FUSSBODENBRETTER	40/31/26
R1	3	70	170	5300		DACHBALKEN	
R2	22,5 m ²	20		2120		DACHBRETTER	122/94/78
R3	2	20	120	5300	<small>Vaete kalluse kalcenturke</small> 	Traufenbretter	
R4	2	45	65	5300	<small>Vaete kalluse kalcenturke</small> 	Traufenbretter	
R5	4	20	120	2300	<small>Vaete kalluse kalcenturke</small> 	Giebelabschlussleiste	
R6	4	20	90	2300		Giebelabschlussleiste	
WN07	1	600	1770		 <p>Sliding slats 30x30x1650 mm - 4 pcs.</p>		
DR16	1	1588	1965				
P1	20 m	20	40			Fussbodenleiste	
P2	4	20	90	1945		Türleiste DR 16	
P3	2+2	20	90	570 540		Türleiste und Fensterleiste DR 16; WN 07	
P4	2	20	90	3340		Türleiste DR 16	
P6	8	20	90	1880		Fensterleiste WN07	

Wandplan 1 und 2 870510

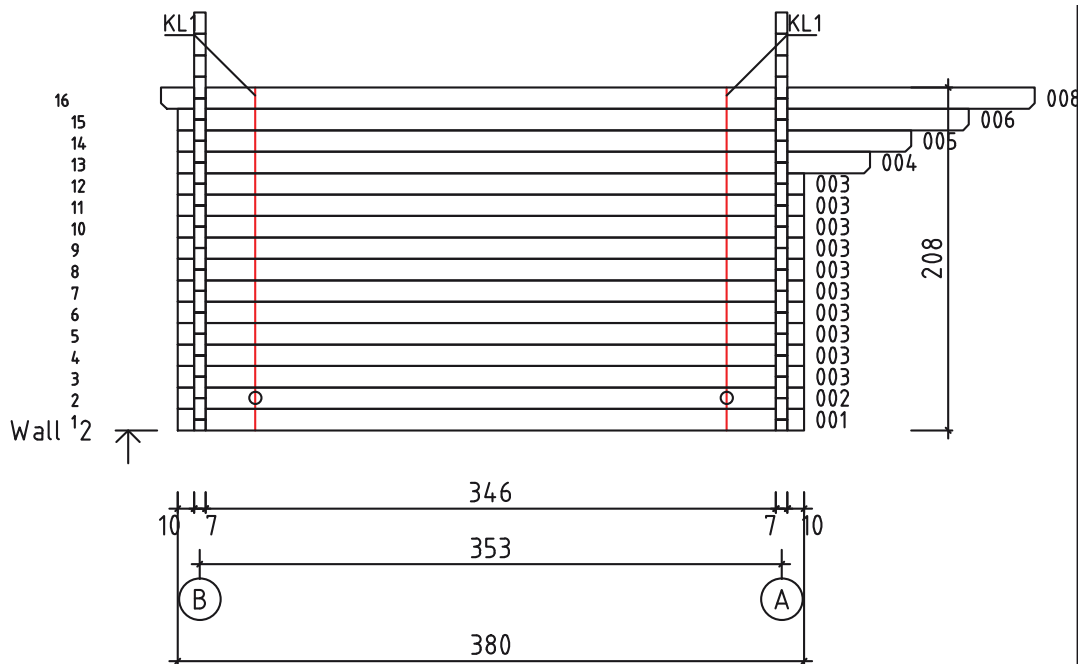
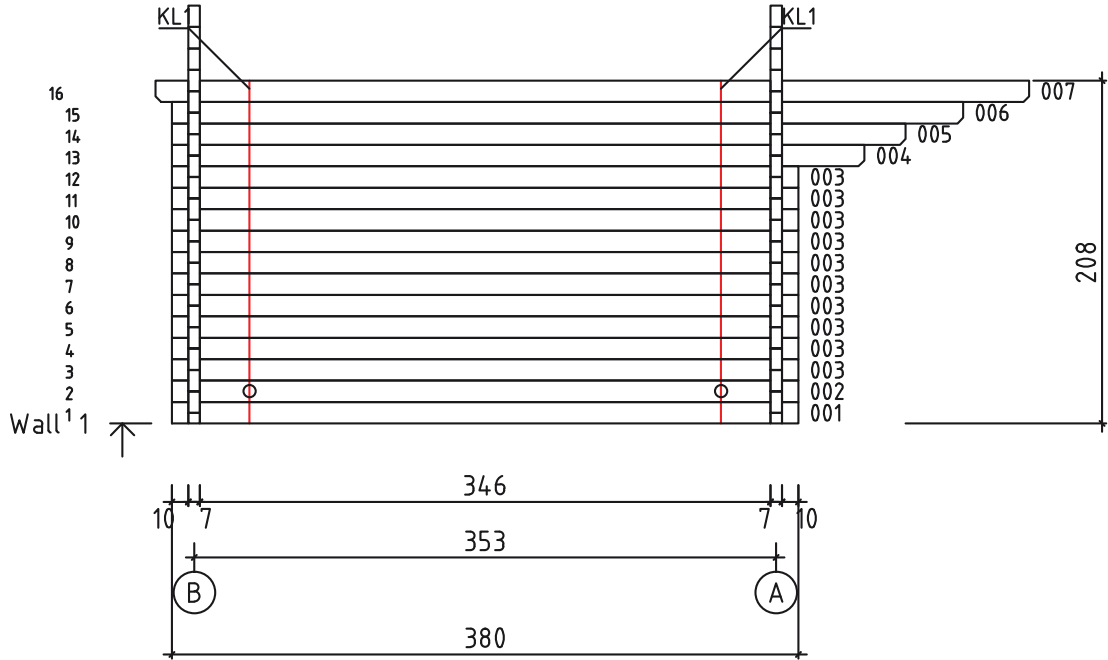

Wandplan A 870510

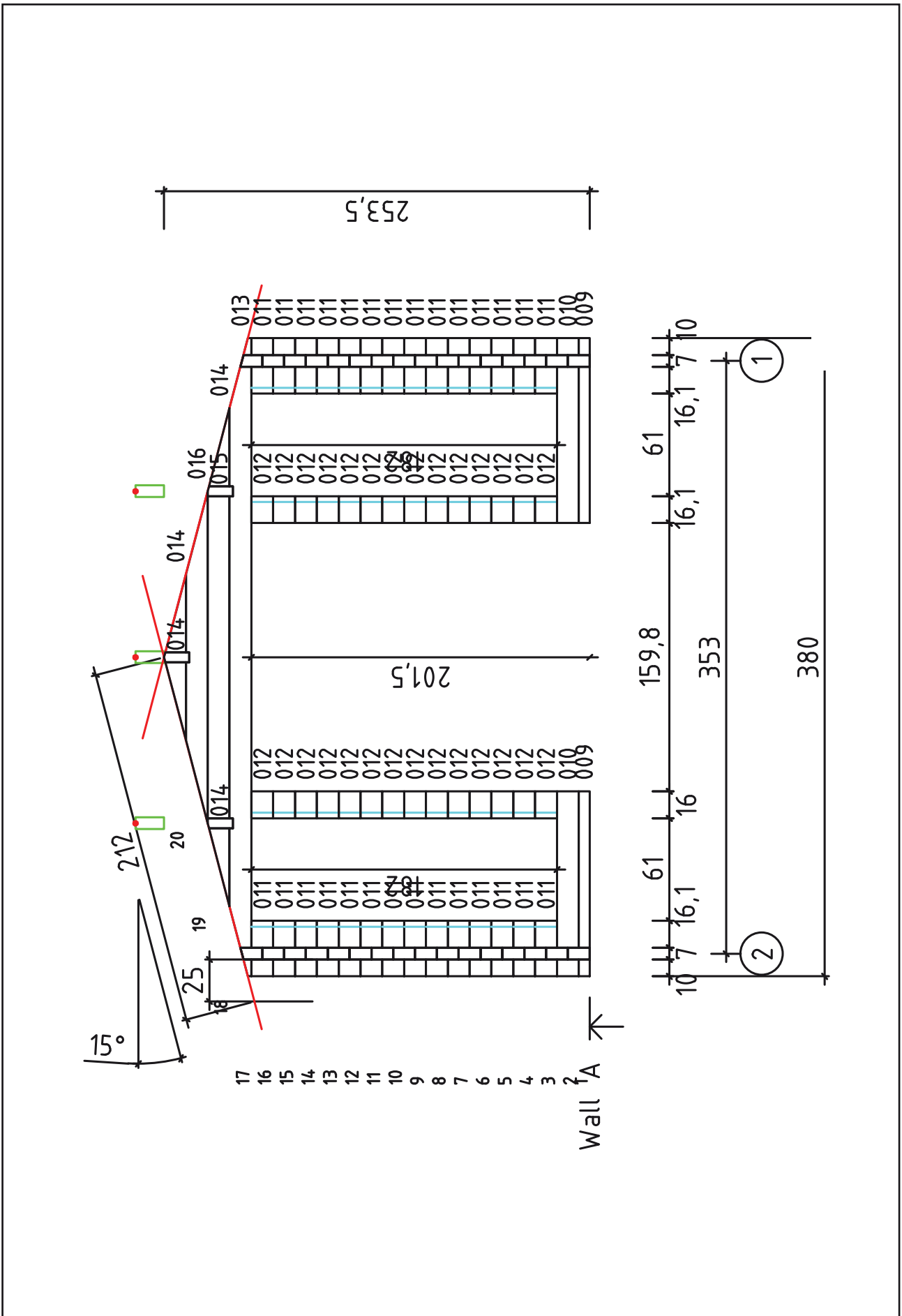

Wandplan B 870510

