

# Technische Daten: Art.-Nr.: 858115

Wandaußenmaß: 450 x 300 cm

Bohlenstärke: 58 mm



Alle Caro-Modelle sind spiegelbar.

Kontrolliert durch:

Achtung: Alle angegebenen Maße sind ca.-Maße!

# 3D Darstellung 858115

Das Haus Caro B lässt sich auch  
spiegelverkehrt aufbauen.

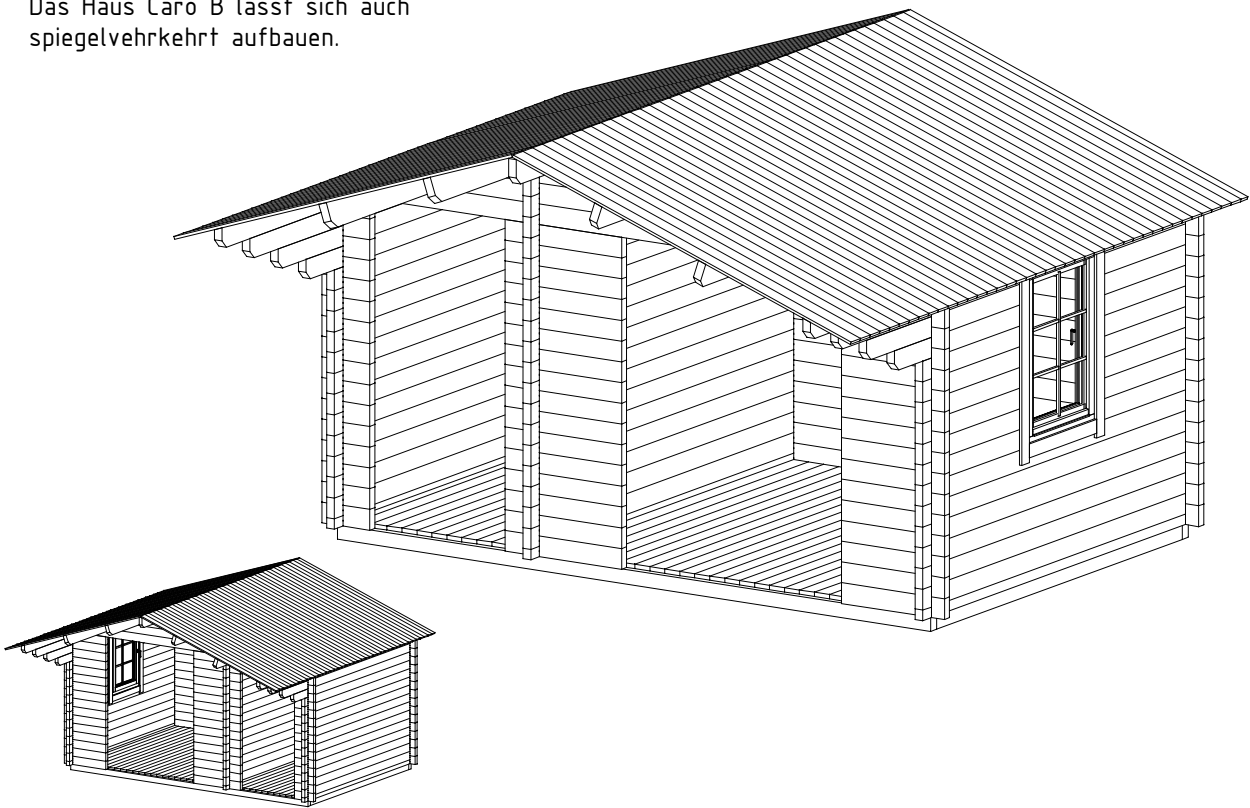

# Grundriss 858115

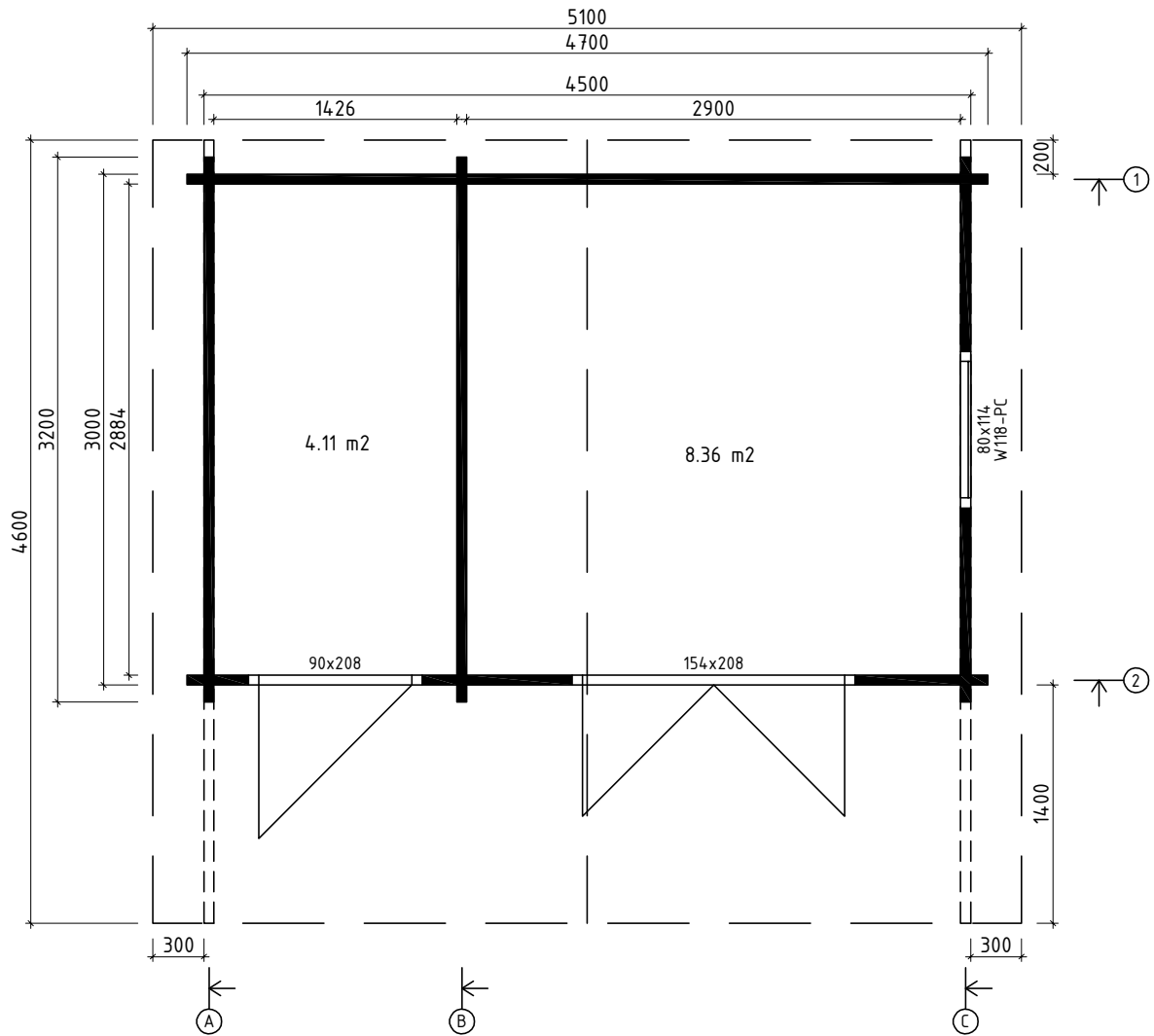

\*Fenster und Türen sind mit Sprossen

# Lagerholzplan 858115

**Wir empfehlen als Fundament für Ihr Gartenhaus eine vollflächig festgegründete, gepflasterte oder betonierte Fläche.  
Wahlweise ist auch ein Punkt- oder Streifenfundament möglich.**

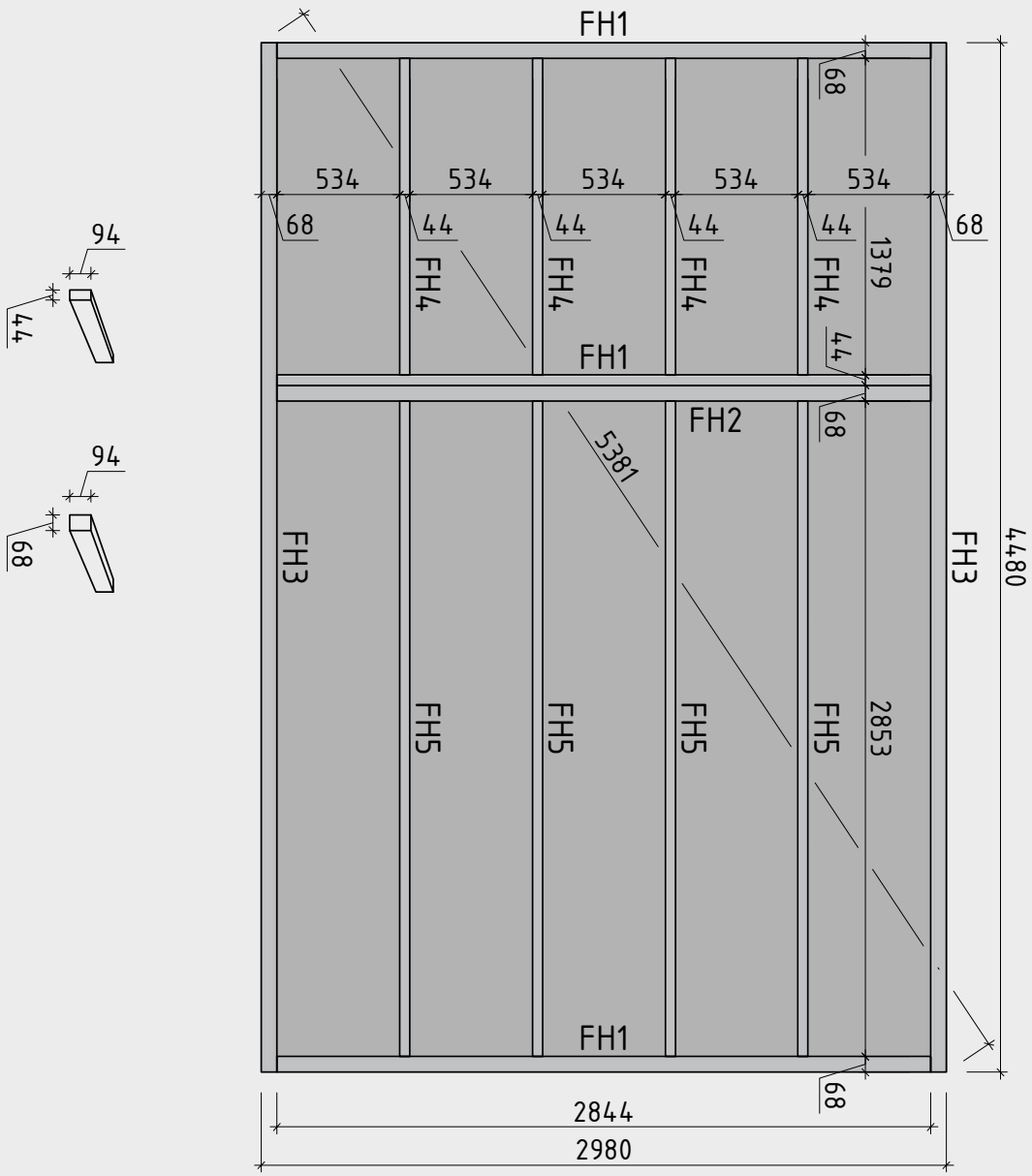











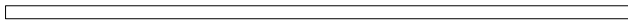

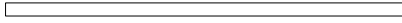



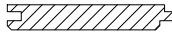



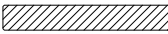



# Teileliste 1

## 858115

Pos		Stck	Profil (mm)	Länge (mm)
001		2	58x135	4700
002		16	58x135	4700
003		1	58x135	4600
004		1	58x135	4600
005		1	58x135	4175
006		2	58x135	3991
007		1	58x135	3850
008		1	58x135	3525
009		2	58x135	3204
010		2	58x68	3200
011		17	58x135	3200
012		1	58x135	3200
013		1	58x104	3200
014		19	58x135	3200
015		1	58x68	3200
016		2	58x135	2418
017		1	58x135	2115
018		1	58x135	1790
019		2	58x135	1631
020		1	58x135	1465
021		15	58x135	1140
022		16	58x135	881
023		16	58x135	778
024		4	58x135	398
025		16	58x135	361

# Teileliste 2

## 858115

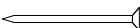
Pos		Stck	Profil (mm)	Länge (mm)
FH3	FUNDAMENTHÖLZER (imprägniert) 	2	68x94	4480
FH1	FUNDAMENTHÖLZER (imprägniert) 	3	68x94	2844
FH5	FUNDAMENTHÖLZER (imprägniert) 	4	44x94	2853
FH2	FUNDAMENTHÖLZER (imprägniert) 	1	44x94	2844
FH4	FUNDAMENTHÖLZER (imprägniert) 	4	44x94	1379
PF1		5	58x170	4600
	DACHBRETTER 	82+1	113x18	2696
	FUSSBODENBRETTER 	39+1	113x28	2879
	FUSSBODENLEISTEN  ✓		14x55	21,0 lfm
	ABDECKLEISTEN  ✓		15x28	30,0 lfm
G02-1	GIEBELBRETTER 18x120  18,9° ✓	4	18x120	2776
G01-1	GIEBELBRETTER 18x95  18,9° ✓	4	18x95	2776
G06-1	GIEBELDECKLEISTEN 18x58  ✓	4	18x58	2776
G08-1	GIEBELLEISTEN 18x58  18,9° ✓	4	18x58	2776
T01-1	TRAUFBRETTER 18x95 	2	18x95	4600
T06-1	TRAUFBRETTER 18x40  ✓		18x40	10,0 lfm
GS	Giebelsegment 	2		
TL58-1	T-LEISTE 58 	2	45x58	1165
TL58-2	T-LEISTE 58 	4	45x58	2110
SH	Schlaghölzer 	3		
KL1	Gewindestange M8 	4		2000
KL2	Gewindestange M8 	4		258
	Mutter M8 U-Scheibe Ø25 	8		
	Befestigungsmutter M8 	4		
NG04	NÄGEL 2.5x50 Dachbretter 	656		

# Teileliste 3

## 858115

Pos			Stck.	Profil (mm)	Länge (mm)
NG05	NÄGEL 2.5x60 Fussbodenbretter		468		
SR32	SCHRAUBEN 3.0x30 Fussbodenleisten, Abdeckleisten Traufenleisten 40x18		124		
SR37	SCHRAUBEN 3.5x45 Giebelbretter, Traufenbretter Giebeldeckleisten, Giebelsegment Fenster- und Türleisten		144		
SR57	SCHRAUBEN 5.0x100 Fundamenthölzer		36		
	<p>FENSTER Q4 <span style="float: right;">800x1140 W4-S58P-06C-08001140</span></p> <div style="display: flex; align-items: center;"> <div style="flex: 1;"> </div> <div style="flex: 2;"> <p style="text-align: center;">WL1</p> <p style="text-align: center;">L1</p> <p style="text-align: center;">L2</p> <p style="text-align: center;">L3 ✓</p> </div> <div style="flex: 2;"> <p>L1 18x90 L=1040mm 2x</p> <p>L2 18x90 L=1260mm 4x</p> <p>L3 18x90 L=800mm 2x ✓</p> <p>WL1 36x129 L=1040mm 1x</p> </div> </div>	1			
	✓ - bitte selber anpassen (falls nötig)!				

# Wandpläne 1 und 2 858115

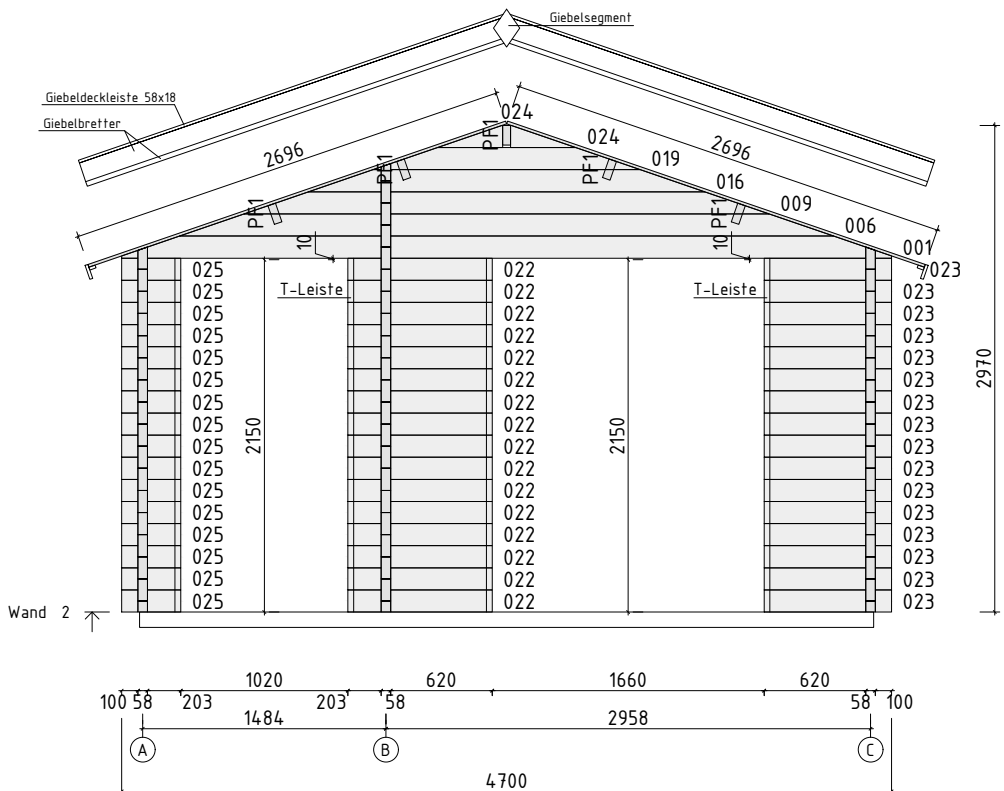
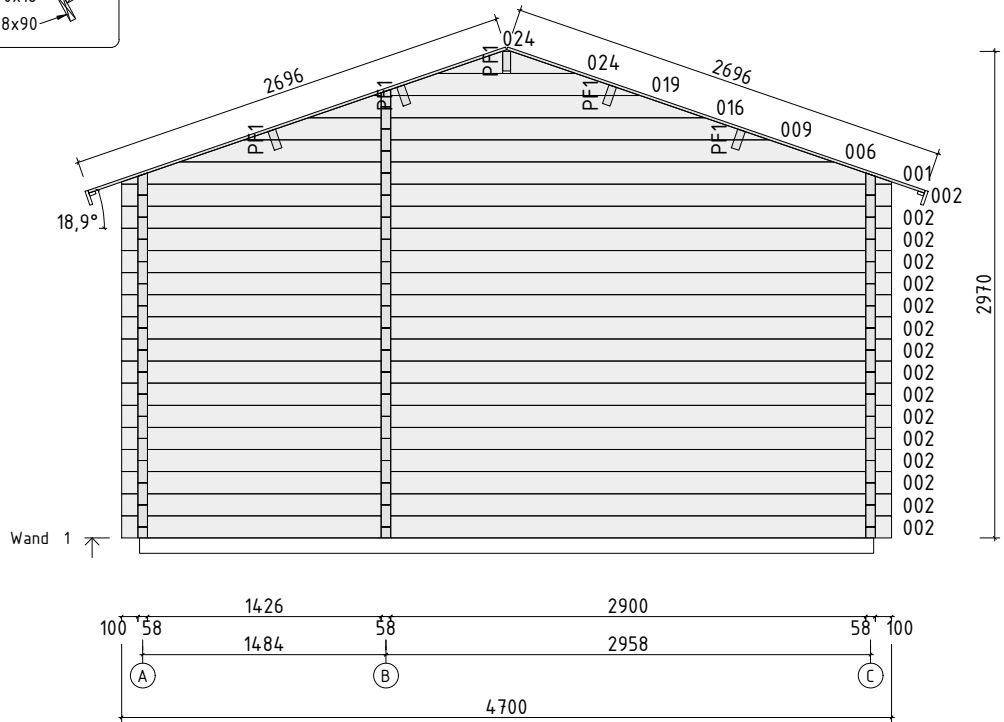
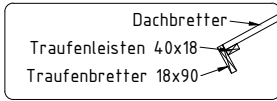



# Wandpläne A und B 858115

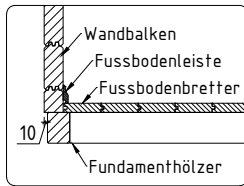
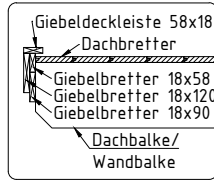

Wand A ↗

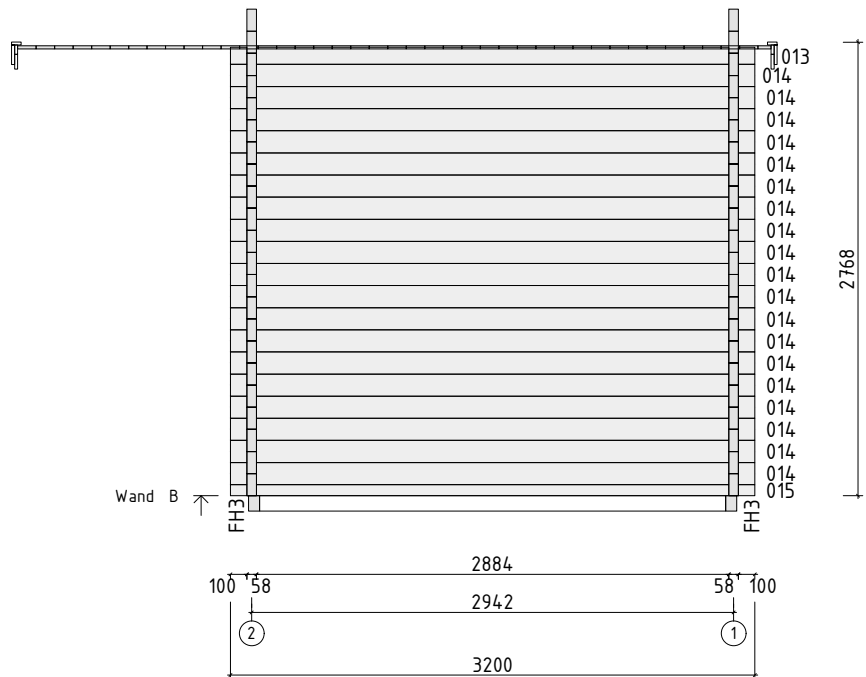
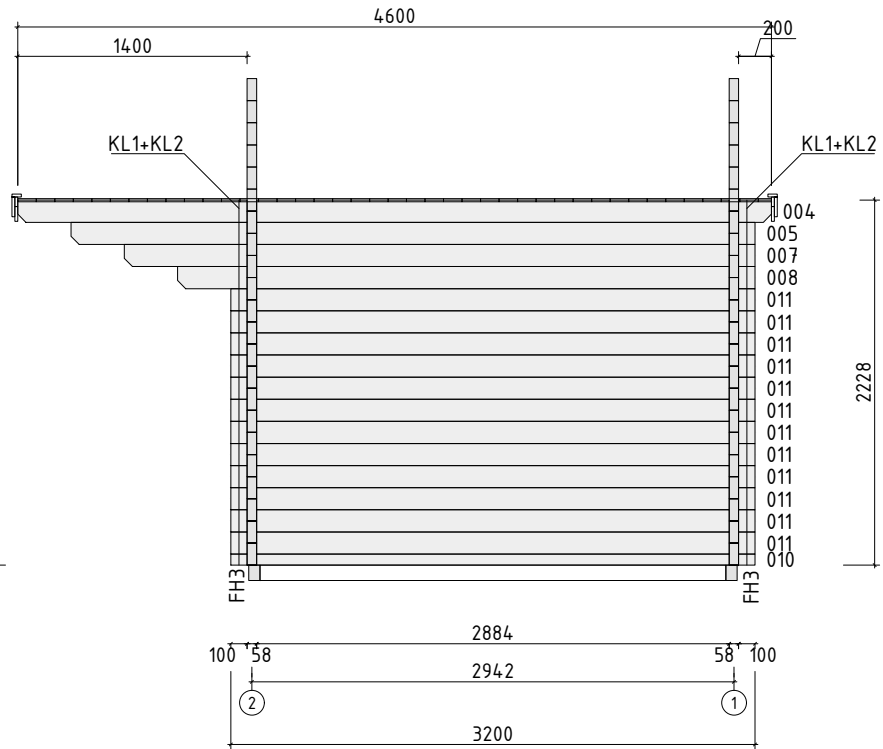

Wand B ↗

# Wandplan C 858115

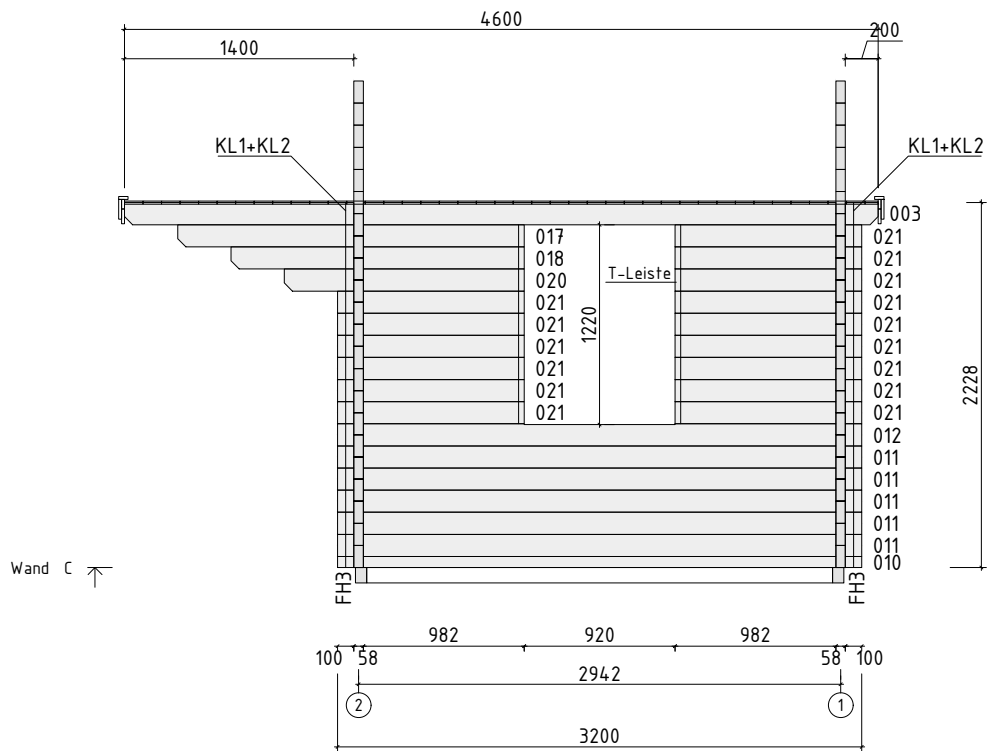

# Details 858115

Montageanleitung für T-Leisten / Installing the door and  
window supports / Tenderliistu paigaldusjuhend.

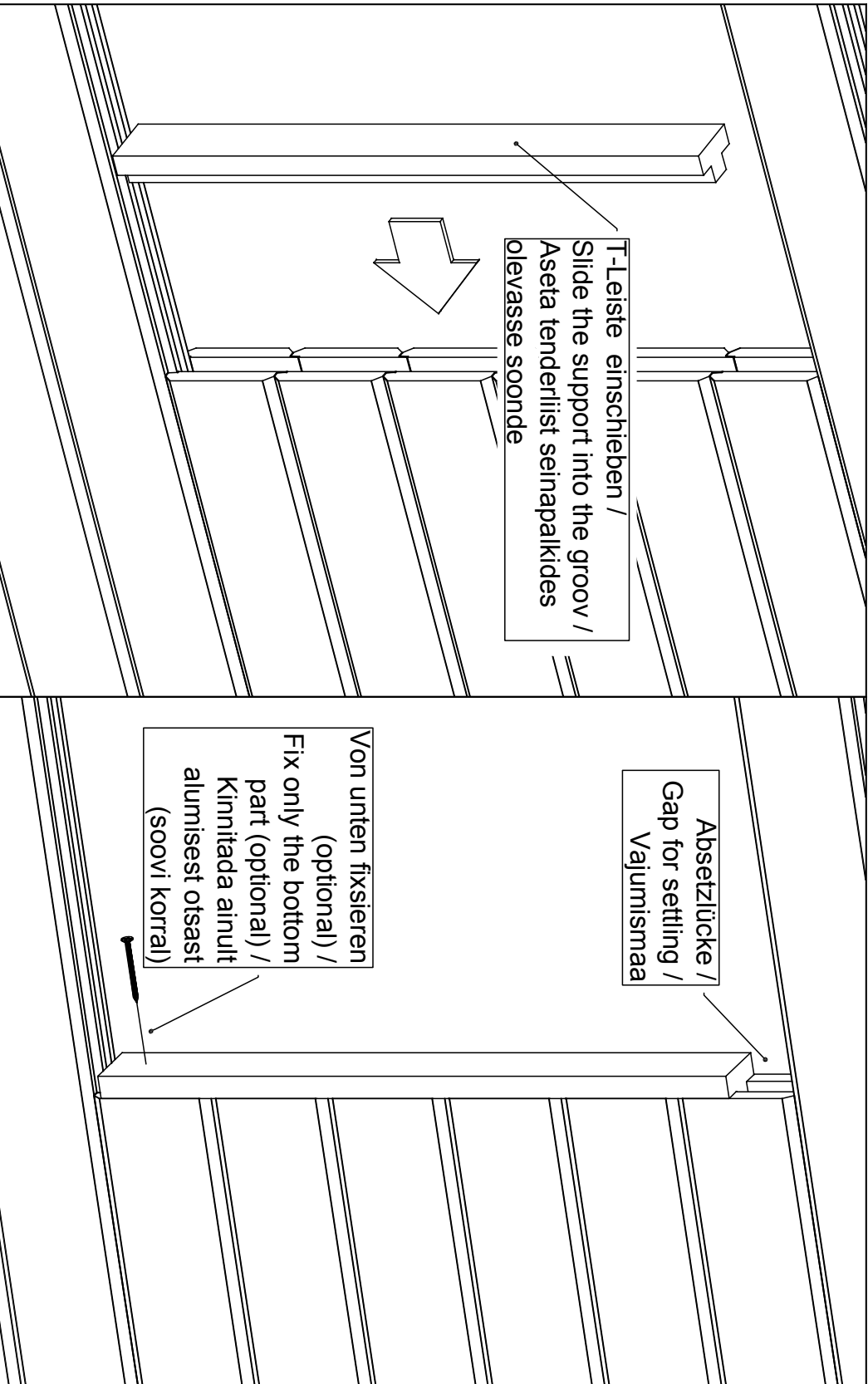

# Details 858115

Akna tüüp / Fenster typ / Window type - A68  
(GH+ / SH)

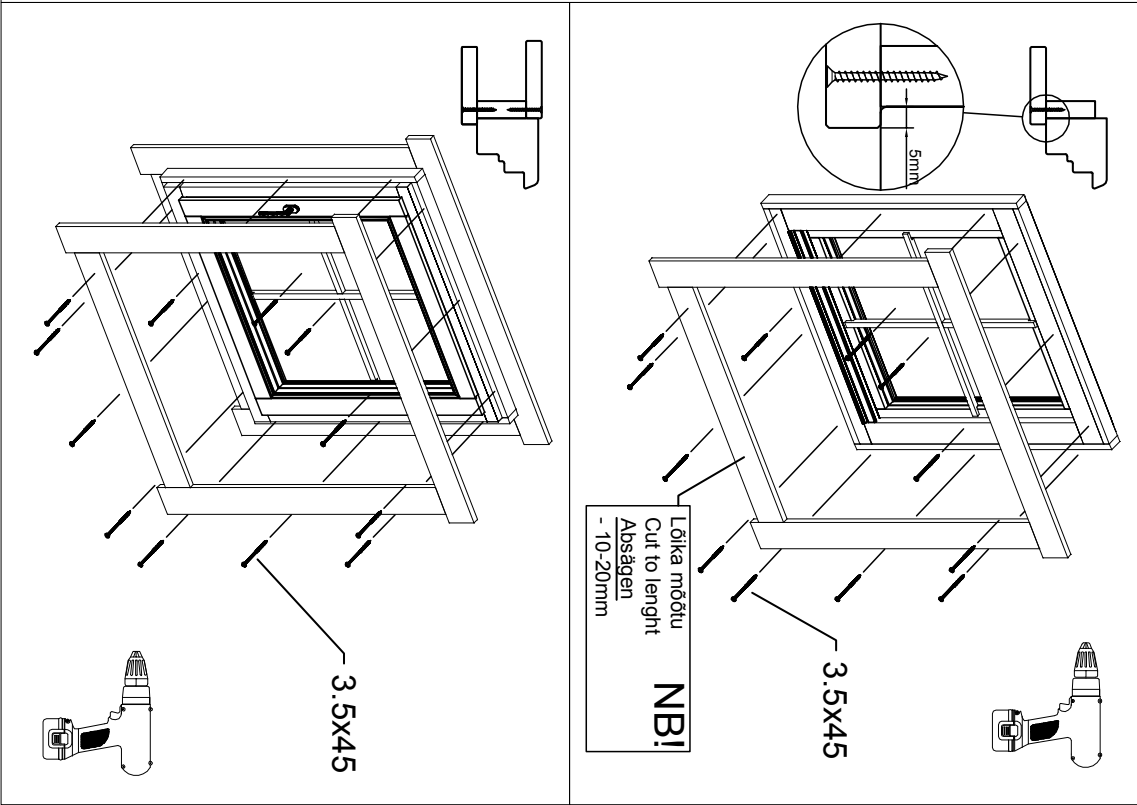
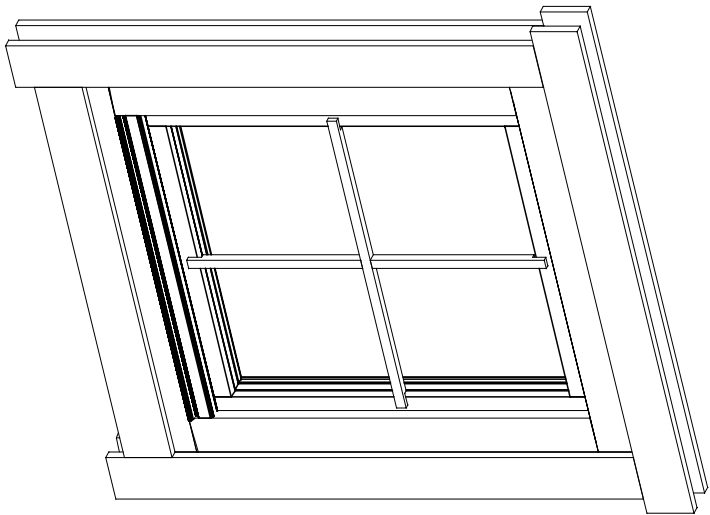

# Details

## 858115

TÜR 900x2080 U1-SH 1 Stck. DIN links

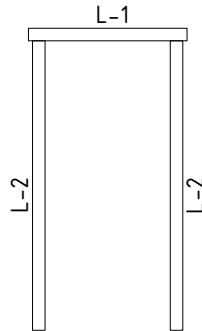
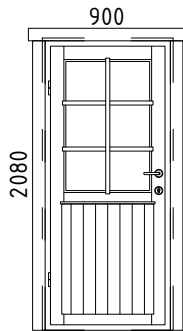

Die Leisten für eine Tür

L-1	18x90	L=1140mm	2 Stck.
L-2	18x90	L=2080mm	4 Stck.✓

TÜR 1540x2080 TU3-SH 1 Stck. DIN rechts

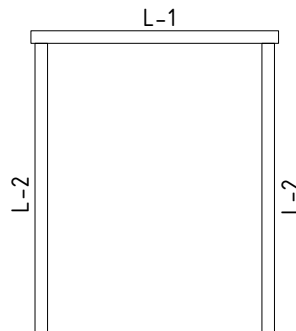
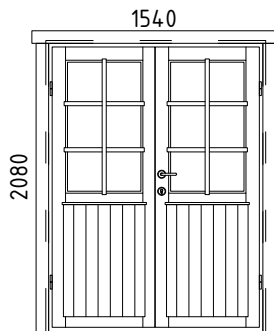

Die Leisten für eine Tür

L-1	18x90	L=1780mm	2 Stck.
L-2	18x90	L=2080mm	4 Stck.✓

Schrauben 3,5x45

(Blendleisten)

48 Stck

# Details 858115

TÜR 900x2080 U5-SH 1 Stck. DIN links

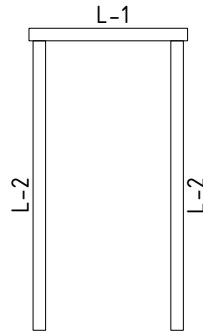
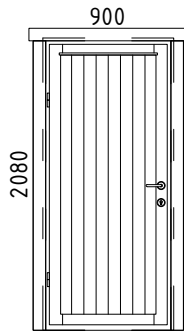

Die Leisten für eine Tür

L-1	18x90	L=1140mm	2 Stck.
L-2	18x90	L=2080mm	4 Stck.✓

TÜR 1540x2080 TU4-SH 1 Stck. DIN rechts

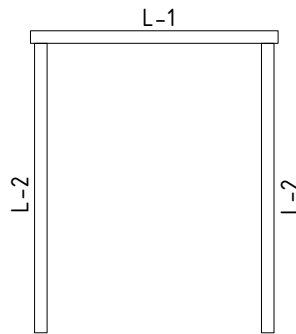
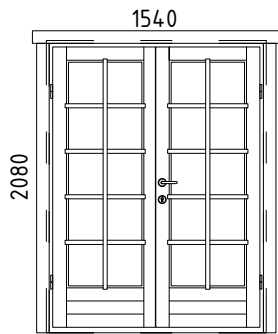

Die Leisten für eine Tür

L-1	18x90	L=1780mm	2 Stck.
L-2	18x90	L=2080mm	4 Stck.✓

Schrauben 3,5x45

(Blendleisten)

48 Stck