

Technische Daten



Spiegelverkehrte Montage möglich.

Artikelnummer:

847 410

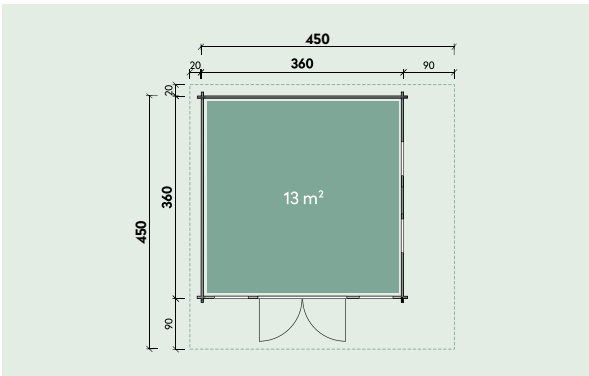



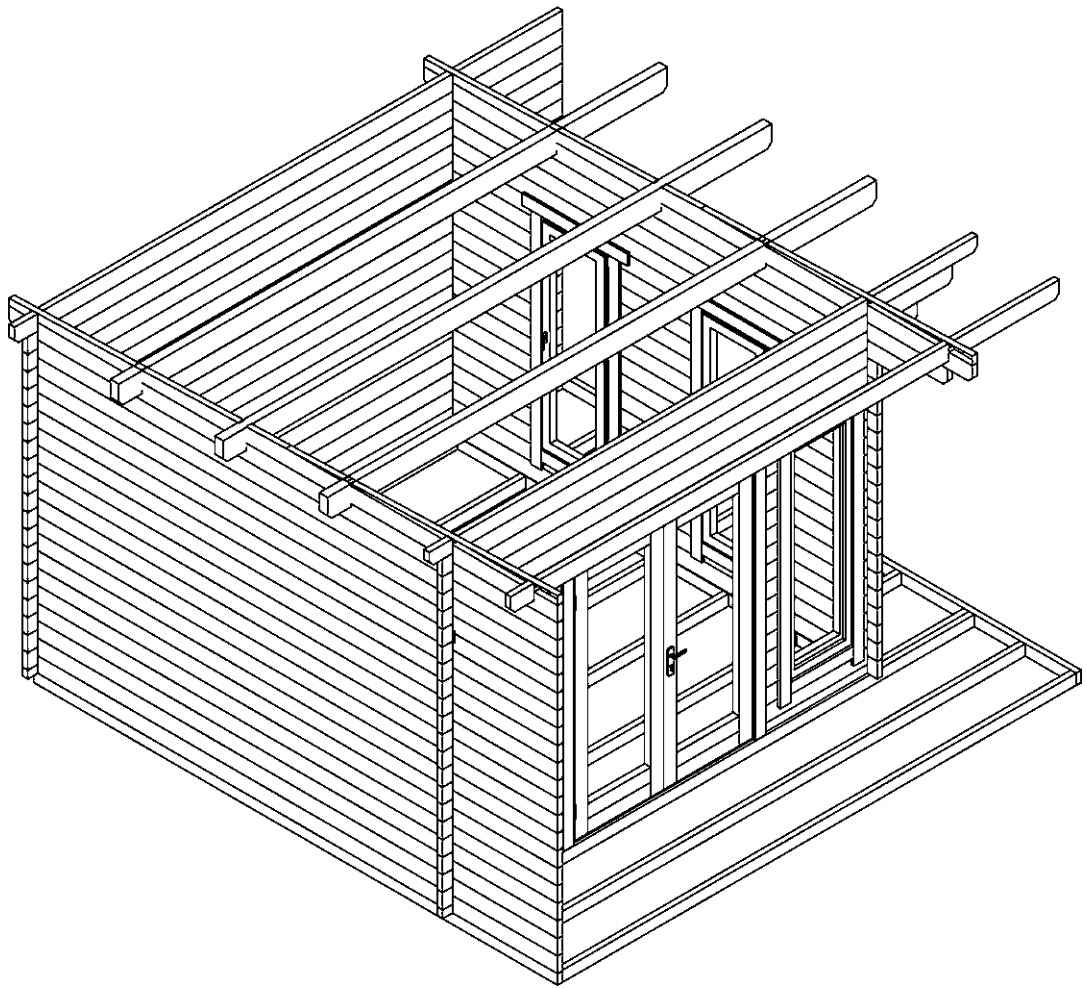

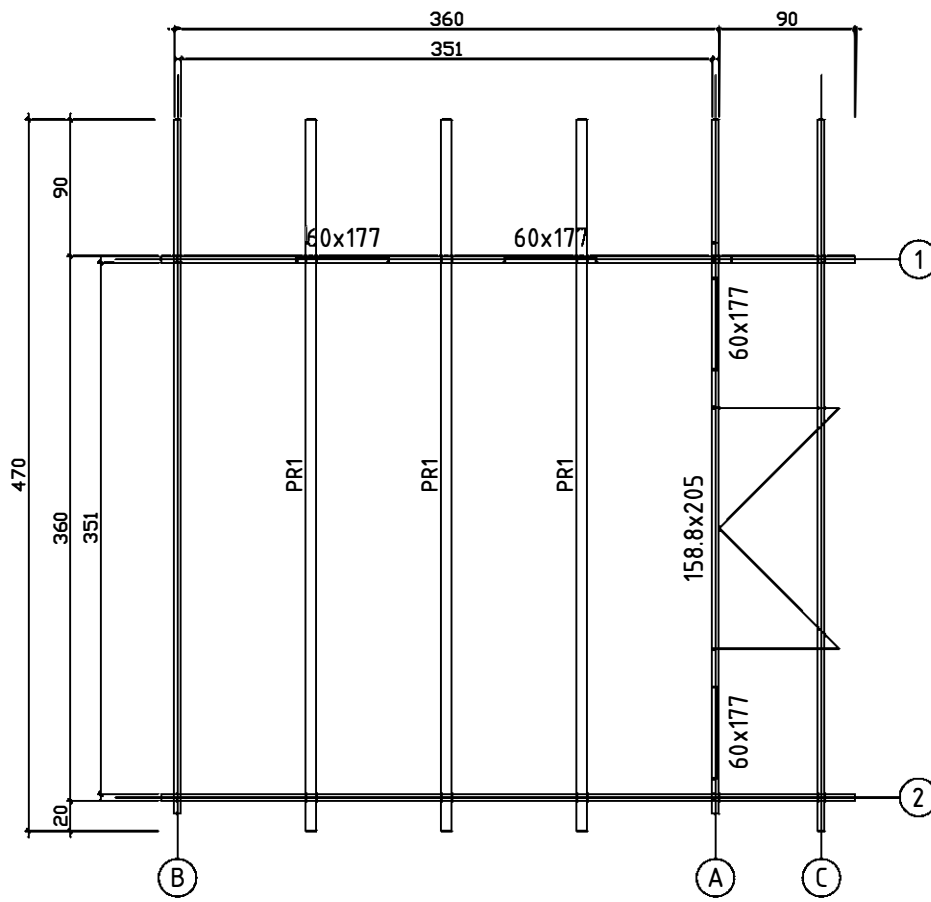
Kontrolliert durch:



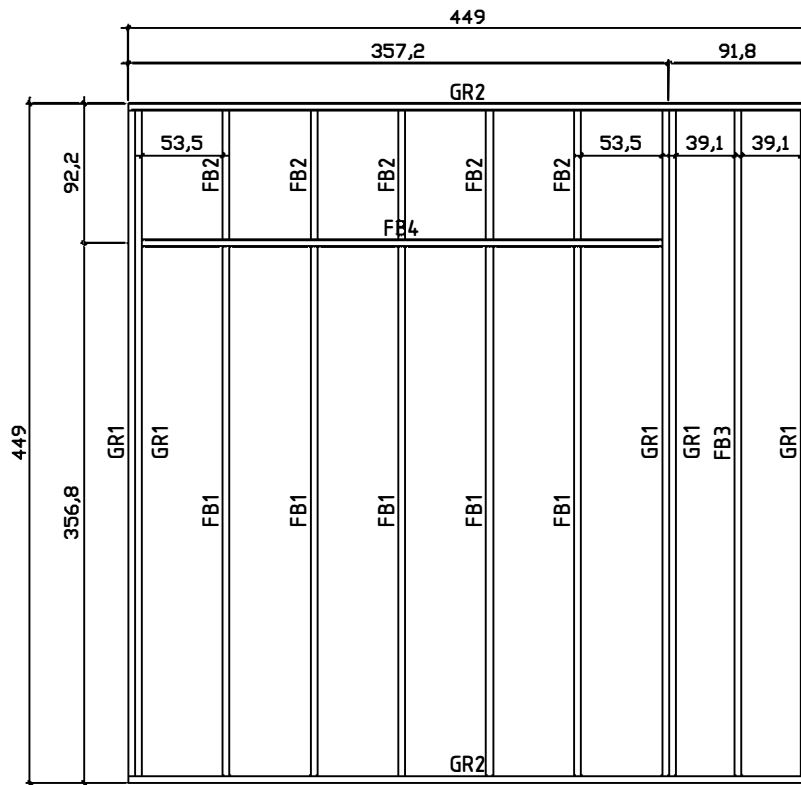

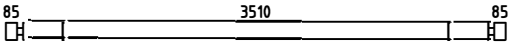
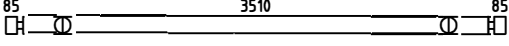
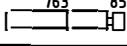
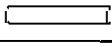
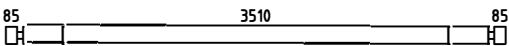
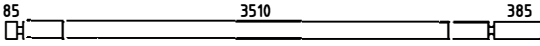
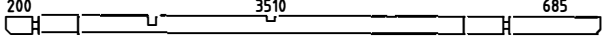
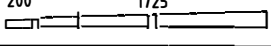
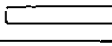
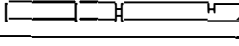
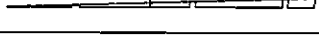
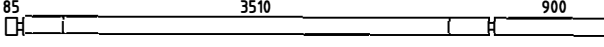
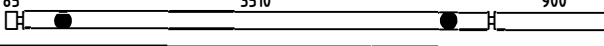
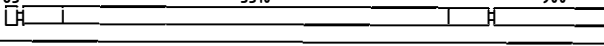
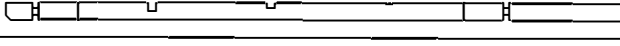
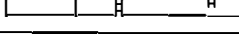
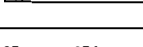
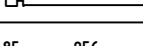
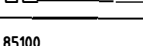

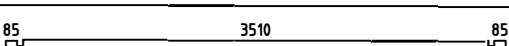
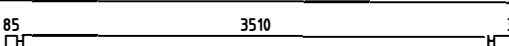
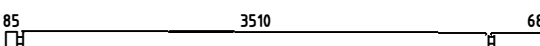













Wir empfehlen als Fundament für Ihr Gartenhaus eine vollflächig festgegründete, gepflasterte oder betonierte Fläche. Wahlweise ist auch ein Punkt- oder Streifenfundament möglich.

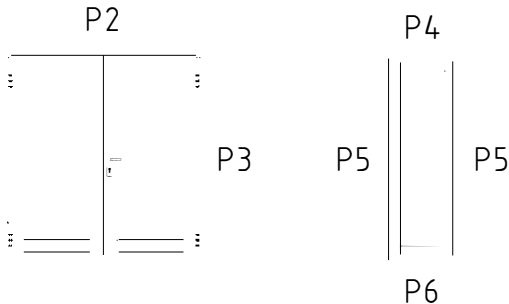

Pos		Quantity	Profil (mm)	Length (mm)
001		1	45x130	3770
002		1	45x130	3770
003		28	45x130	893
004		14	45x130	763
005		2	45x130	3770
006		1	45x130	4070
007		1	45x130	4485
008		2	45x118	1970
009		2	45x130	835
010		1	45x130	1775
011		2	45x71	2328
012		1	45x130	4585
013		1	45x130	4585
014		17	45x130	4585
015		1	45x130	4700
016		1	45x130	1775
017		2	45x65	1086
018		2	45x130	1086
019		2	45x130	1086
020		26	45x130	230
021		26	45x130	246
022		1	45x130	3770
023		2	45x130	3770
024		1	45x130	4070
025		1	45x130	4370

Pos		Quantity	Profil (mm)	Lenght (mm)
026		1	45x109	4700
027		1	45x65	4585
028		19	45x130	4585
029		1	45x130	4700
030		1	45x130	4700
GR2	GROUNDFRAME 	2	45x90	4490
GR1	GROUNDFRAME 	5	45x90	4400
FB3	FLOORBEAMS 	1	45x90	4400
FB1	FLOORBEAMS 	5	45x90	3500
FB4	FLOORBEAMS 	1	45x90	3438
FB2	FLOORBEAMS 	5	45x90	855
PR1	Purlins 	3	70x170	4700
	WINDOW 600x1770	4		
	DOOR 1588x2050	1		
1	Screws/Schrauben/Vis 5x100 mm- For fixing first row of wall logs /Fixierung des ersten Bohlenkranzes/Pour fixer les lames de plancher	6		
2	Nails/Nägels/Clous 2.5x50 - For fixing floorboards/ Befestigung Fussbodenbretter/Pour fixer les lames de plancher	500		
3	Nails/Nägels/Clous 2.5x50 - For fixing roofboards/ Befestigung Dachbretter/Pour fixer les voliges	325		
4	Nails/Nägels/Clous 2.5x50 - For fixing floor edge trims/ Befestigung Fussleisten/Pour fixer les plinthes du plancher	30		
5	Nails/Nägels/Clous 2.5x50 - For fixing roofing felt fillet/ Befestigung giebelabschlussbrett/Pour fixer la latte de finition de la couverture	30		
6	Screws/Schrauben/Vis 2,5x50 mm- For fixing roof side boards and roof edge reinforcement Befestigung Traufenbretter und Traufenteisten Pour fixer les planches de rive et le tasseau de refront	125		
7	Screws/Schrauben/Vis 2,5x50 mm- For fixing fascia boards and diamonds/ Befestigung Giebelblende und Raute Pour fixer les planches de rive et le diamant			
8	Screws/Schrauben/Vis 2,5x50 mm- For fixing fwindow and door trims/ Befestigung Fenster und türen/ Pour fixer les croisillons des fenetres et des portes			
9	Metal storm Brace/Gewindestange/Tige filetee 8 mm	4		
10	Shim/Nuts/Mutter ,U-Scheibe/Ecrou/Rondelle 8 mm For fixing storm braces/ Pour fixer les anti tempete/ Für Sturmleisten Pour fixer les croisillons des fenetres et des portes Metal storm Brace/Gewindestange/Tige filetee 8 mm KL1 M8 2,90 m 2 Screws 180 8 pcs. KL2 M8 2,82 m 2 Plastic caps 4 pcs.	4/4		

POS	ST.	B	H	L	
FB1	Vt. spetsi				 FUNDMENTHOLZER
F1	12,3m ²	28		3505	 FUSSBODENBRETTER
F2	3,2m ²	28		900	 TERRASSE FUSSBODENBRETTER
F3	4m ²	28		4455	 TERRASSE FUSSBODENBRETTER
PR	3	70	170	4700	 DACHBALKEN
RB1	22,1m ²	20		4702	 DACHBRETTER
R1	2	20	140	4740	<small>Vaata kaluse kaldenurka</small>  Traufenbretter
R2	2	45	65	4700	<small>Vaata kaluse kaldenurka</small>  Traufenbretter
R3	2	20	140	4900	<small>Vaata kaluse kaldenurka</small>  Giebelabschlussleiste
R4	2	20	90	4900	 Giebelabschlussleiste
DR1 WN1	1 4	1588 600	2050 1770		
P1	15m	20	40		 Fußbodenleiste
P2	1+1	20	90	1890	 Türleiste DR1
P3	2+2	20	90	2030	 Türleiste DR1
P4	4+4	20	90	900	 Fensterleiste WN1
P5	8+8	20	90	1920	 Fensterleiste WN1
P6	4+4	20	90	540 570	 Fensterleiste WN1

