

Technische Daten

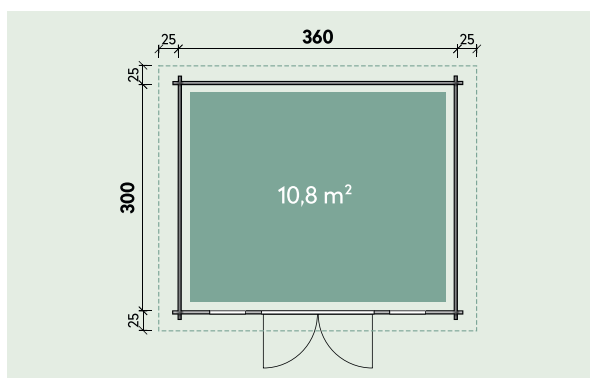

Artikelnummer:

847 200





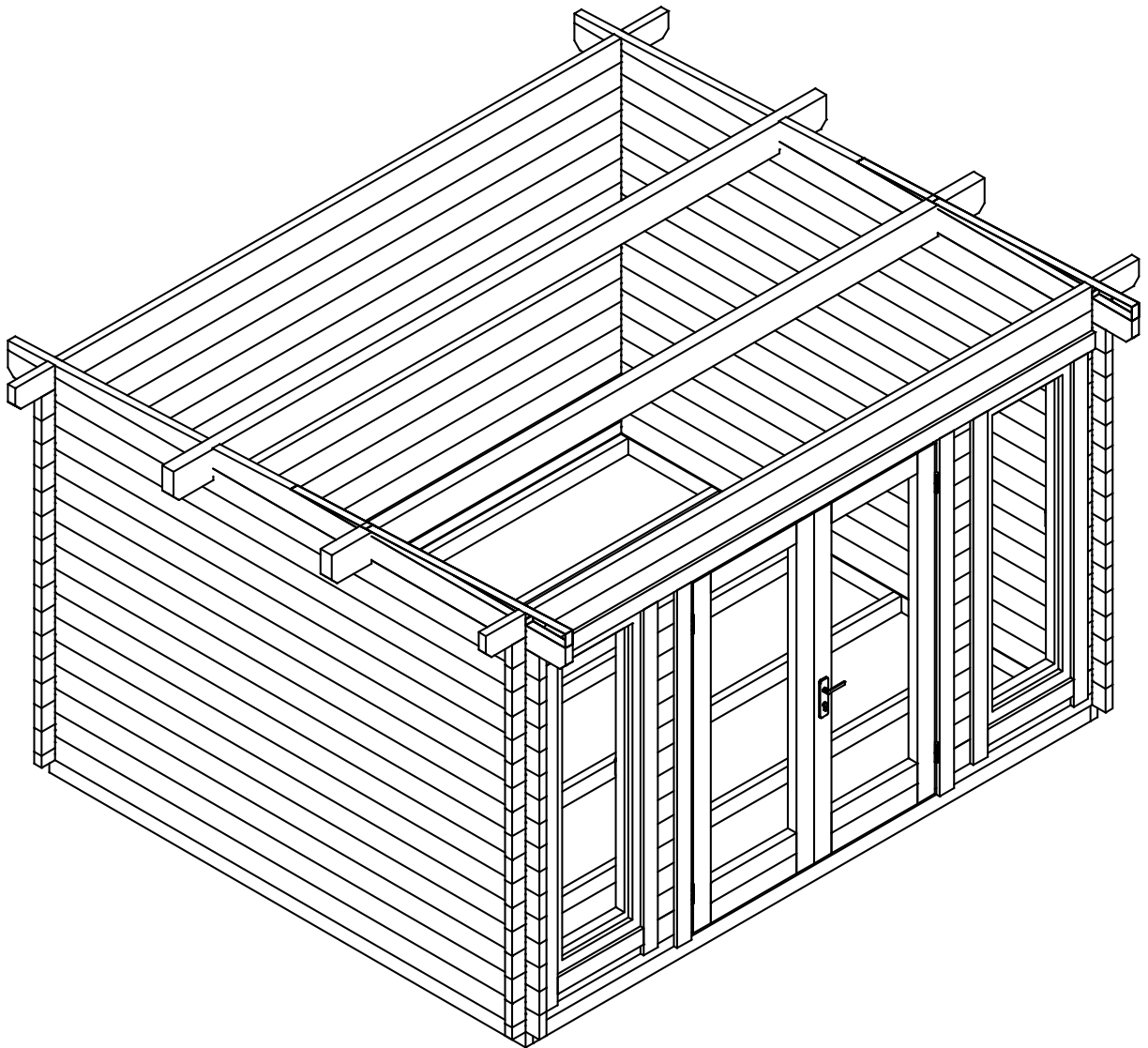

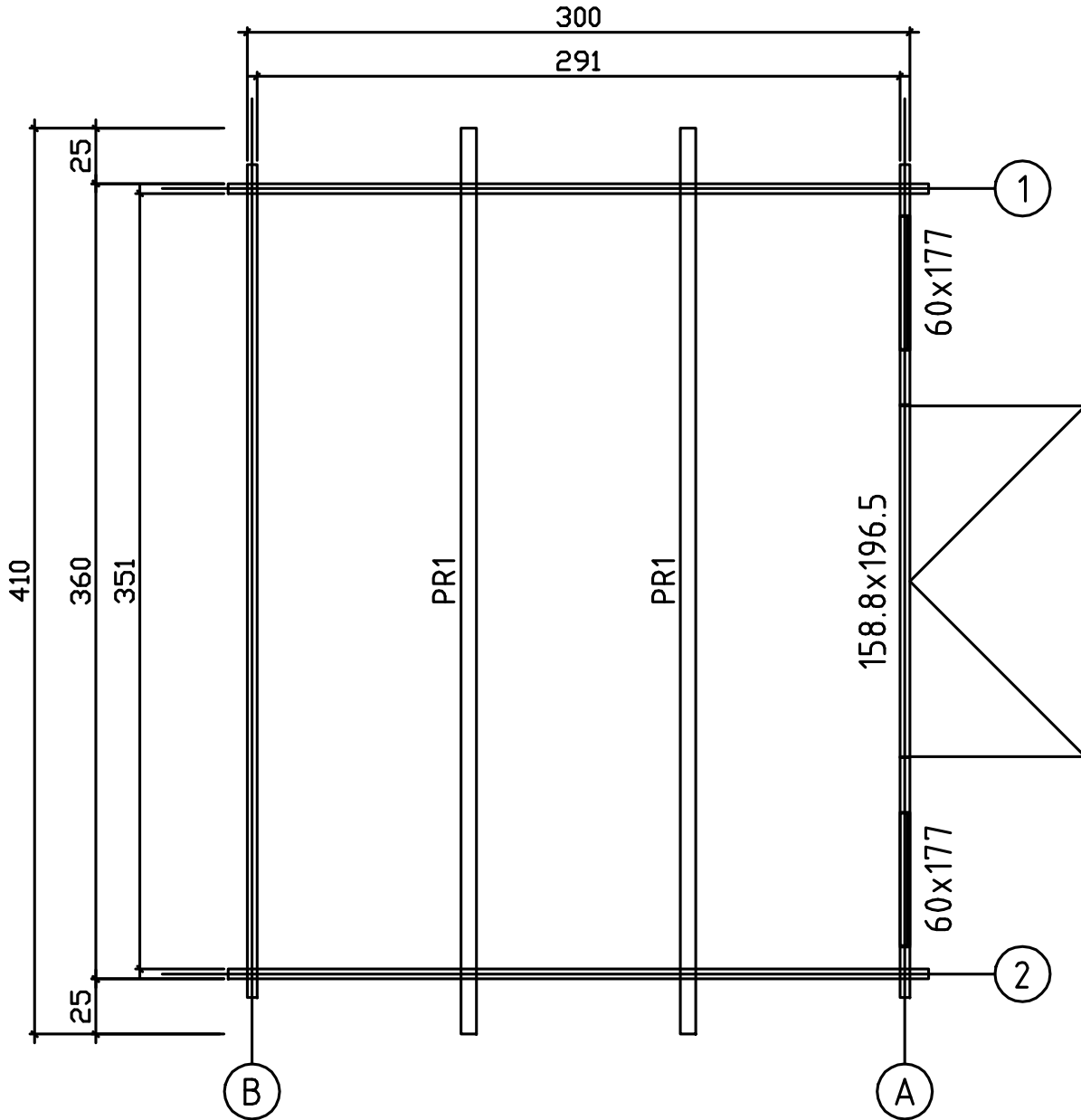

Kontrolliert durch:

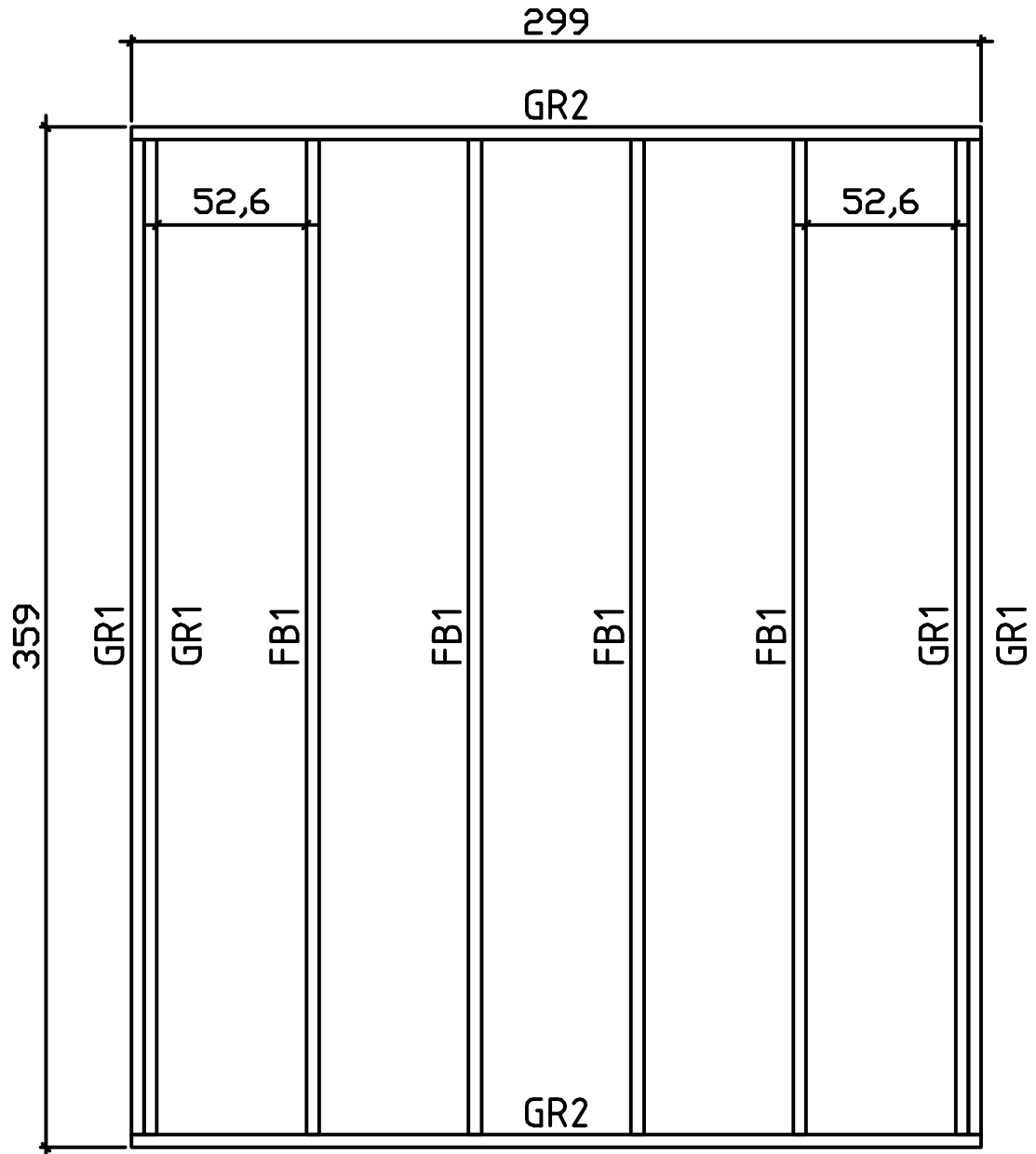

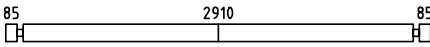
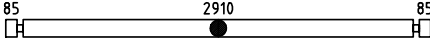
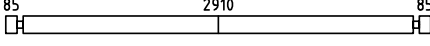
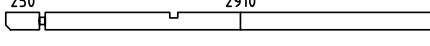

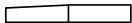
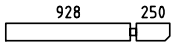
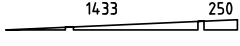
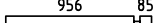
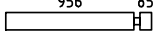

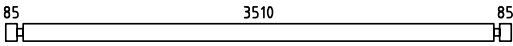
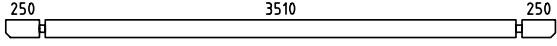
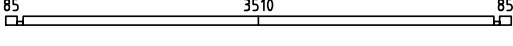
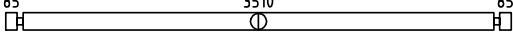
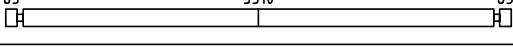
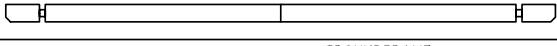
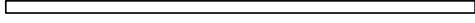

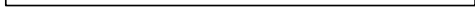
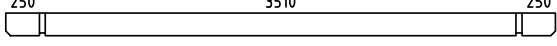

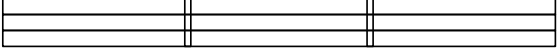
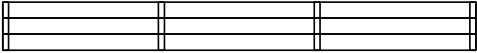







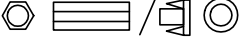









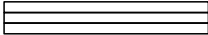
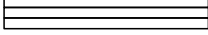

Wir empfehlen als Fundament für Ihr Gartenhaus eine vollflächig festgegründete, gepflasterte oder betonierte Fläche. Wahlweise ist auch ein Punkt- oder Streifenfundament möglich.

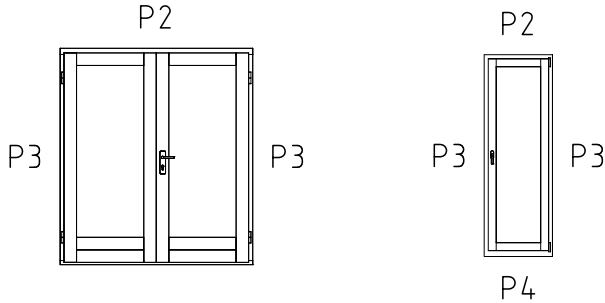

Pos	Drawing Malmö 45-A	Quantity	Profil (mm)	Lenght (mm)
001		2	45x130	3170
002		2	45x130	3170
003		26	45x130	3170
004		2	45x130	3335
005		2	45x106	1223
006		2	45x130	933
007		2	45x130	1223
008		2	45x76	1728
009		2	45x65	1086
010		2	45x130	1086
011		28	45x130	230
012		28	45x130	246
013		1	45x130	3770
014		1	45x130	4100
015		1	45x65	3770
016		1	45x130	3770
017		14	45x130	3770
018		1	45x130	4100
GR1		4	45x90	3500
GR2		2	45x90	2990
FB1		4	45x90	3500
PR1		2	70x170	4100
	WINDOW 600x1770	2		
	DOOR 1588x1965	1		
Kood	Malmö 45-A	Materjal	File Malmö 45-A.dwg	Leht 1/2

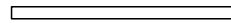
Nr.		Menge	Profil (mm)	Länge (mm)
	<p style="text-align: center;">Dachblende R1 - 2 pcs.</p>  <p style="text-align: center;">Dachblende R2 - 2 pcs.</p> 			
1	Screws/Schrauben/Vis 5x100 mm- For fixing first row of wall logs /Fixierung des ersten Bohlenkranzes/Pour fixer les lamesde plancher 	6		
2	Nails/Nägel/Clous 2.5x50 - For fixing floorboards/ Befestigung Fussbodenbretter/Pour fixer les lames de plancher 	250		
3	Nails/Nägel/Clous 2.5x50 - For fixing roofboards/ Befestigung Dachbretter/Pour fixer les voliges 	250		
4	Nails/Nägel/Clous 2.5x50 - For fixing floor edge trims/ Befestigung Fussleisten/Pour fixer les plinthes du plancher 	30		
5	Screws/Schrauben/Vis 2,5x50 mm- For fixing parapet / Befestigung parapet / Pour fixer les parapet 	145		
6	Screws/Schrauben/Vis 2,5x50 mm- For fixing window and door trims/ Befestigung Fenster und türen/ Pour fixer les croisillons des fenetres et des portes 			
7	Metal storm Brace/Gewindestange/Tige filetee 8 mm 	3		
8	Shim,Nuts/Mutter ,U-Scheibe/Ecrou,Rondelle 8 mm For fixing storm braces/ Pour fixer les anti tempete/ Für Sturmleisten Pour fixer les croisillons des fenetres et des portes Metal storm Brace/Gewindestange/Tige filetee 8 mm KL1 M8 2,25 m 1 Screws 180 6 pcs. KL2 M8 2,31 m 2 Plastic caps 3 pcs. 	3/3		
9	Roofing felt/Dachpappe/Feutre de toiture	10+15		
10	Nails/Nägel/Clous - For fixing roofing felt/ Befestigung Dachpappe/Pour fixer les feutre de toiture 	160		

POS	ST.	B	H	L	Teileliste	
FB1	Vt. spetsi					FUNDMENTHOLZER 
F1	10,2m ²	28		2905		FUSSBODENBRETTER
PR	2	70	170	4100		DACHBALKEN 
RB1	14,4m ²	20		3503		DACHBRETTER
R1	2	20	360	4140		Dachblende
R2	2	20	360	3545		Dachblende
R3	2	45	45	4100		BEFESTIGUNG DACHBRETTER 
R4	2 2	45	90	250 295		BEFESTIGUNG PARAPET 
DR1 WN1	1 2	1588 600	1965 1770			
P1	14m	20	40			Fussbodenleiste
P2	1+1	20	90	3490		Türleiste DR1,WN1 
P3	6+6	20	90	1945		Türleiste DR1,WN1 
P4	2+2	20	90	540 570		Fensterleiste WN1 