

Technische Daten: Art.-Nr.: 847 150

Wandaußenmaß: 500 x 500 cm

Bohlenstärke: 44 mm



Kontrolliert durch:

Achtung: Alle angegebenen Maße sind ca.-Maße!

3D-Darstellung Art.-Nr. 847 150

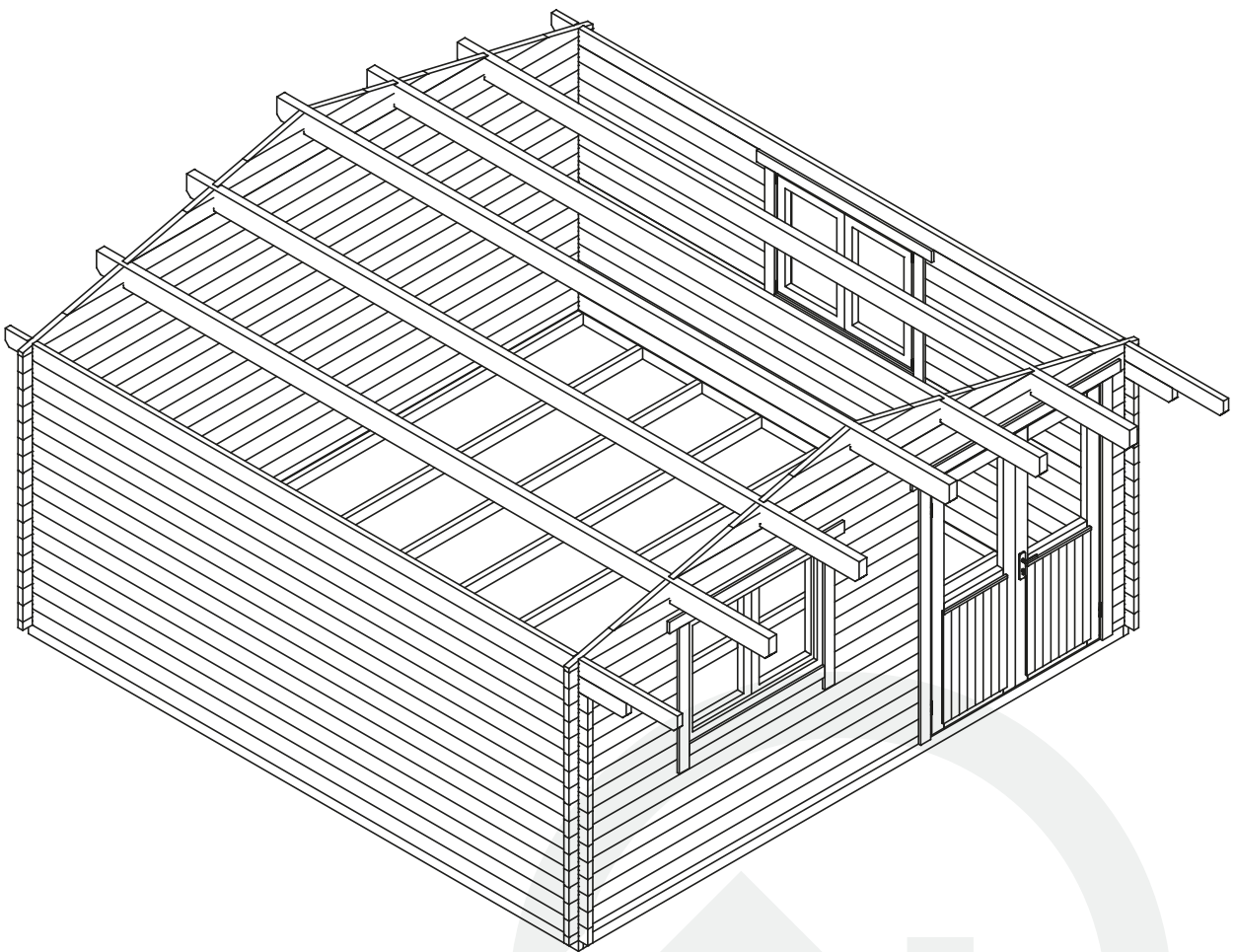

Grundriss

Art.-Nr. 847 150

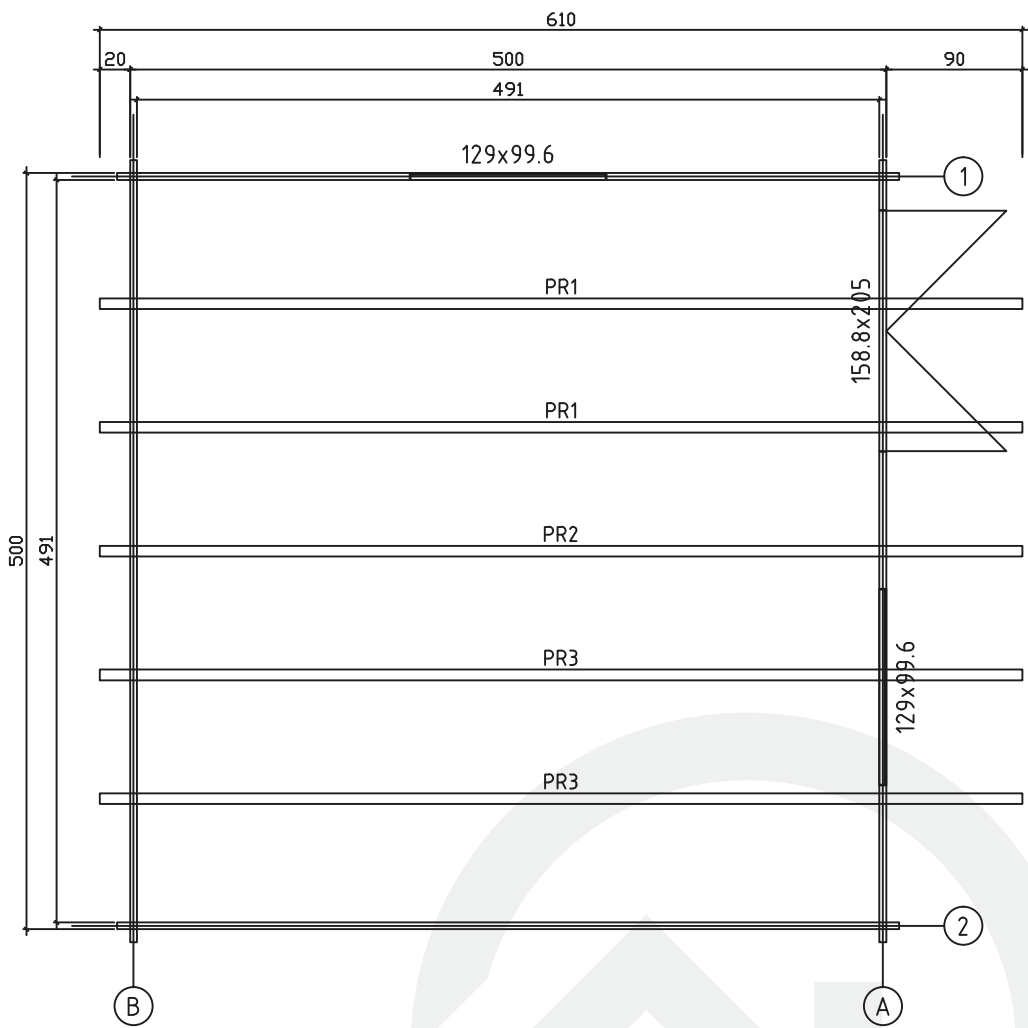





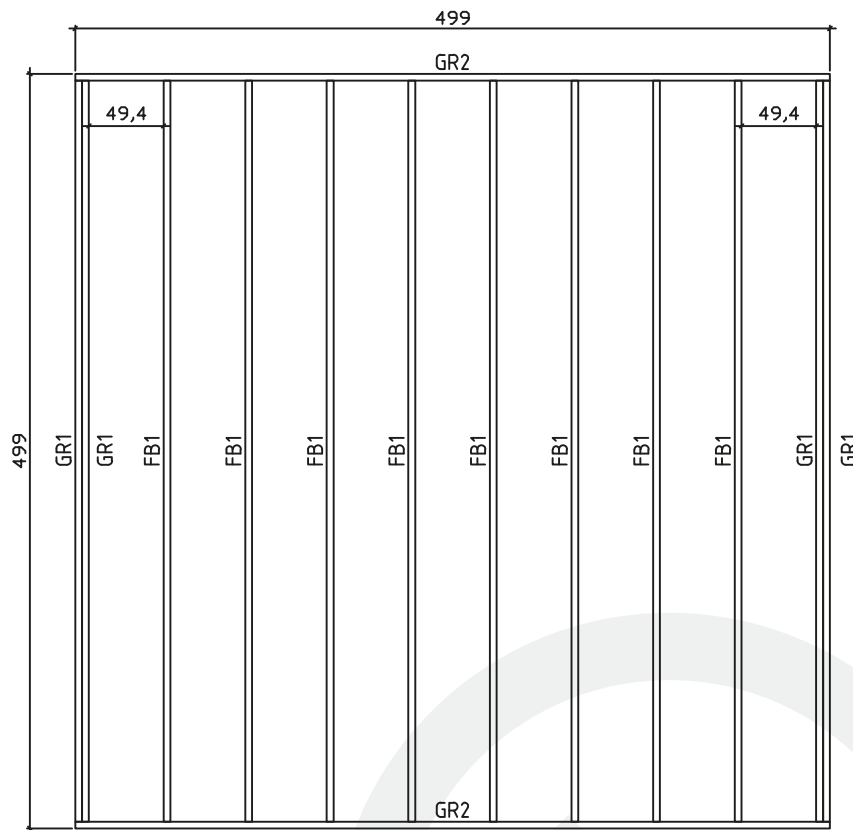





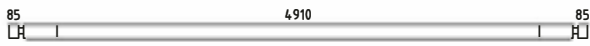
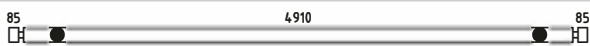

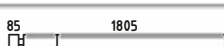
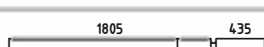
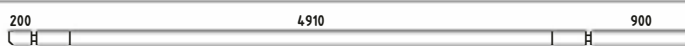

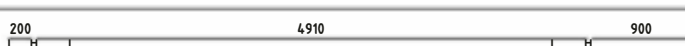



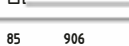

Lagerholzplan und Fundamentplan Art.-Nr. 847 150

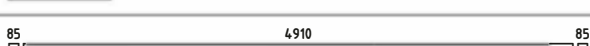
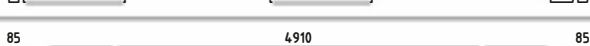
Wir empfehlen als Fundament für Ihr Gartenhaus eine vollflächig festgegründete, gepflasterte oder betonierte Fläche.
Wahlweise ist auch ein Punkt- oder Streifenfundament möglich.



















Teileliste 1

Art.-Nr. 847 150

| Nr. | | Stück | Profil (mm) | Länge (mm) |
|-----|--|-------|-------------|------------|
| 001 |  | 2 | 45x130 | 5170 |
| 002 |  | 2 | 45x130 | 5170 |
| 003 |  | 19 | 45x130 | 5170 |
| 004 |  | 15 | 45x130 | 1935 |
| 005 |  | 1 | 45x130 | 2285 |
| 006 |  | 1 | 45x130 | 6100 |
| 007 |  | 1 | 45x130 | 5520 |
| 008 |  | 1 | 45x130 | 6100 |
| 009 |  | 1 | 45x65 | 3242 |
| 010 |  | 1 | 45x65 | 330 |
| 011 |  | 7 | 45x130 | 3242 |
| 012 |  | 15 | 45x130 | 330 |
| 013 |  | 1 | 45x130 | 3242 |
| 014 |  | 7 | 45x130 | 1036 |
| 015 |  | 7 | 45x130 | 906 |
| 016 |  | 1 | 45x130 | 5170 |
| 017 |  | 2 | 45x130 | 5170 |
| 018 |  | 8 | 45x123 | 516 |
| 019 |  | 2 | 45x130 | 3213 |
| 020 |  | 2 | 45x130 | 3273 |
| 021 |  | 2 | 45x58 | 243 |
| 022 |  | 2 | 45x130 | 1637 |
| 023 |  | 2 | 45x58 | 243 |
| 024 |  | 1 | 45x65 | 5170 |
| 025 |  | 16 | 45x130 | 5170 |

Teileliste 2

Artikel-Nr.: 847 150

| Nr. | | Stck. | Profil (mm) | Länge (mm) |
|-----|---|-------|-------------|------------|
| GR2 | Rahmen-Fundamentholz  | 2 | 45x90 | 4990 |
| GR1 | Rahmen-Fundamentholz  | 4 | 45x90 | 4900 |
| FB1 | Rahmen-Fundamentholz  | 8 | 45x90 | 4900 |
| PR1 |  Pfetten 490 900 | 2 | 70x170 | 6100 |
| PR2 |  Pfetten 490 900 | 1 | 70x170 | 6100 |
| PR3 |  Pfetten 490 900 | 2 | 70x170 | 6100 |
| | WINDOW 1290x996 | 2 | | |
| | DOOR 1588x2050 | 1 | | |
| 1 | Screws/Schrauben/Vis 5x100 mm- For fixing first row of wall logs /Fixierung des ersten Bohlenkranzes/Pour fixer les lamesde plancher  | 6 | | |
| 2 | Nails/Nägel/Clous 2.1x50 - For fixing floorboards/ Befestigung Fussbodenbretter/Pour fixer les lames de plancher  | 495 | | |
| 3 | Nails/Nägel/Clous 2.1x50 - For fixing roofboards/ Befestigung Dachbretter/Pour fixer les voliges  | 550 | | |
| 4 | Nails/Nägel/Clous 2.1x50 - For fixing floor edge trims/ Befestigung Fussleisten/Pour fixer les pinthes du plancher  | 30 | | |
| 5 | Nails/Nägel/Clous 2.1x50 - For fixing roofing felt fillet/ Befestigung giebelabschlussbrett/Pour fixer la latte de finition de la couverture  | 20 | | |
| 6 | Screws/Schrauben/Vis 3.5x50 mm- For fixing roof side boards and roof edge reinforcement Befestigung Traufenbretter und Traufenleisten Pour fixer les planches de rive et le tasseau de refrent  | 44 | | |
| 7 | Screws/Schrauben/Vis 3.5x50 mm- For fixing fascia boards and diamonds/ Befestigung Giebelblende und Raute Pour fixer les planches de rive et le diamant  | 28 | | |
| 8 | Screws/Schrauben/Vis 3.5x50 mm- For fixing fwindow and door trims/ Befestigung Fenster und türen/ Pour fixer les croisillons des fenetres et des portes  | 68 | | |
| 9 | Metal storm Brace/Gewindestange/Tige filetee 8 mm  | 4 | | |
| 10 | Shim/Nuts/Mutter ,U-Scheibe/Ecrou/Rondelle 8 mm For fixing storm braces/ Pour fixer les anti tempete/ Für Sturmleisten Pour fixer les croisillons des fenetres et des portes Metal storm Brace/Gewindestange/Tige filetee 8 mm KL1 M8 2,31 m 4 Screws 180 8 pcs. Plastic caps 4 pcs.  | 4/4 | | |

Teileliste 3

Artikel-Nr.: 847 150

| POS | ST. | B | H | L | Teileliste | | |
|-----|--------------------|------|------|-------------------------|--|-----------------------|--|
| FB1 | Vt. spetsi | | | | | FUNDMENTHOLZER | |
| F1 | 24,1m ² | 28 | | 4905 | | FUSSBODENBRETTER | |
| PR | 5 | 70 | 170 | 6100 | | DACHBALKEN | |
| RB1 | 34,5m ² | 20 | | 2830 | | DACHBRETTER | |
| R1 | 4 | 20 | 120 | 3050 | <small>Vaata katuse kaldenurka</small> | Traufenbretter | |
| R2 | 4 | 45 | 65 | 3050 | <small>Vaata katuse kaldenurka</small> | Traufenbretter | |
| R3 | 4 | 20 | 120 | 3000 | <small>Vaata katuse kaldenurka</small> | Giebelabschlussleiste | |
| R4 | 4 | 20 | 90 | 3000 | | Giebelabschlussleiste | |
| DR1 | 1 | 1588 | 2050 | | | | |
| WN1 | 2 | 1290 | 996 | | | | |
| P1 | 21m | 20 | 40 | | | Fußbodenleiste | |
| P2 | 1+1 | 20 | 90 | 1890 | | Türleiste DR1 | |
| P3 | 2+2 | 20 | 90 | 2030 | | Türleiste DR1 | |
| P4 | 2+2 | 20 | 90 | 1590 | | Fensterleiste WN1 | |
| P5 | 4+4 | 20 | 90 | 1150 | | Fensterleiste WN1 | |
| P6 | 2+2 | 20 | 90 | 1230 1260 | | Fensterleiste WN1 | |

Wandplan 1

Art.-Nr. 847 150

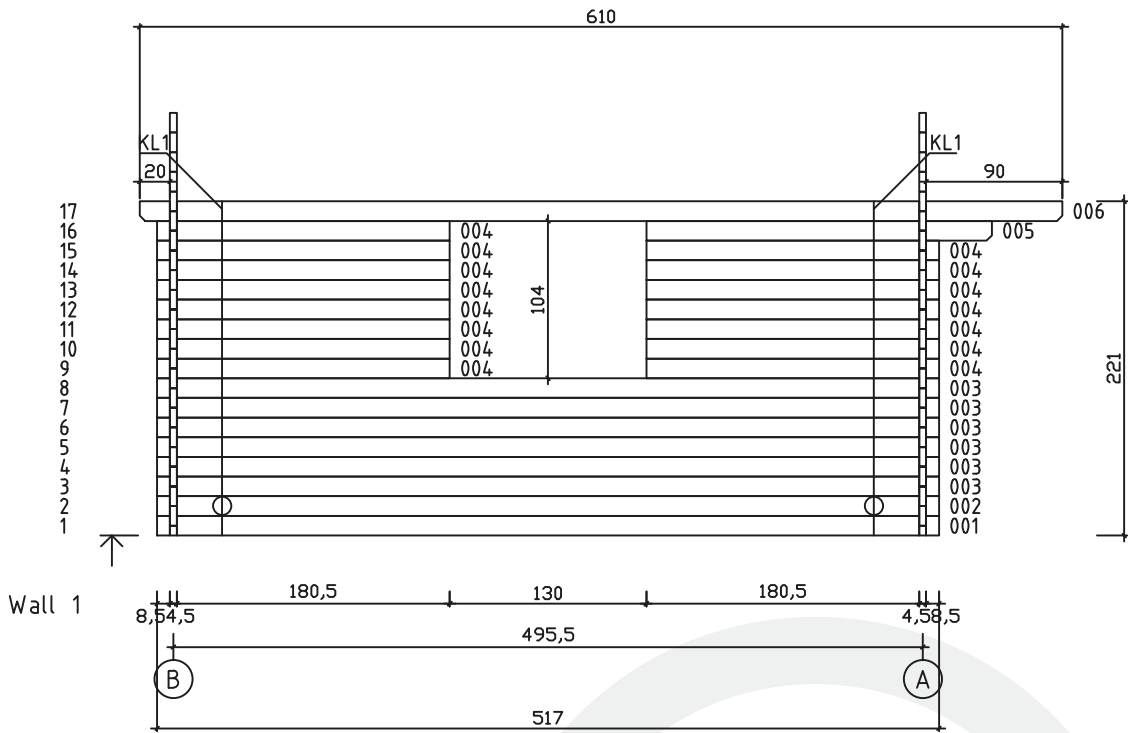

Wandplan 2

Art.-Nr. 847 150

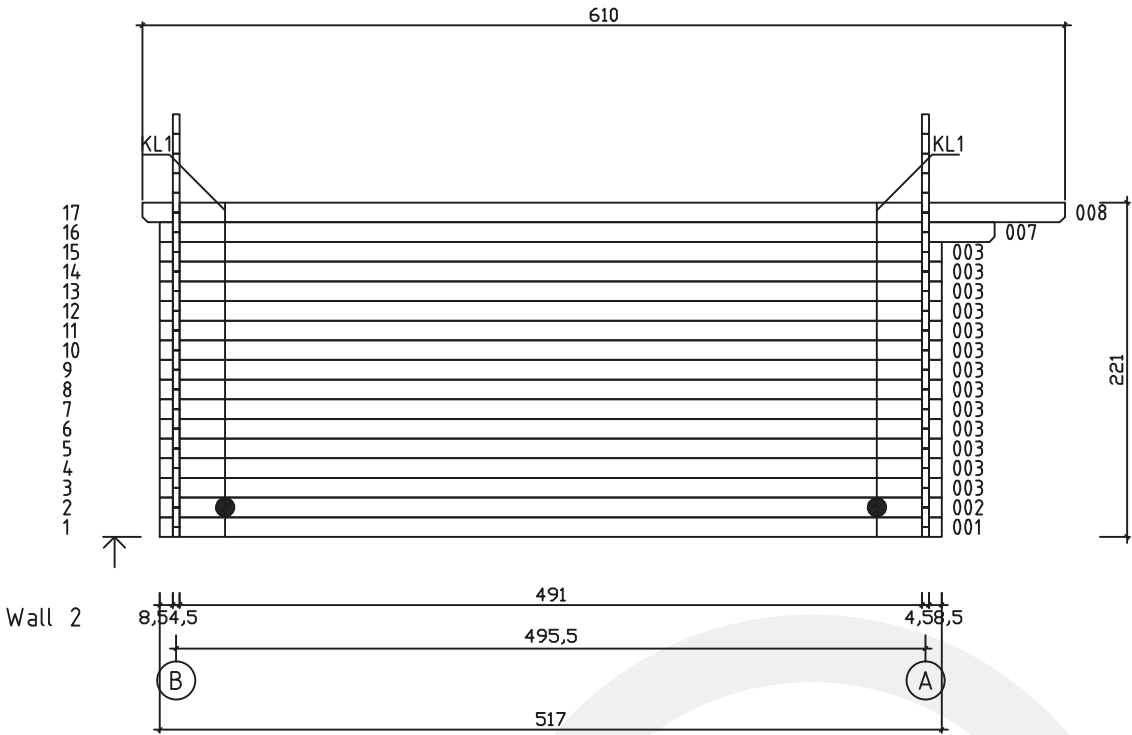

Wandplan A

Art.-Nr. 847 150

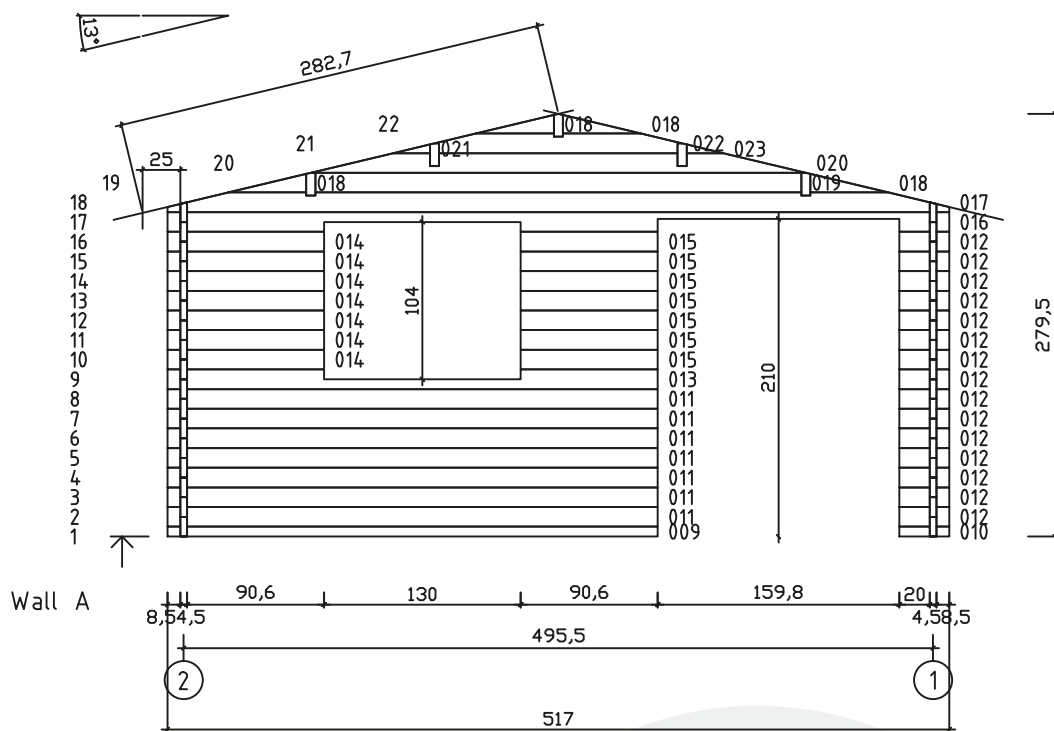

Wandplan B

Art.-Nr. 847 150

