

Technische Daten

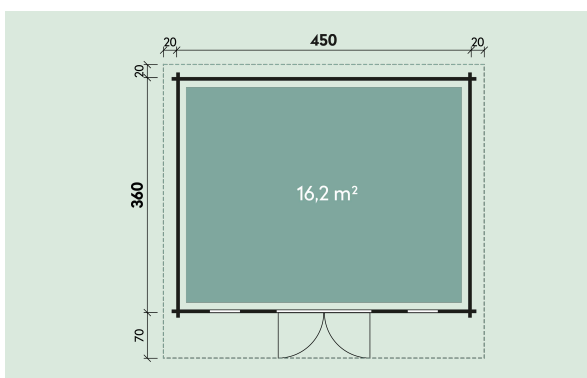

Artikelnummer:

846 230, 831 391, 831 392, 831 393, 831 394



Kontrolliert durch:

3D-Darstellung und Grundriss

846 230, 831 391, 831 392, 831 393, 831 394

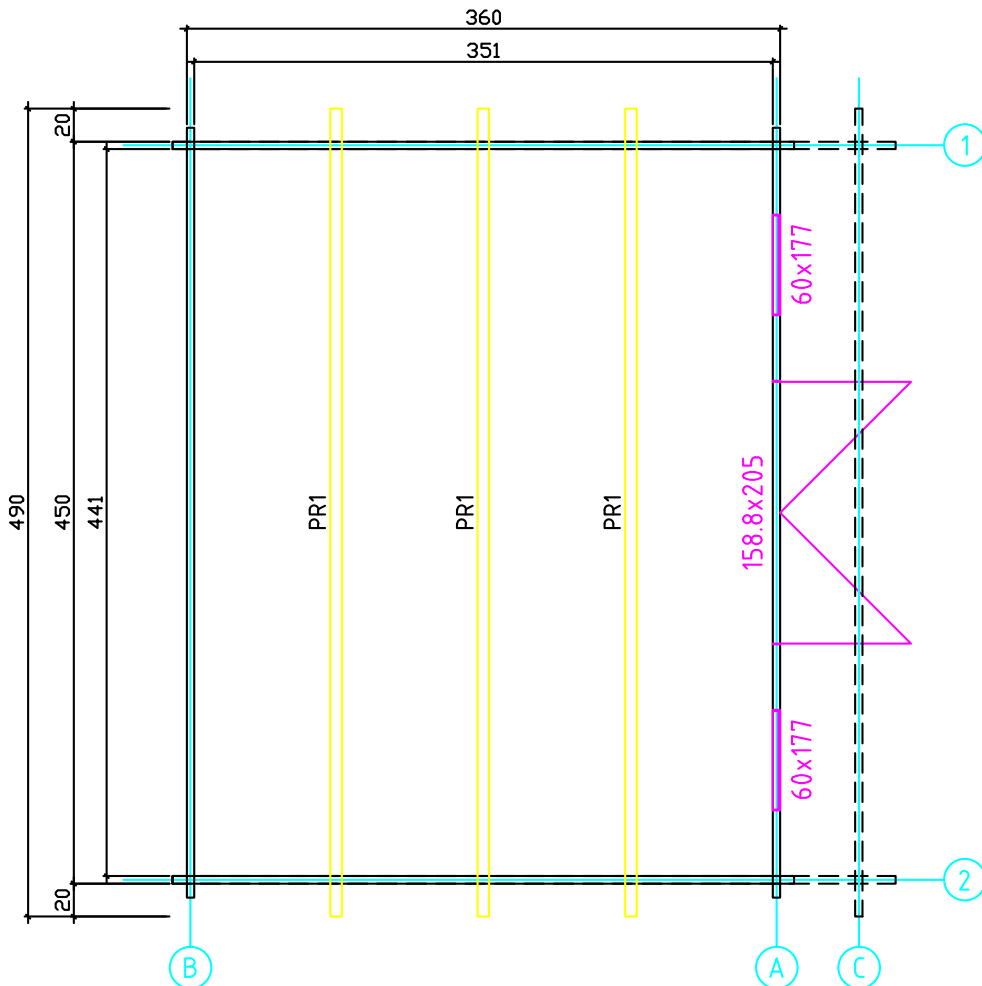
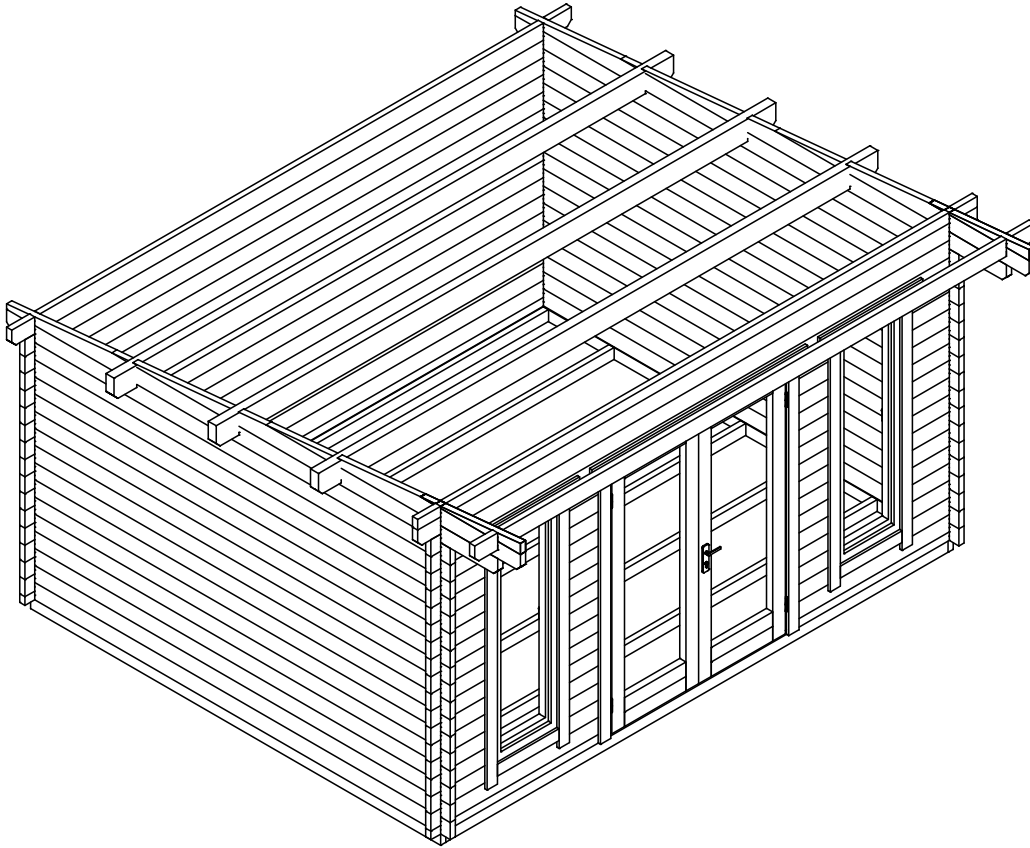

Lagerholzplan und Fundamentplan





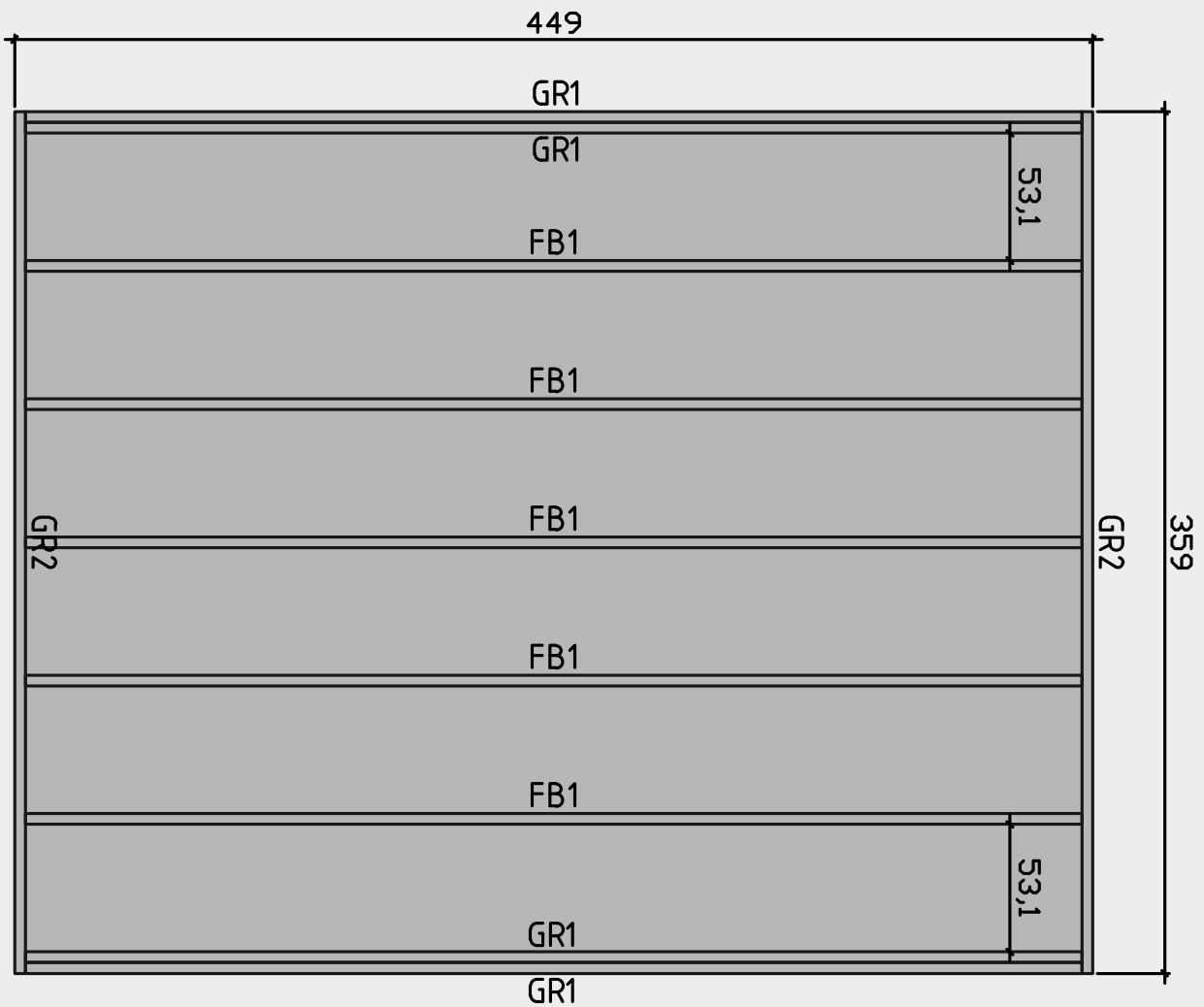





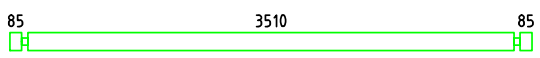
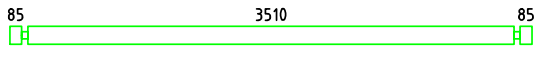
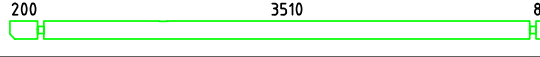

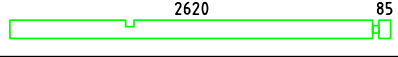
846 230, 831 391, 831 392, 831 393, 831 394

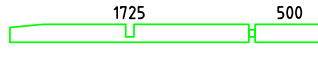
Wir empfehlen als Fundament für Ihr Gartenhaus eine vollflächig festgegründete, gepflasterte oder betonierte Fläche.
Wahlweise ist auch ein Punkt- oder Streifenfundament möglich.

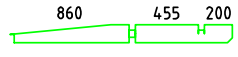

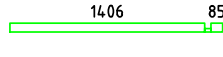
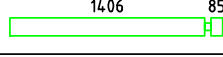
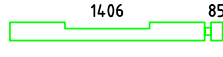

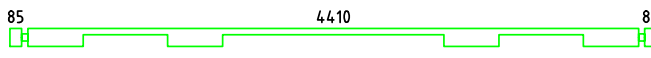
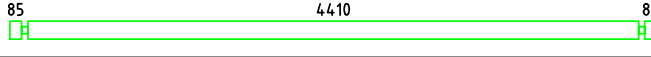
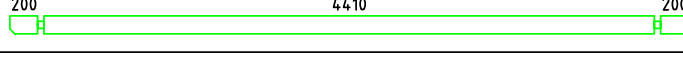
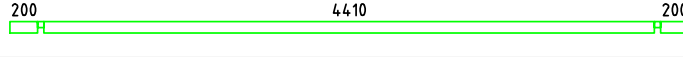
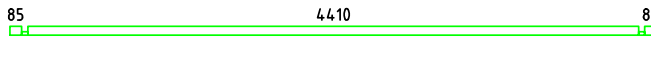
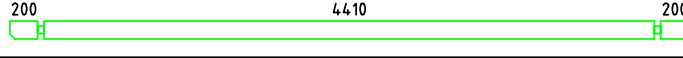
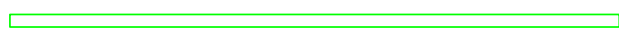



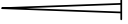

Teileliste 1

846 230, 831 391, 831 392, 831 393, 831 394

Pos		Quantity	Profil (mm)	Lenght (mm)
001		2	45x130	3770
002		28	45x130	3770
003		2	45x130	3885
004		2	45x130	1075
005		2	45x130	2750
006		2	45x15	154
007		2	45x101	865
008		2	45x130	2270
009		2	45x57	593
010		2	45x130	1605
011		2	45x84	876
012		2	45x65	1536
013		2	45x130	1536
014		2	45x130	1536
015		26	45x130	528
016		26	45x130	398
017		1	45x130	4670
018		16	45x130	4670
019		1	45x130	4900
020		1	45x82	4900
021		1	45x65	4670
022		2	45x130	4900
GR1	GROUNDFRAME 	4	45x90	4400
GR2	GROUNDFRAME 	2	45x90	3590
FB1	FLOORBEAMS 	5	45x90	4400

Teileliste 2

846 230, 831 391, 831 392, 831 393, 831 394

Pos		Quantity	Profil (mm)	Lenght (mm)
PR1		3	70x170	4900
	WINDOW 600x1770	2		
	DOOR 1588x2050	1		
1	Screws/Schrauben/Vis 5x100 mm- For fixing first row of wall logs /Fixierung des ersten Bohlenkranzes/Pour fixer les lamesde plancher		6	
2	Nails/Nägel/Clous 2.5x50 - For fixing floorboards/ Befestigung Fussbodenbretter/Pour fixer les lames de plancher		350	
3	Nails/Nägel/Clous 2.5x50 - For fixing roofboards/ Befestigung Dachbretter/Pour fixer les voliges		350	
4	Nails/Nägel/Clous 2.5x50 - For fixing floor edge trims/ Befestigung Fussleisten/Pour fixer les plinthes du plancher		30	
5	Nails/Nägel/Clous 2.5x50 - For fixing roofing felt fillet/ Befestigung giebelabschlussbrett/Pour fixer la latte de finition de la couverture		30	
6	Screws/Schrauben/Vis 2,5x50 mm- For fixing roof side boards and roof edge reinforcement Befestigung Traufenbretter und Traufenleisten Pour fixer les planches de rive et le tasseau de refrent		150	
7	Screws/Schrauben/Vis 2,5x50 mm- For fixing fascia boards and diamonds/ Befestigung Giebelblende und Raute Pour fixer les planches de rive et le diamant			
8	Screws/Schrauben/Vis 2,5x50 mm- For fixing fwindow and door trims/ Befestigung Fenster und türen/ Pour fixer les croissilons des fenetres et des portes			

Teileliste 3

846 230, 831 391, 831 392, 831 393, 831 394

POS	ST.	B	H	L	Teileliste		
FB1	Vt. spetsi					FUNDMENTHOLZER	
F1	15,5m ²	28		3505		FUSSBODENBRETTER	
PR	3	70	170	4900		DACHBALKEN	
RB1	22,2m ²	20		4521		DACHBRETTER	
R1	2	20	140	4940		Traufenbretter	
R2	2	45	65	4900		Traufenbretter	
R3	2	20	140	4720		Giebelabschlussleiste	
R4	2	20	90	4720		Giebelabschlussleiste	
DR1 WN1	1 2	1588 600	2050 1770				
P1	17m	20	40			Fußbodenleiste	
P2	1+1	20	90	1890		Türleiste DR1	
P3	2+2	20	90	2030		Türleiste DR1	
P4	2+2	20	90	900		Fensterleiste WN1	
P5	4+4	20	90	1920		Fensterleiste WN1	
P6	2+2	20	90	540 570		Fensterleiste WN1	

Wandplan 1 und 2

846 230, 831 391, 831 392, 831 393, 831 394

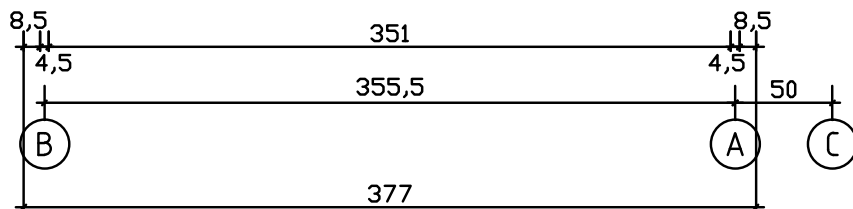
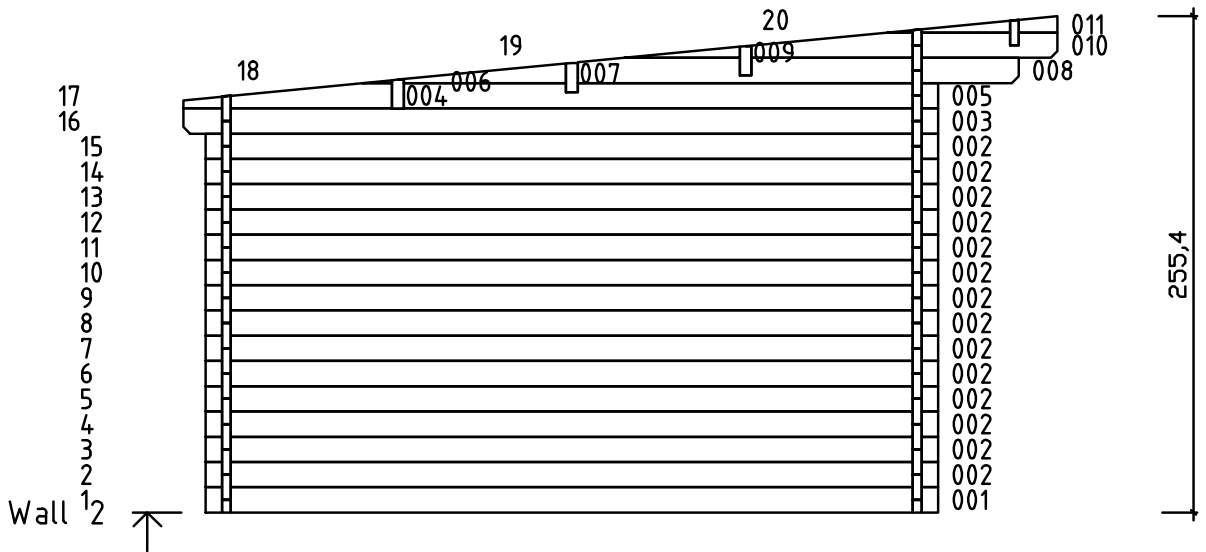
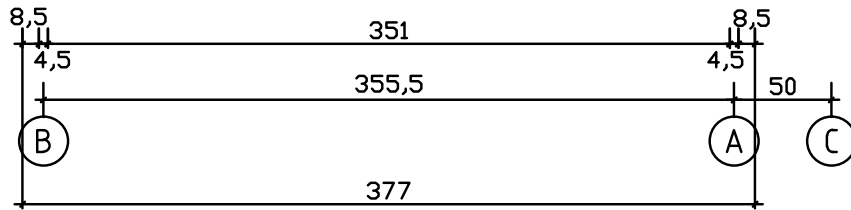
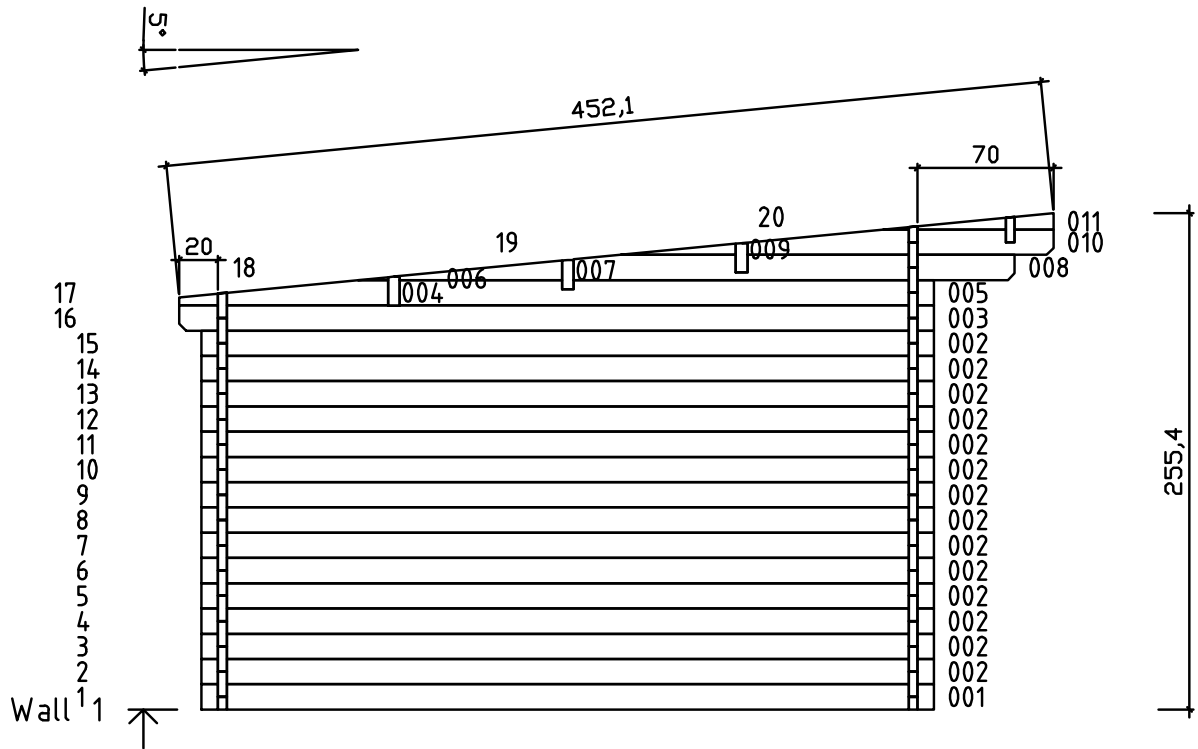

Wandplan A und B

846 230, 831 391, 831 392, 831 393, 831 394

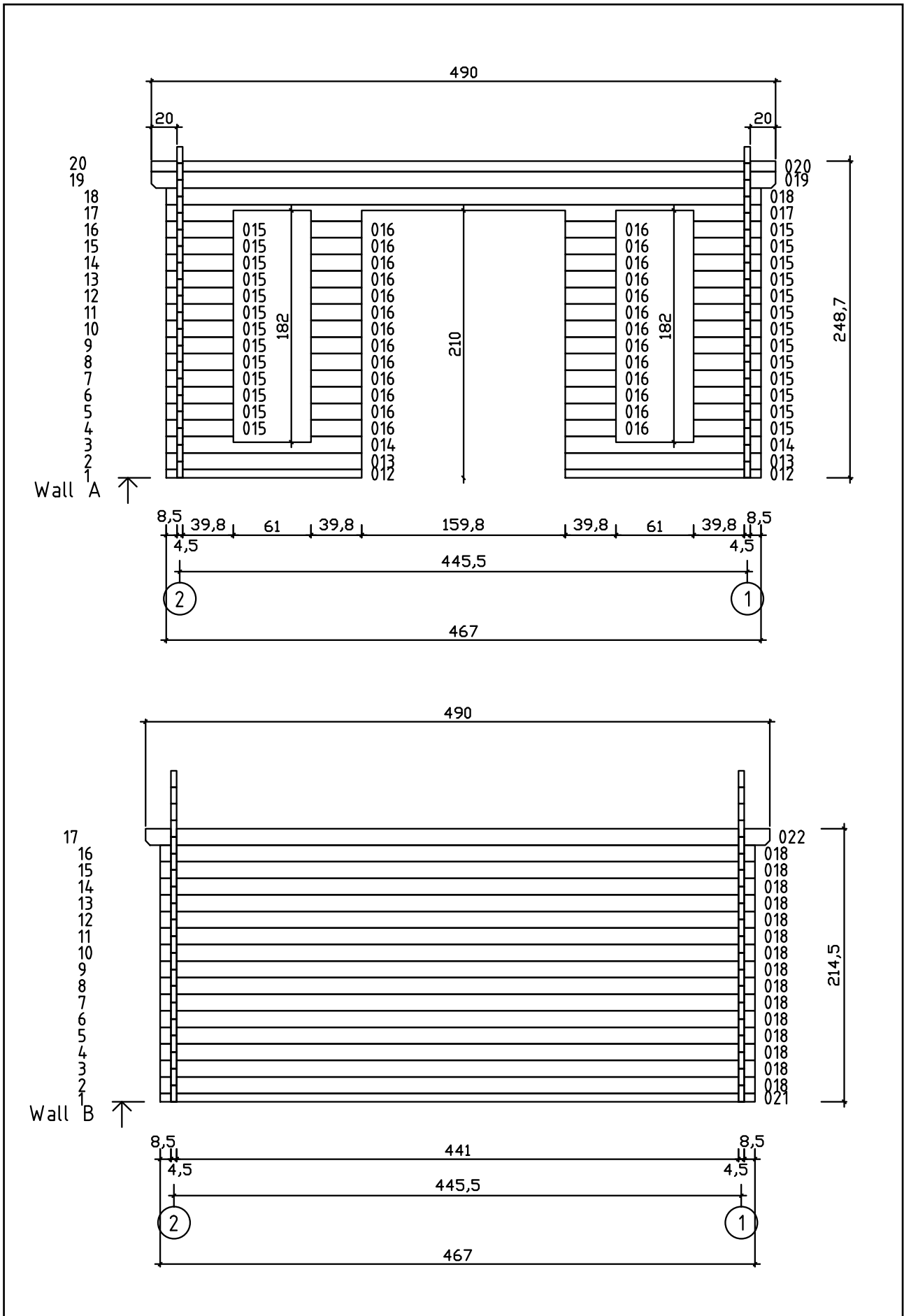

Wandplan C

846 230, 831 391, 831 392, 831 393, 831 394

Vorgelagerte Vordachbohle vor Wand A

