

Technische Daten

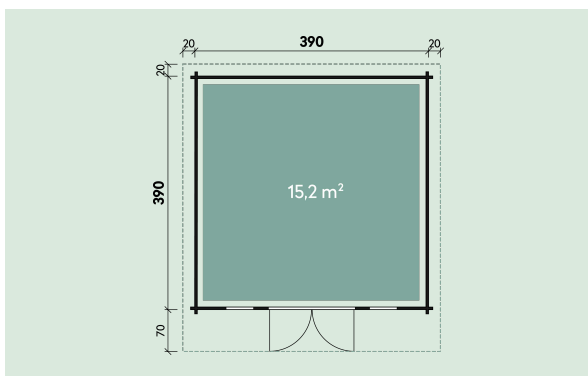

Artikelnummer:

846 220, 831 381, 831 382, 831 383, 831 384



Kontrolliert durch:

3D-Darstellung und Grundriss

846 220, 831 381, 831 382, 831 383, 831 384

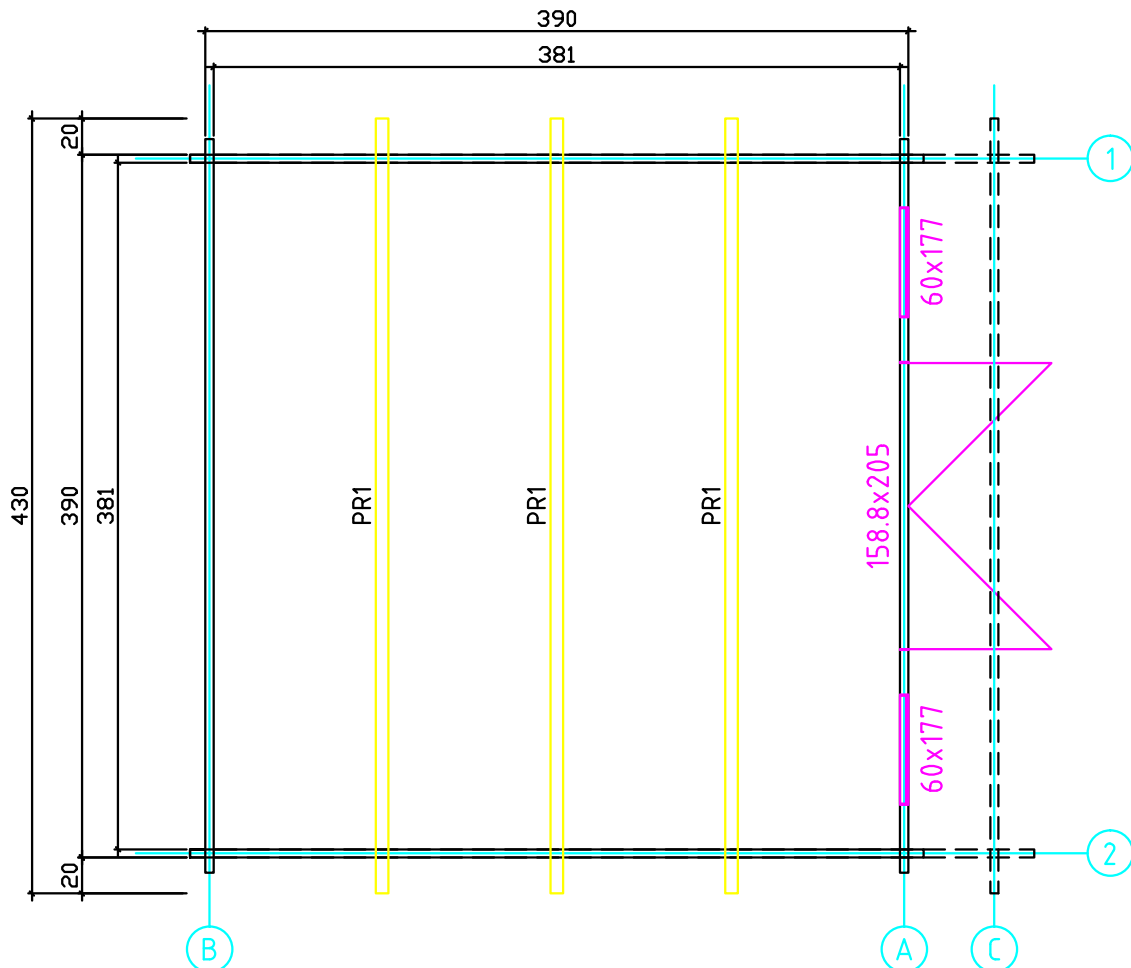
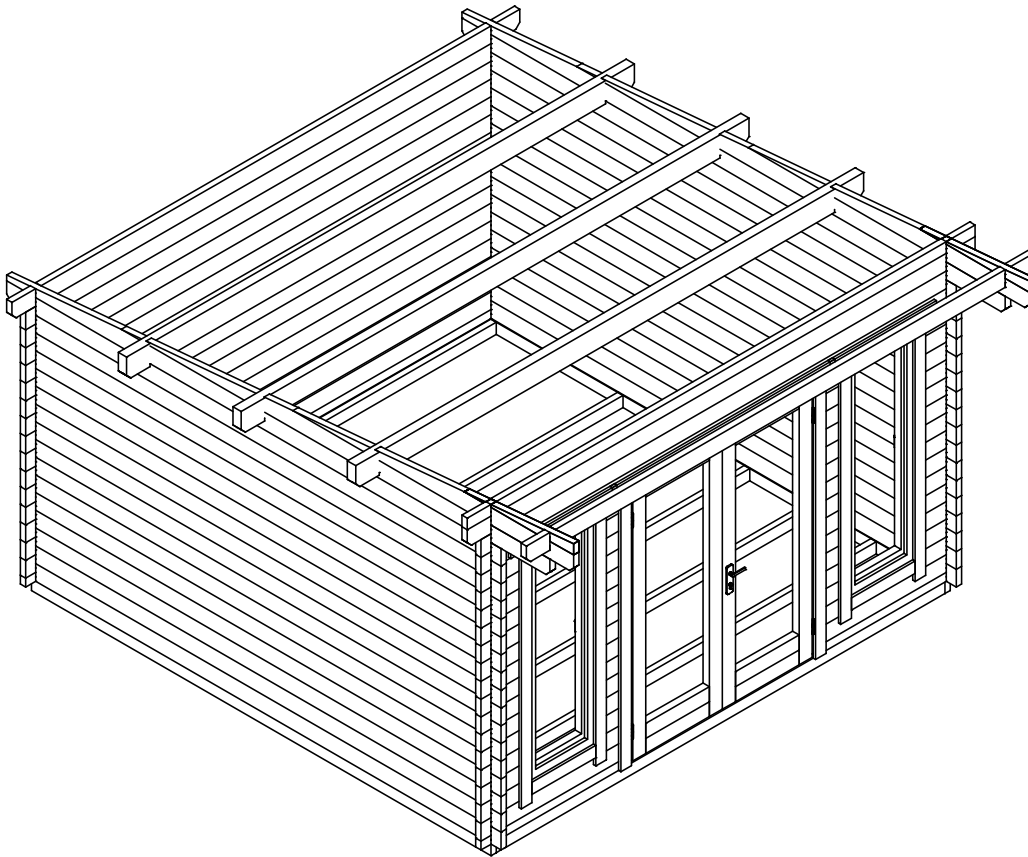

Lagerholzplan und Fundamentplan

846 220, 831 381, 831 382, 831 383, 831 384

Wir empfehlen als Fundament für Ihr Gartenhaus eine vollflächig festgegründete, gepflasterte oder betonierte Fläche.
Wahlweise ist auch ein Punkt- oder Streifenfundament möglich.

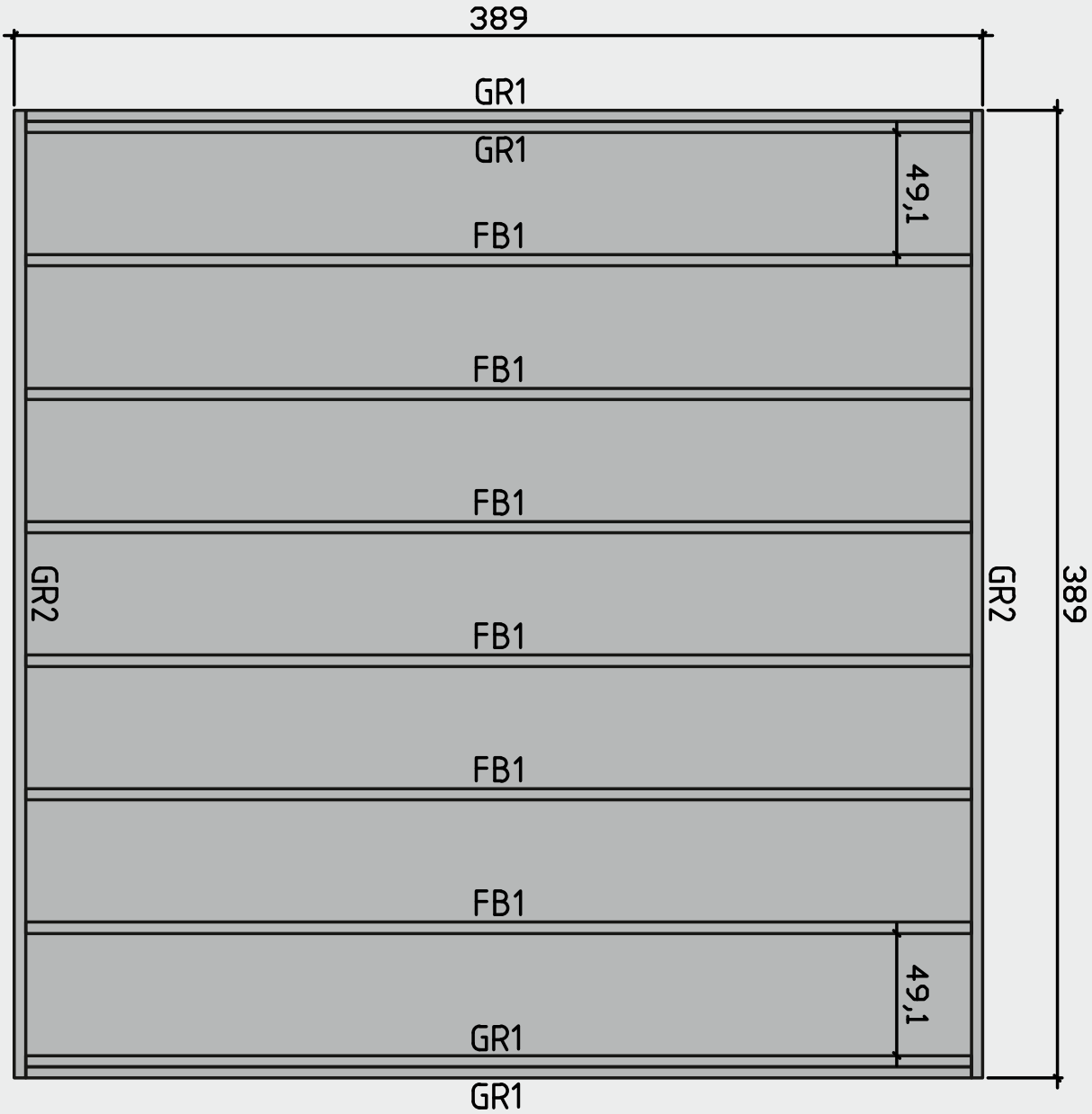

Teileliste 1

846 220, 831 381, 831 382, 831 383, 831 384

| Pos | | Quantity | Profil (mm) | Lenght (mm) |
|-----|--|----------|-------------|-------------|
| 001 | | 2 | 45x130 | 4070 |
| 002 | | 44 | 45x130 | 4070 |
| 003 | | 2 | 45x130 | 4185 |
| 004 | | 2 | 45x130 | 1150 |
| 005 | | 2 | 45x130 | 2975 |
| 006 | | 2 | 45x16 | 179 |
| 007 | | 2 | 45x103 | 940 |
| 008 | | 2 | 45x130 | 2420 |
| 009 | | 2 | 45x60 | 668 |
| 010 | | 2 | 45x130 | 1680 |
| 011 | | 2 | 45x83 | 926 |
| 012 | | 2 | 45x65 | 1236 |
| 013 | | 2 | 45x130 | 1236 |
| 014 | | 2 | 45x130 | 1236 |
| 015 | | 26 | 45x130 | 378 |
| 016 | | 26 | 45x130 | 248 |
| 017 | | 1 | 45x130 | 4070 |
| 018 | | 1 | 45x130 | 4300 |
| 019 | | 1 | 45x85 | 4300 |
| 020 | | 1 | 45x65 | 4070 |
| 021 | | 2 | 45x130 | 4300 |
| GR2 | | 2 | 45x90 | 3890 |
| GR1 | | 4 | 45x90 | 3800 |
| FB1 | | 6 | 45x90 | 3800 |
| PR1 | | 3 | 70x170 | 4300 |

Teileliste 3

846 220, 831 381, 831 382, 831 383, 831 384

| POS | ST. | B | H | L | Teileliste | | |
|------------|--------------------|-------------|--------------|------------|---|----------------------------------|--|
| FB1 | Vt. spetsi | | | | | FUNDMENTHOLZER | |
| F1 | 14,5m ² | 28 | | 3805 | | FUSSBODENBRETTER | |
| PR | 3 | 70 | 170 | 4300 | | DACHBALKEN | |
| RB1 | 20,7m ² | 20 | | 4819 | | DACHBRETTER | |
| *R1 | 2 | 20 | 140 | 4340 | Vaata katuse kaldeurka | Traufenbretter | |
| *R2 | 2 | 45 | 45 | 4300 | Vaata katuse kaldeurka | Traufenbretter | |
| *R3 | 2 | 20 | 140 | 5020 | Vaata katuse kaldeurka | Giebelabschlussleiste | |
| *R4 | 2 | 20 | 90 | 5020 | | Giebelabschlussleiste | |
| DR1 WN1 | 1 2 | 1588 600 | 2050 1770 | | <p style="text-align: center;">P2</p> <p style="text-align: center;">P3</p> <p style="text-align: center;">P4</p> <p style="text-align: center;">P5</p> | | |
| *P1 | 17m | 20 | 40 | | | Fussbodenleiste | |
| *P2 | 1+1 | 20 | 90 | 3800 | | Türleiste DR1, Fensterleiste WN1 | |
| *P3 | 2+2 | 20 | 90 | 2030 | | Türleiste DR1 | |
| *P4 | 4+4 | 20 | 90 | 1920 | | Fensterleiste WN1 | |
| P5 | 2+2 | 20 | 90 | 540 570 | | Fensterleiste WN1 | |

*Wird als Fixlänge geliefert und muss bauseits zugeschnitten werden.

Wandplan 1 und 2

846 220, 831 381, 831 382, 831 383, 831 384

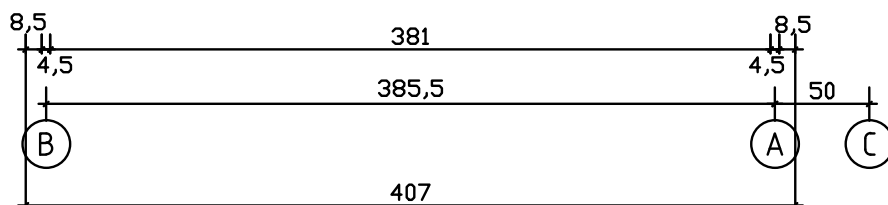
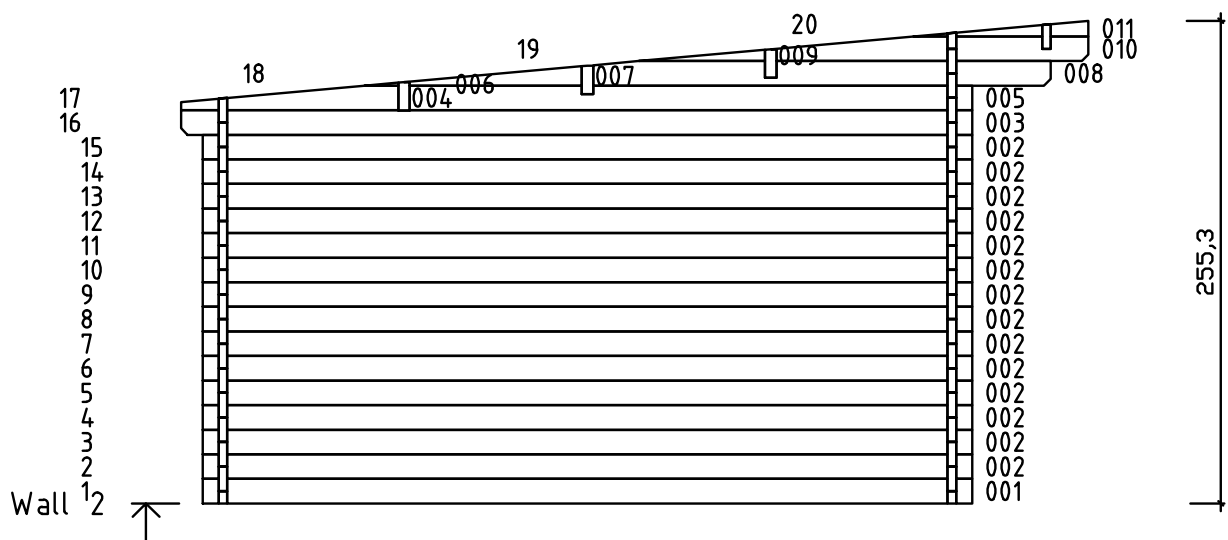
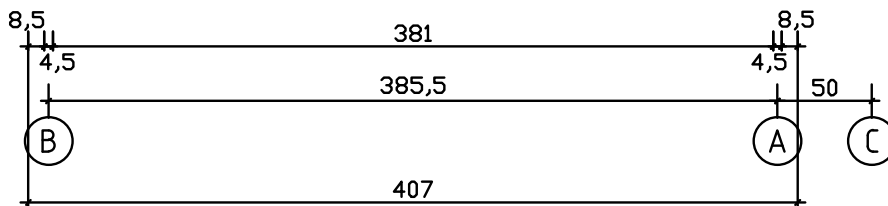
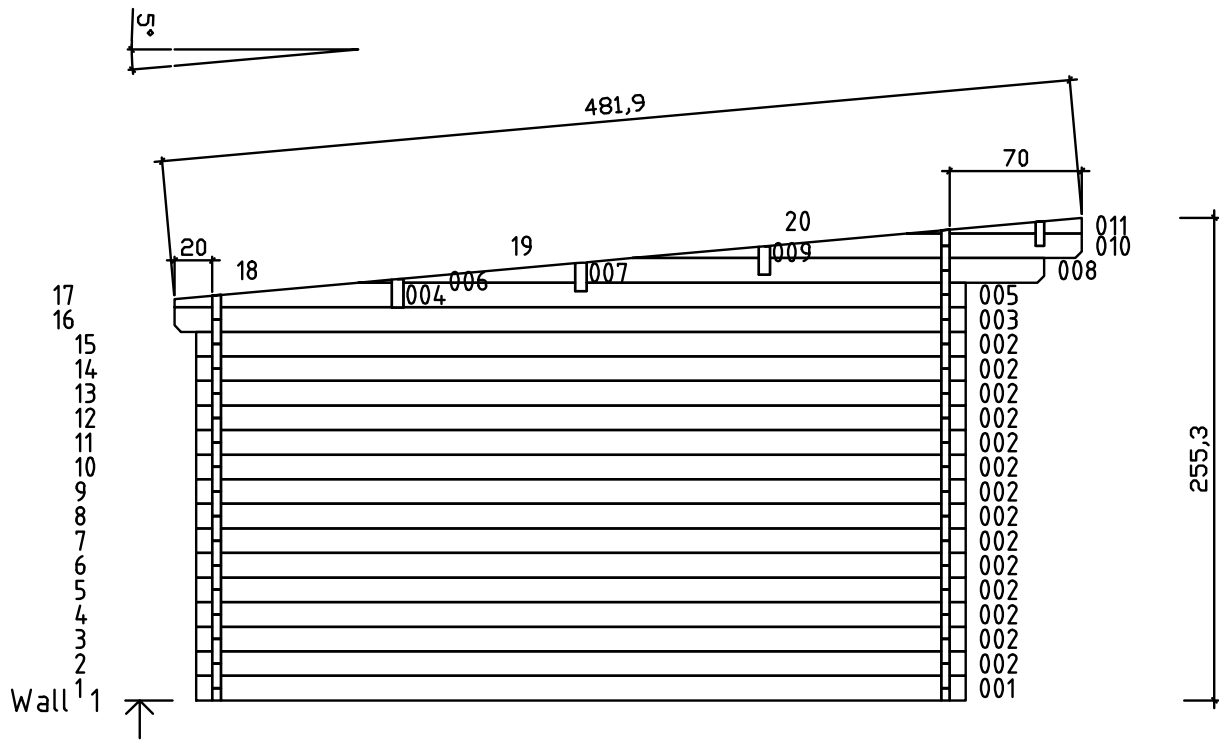

Wandplan C

846 220, 831 381, 831 382, 831 383, 831 384

Vorgelagerte Vordachbohle vor Wand A

